



**Monteringsanvisning**



**Assembly Instructions**



**Monteringsanvisning**

Produkt nr. / Product no. / Produkt nr.

**30-802-020**

**Trestruktur**

Ord. nr. \_\_\_\_\_

Dato. \_\_\_\_\_

Sign. \_\_\_\_\_

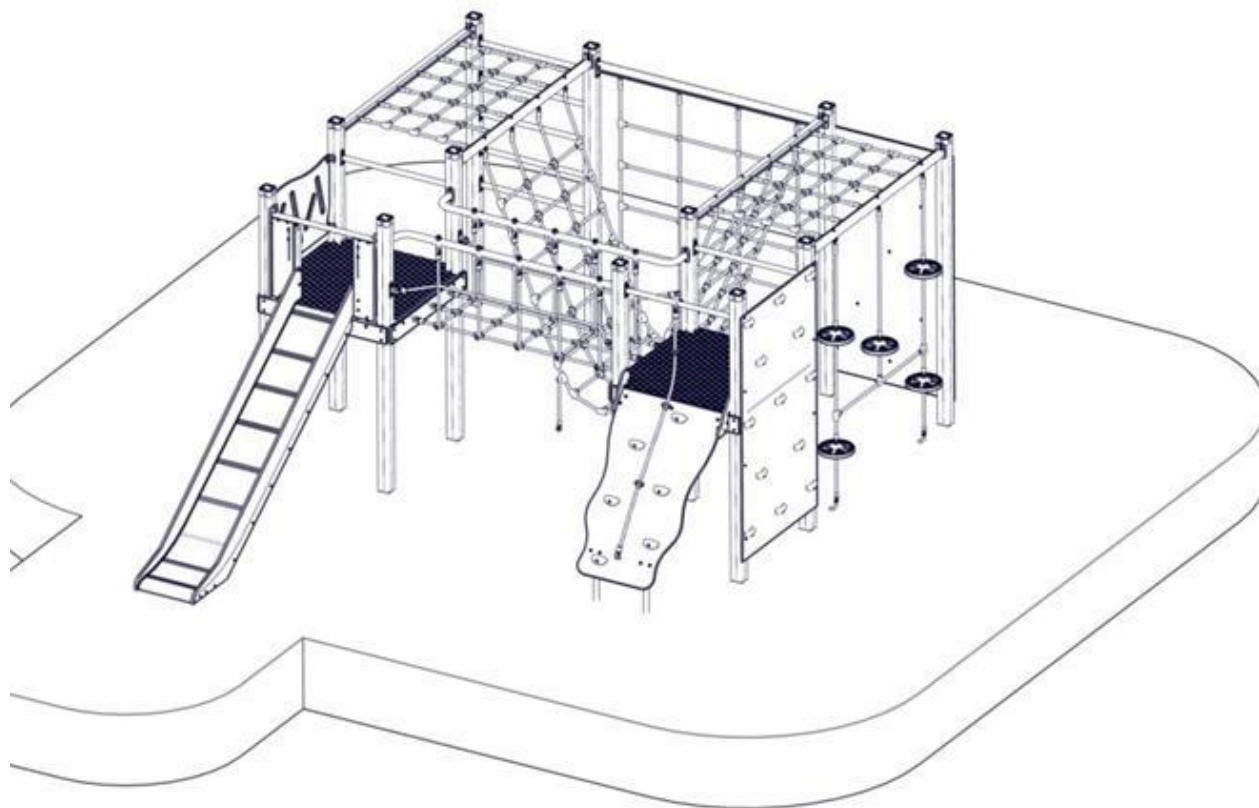

**søve**

Søve AS  
Grønnvoldveien 290  
3830 Ulefoss - Norway  
Tlf: +47 35 94 65 65  
[www.sove.no](http://www.sove.no)



**søve**

Søve AB  
EA Rosengrensgatan 32  
421 31 Västra Frölunda  
Phone: +46 (0)31 773 97 00  
[www.sove.se](http://www.sove.se)

**Monteringstips / Assembly Advice / Monteringsstips****N**

- Les monteringsanvisningen nøye før montering.
- Monter elementene i rekkefølgen som vist.
- Boltene bør ikke skrues for hardt til før alt er montert, vatret og loddet. Skru så boltene til.
- NB! Ved bruk av drill, kan boltene ryke.
- På grunn av at solen kan gjøre rutsjeflaten veldig varm, bør rutsjebanens utløp vende mot nord-øst eller nord-vest.
- Er lekeutstyret plassert i naturlige ferdselstraséer må området sikres mot gjennomgang.
- Innspringningshinder bør vurderes rundt lekeapparater hvor det er stor bevegelse, f.eks. ved huskestativ.
- Det bør være fritt innsyn til lekeutstyr som er beregnet for barn under 3 år.

**NB! Under monteringsarbeidet må utstyr, som ikke er forankret forsvarlig i bakken, sikres slik at det ikke velte.**

**Området må avstenges under montering av apparatene med sperrebånd eller lignende.**

**EN**

- Read the instruction carefully before assembling the play unit.
- Assemble the components in the sequence shown in these instructions. Fixings must not be fully tightened during assembly. Before casting the foundations, the structure must be level and plumb, at which point all fixings are tightened. PS! If use of drill, the bolts may be wrecked.
- Avoid positioning the slide facing due south because of overheating – ideal positions are facing north-east or north-west. Secure the construction-area to prevent people from walking through it.
- Consider installing barriers around play-equipment which gives rise to a lot of activity – i.e. swings.
- Ensure that clear vision is possible across the play area so that supervision is possible from any position, particularly where children under 3 years of age will be playing.

**NB! During assembly of the equipment, ensure that all structures are securely propped, especially when left overnight. Also ensure that equipment is supported**

**Monteringstips / Assembly Advice / Monteringsstips****S**

- Läs monteringsanvisningen noga före montering.

- Montera delarna i den ordningen som anvisas
- Skruvarna bör inte skruvas för hårt tills allt är monterat, i våg och lodat.











OBS! Används elektrisk skruvdragare, kan bulten gå sönder. Hårdra därför manuellt!

- Solen kan göra att rutchbanan blir väldigt varm. Banans nedfart rekommenderas att vändas i norrlig riktning
- Om lekplatsen placeras vid en gångväg mm bör området säkras mot genomfart av gående och cyklister.
- Insprängningshinder bör placeras runt lekutrustning med stor rörelse, t ex, gungställning.
- Det bör vara fri insyn till lekutrustning beräknat till barn under 3 år.

**OBS! Under monteringsarbete bör utrustningen som inte ska förankras i marken, ställs så att den inte kan välta.**

**Området måste spärras när lekutrustningen byggs upp, med avspärrningsband eller liknande.**

**Nødvendig verktøy / Tools required / Nödvändiga verktyg**

<p>(N)</p> <p>(EN)</p> <p>(S)</p>	<p>(A)</p> 	<p>(B)</p>  <p>Torx Nr 45</p>	<p>(C)</p> <p>5 mm 6 mm</p> 	<p>(D)</p> 	<p>(E)</p> 
		<p>Metermål Metric measure Tumstock</p> 	<p>Ø11mm Bor Ø11mm Drill Ø11mm Borr</p> 	<p>Merkebånd Mark ribbon Märkeband</p> 	<p>13 + 17mm</p> 

**Nødvendig antall personer / Number of persons required / Rekommenderad antal personer**





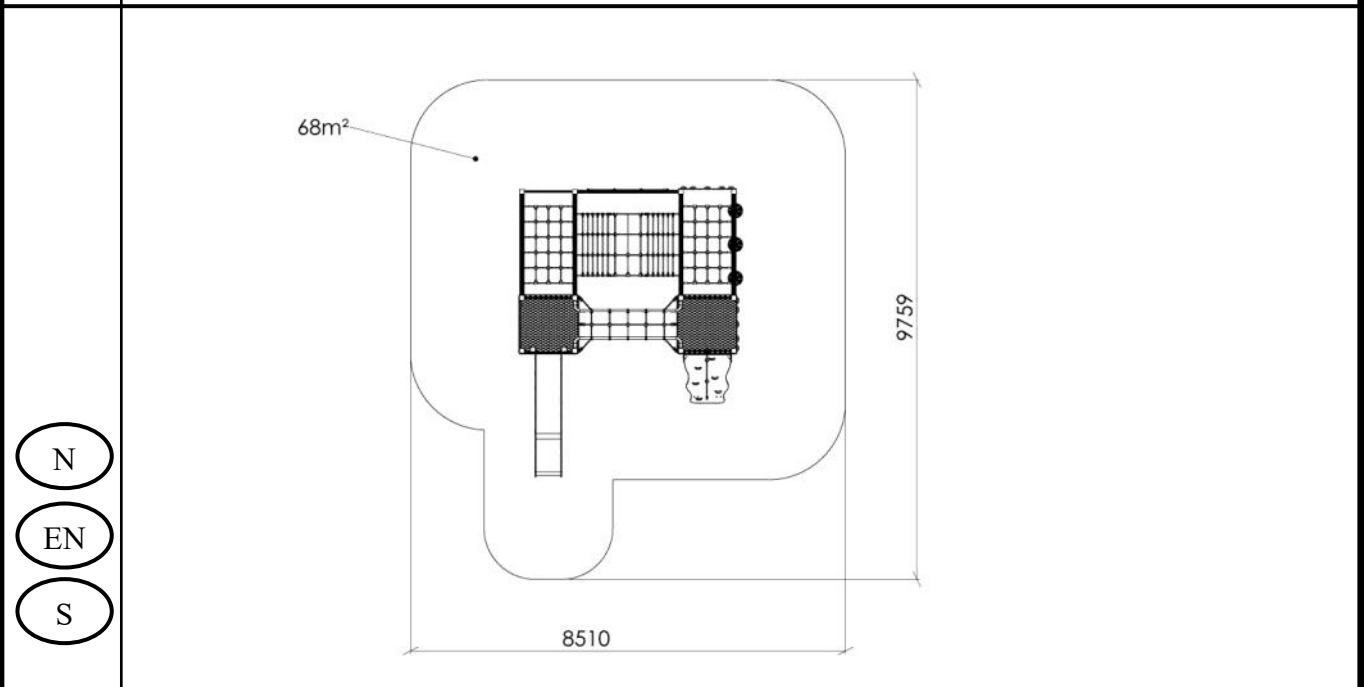



**Anbefalt arealbehov ved montering / Recommended working space / Rekommenderad arealbehov vid montering**

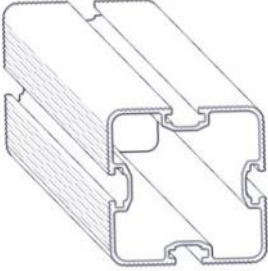









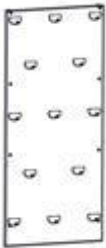

**Boltepakker for / Boltpackage for / Bultpaket för**

Sign. \_\_\_\_\_

Fjelltind 30-802-020	Navn	Artnr/ dimensjon	Ant	Lev
	Stolpe 95x95 600-2430 Lengde = 3030 Sort  Stolpe 95x95 600-2300 Lengde = 2900 Sort	SFA5117/1   SFA5117/1	10   2	
	Endelokk 95x95 Sort	00-400-998	12	
	Gulv P-0-0-0 1160x1160x15 Grå	00-400-299K (se egen delmontering)	1	
	Gulv for klatrevegg 1160x1160x15 Grå	00-400-356K (se egen delmontering)	1	
	Sprosse standard 1130x145x15 Grå	00-400-104K (se egen delmontering)	6	
	Sprosse dobbel 3 hull cc265 1130x145x15 Grå	00-400-123K (Se egen delmontering)	2	





<b>Boltepakker for / Boltpackage for / Bultpaket för</b>		Sign. _____		
<b>Fjelltind 30-802-020</b>	<b>Navn</b>	<b>Artnr/ dimensjon</b>	<b>Ant</b>	<b>Lev</b>
	Sperrerør 940x120 Sort	00-400-156K (Se egen delmontering)	9	
	Klatrevegg Trestuktur	00-400-718K (se egen delmontering)	2	
	Brua Sort	07-500-047K (se egen delmontering)	1	
	Taknett 1500x1000 Sort	05-100-009K (se egen delmontering)	2	
	Alu profil til Nett-tak + U-nett L=1980 Sort m/ dekkhylse montert	00-400-820K (se egen delmontering)	2	
	Alu profil til Nett-tak + dekknett L=1980 Sort m/ dekkhylse montert	00-400-824K (se egen delmontering)	1	

<b>Boltepakker for / Boltpackage for / Bultpaket för</b>		Sign. _____		
<b>Fjelltind 30-802-020</b>	<b>Navn</b>	<b>Artnr/ dimensjon</b>	<b>Ant</b>	<b>Lev</b>
	Drager tak nett 6 hull L=1980 Sort m/ dekkhylse montert	00-400-822K (se egen delmontering)	1	
	Alu profil Type I, N-nett L=1980 Sort	00-400-801K (se egen delmontering)	1	
	U-nett Fjelltind Sort	05-103-120K (se egen delmontering)	1	
	Monkey dekknett 5 stk	00-104-501K (se egen delmontering)	1	
	N-nett 1560x2980 Sort	05-156-003K (se egen delmontering)	1	
	Produktmerke	00-100-400 (montert hos Søve)	0	

**Boltepakker for / Boltpackage for / Bultpaket för**

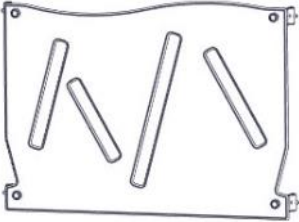
Sign. \_\_\_\_\_.

Fjelltind 30-802-020	Navn	Artnr/ dimensjon	Ant	Lev
	Rekkverk 940x686 Trestruktur	01-125-021K (se egen delmontering)	1	
	Rutsjebane med protal H=1,4m Grå/Trestruktur	40-142-104K (se egen delmontering)	1	
	Opptreksplate cc1035 Grå	01-129-117K (se egen delmontering)	1	



# Fundamentering/foundation

Sign. \_\_\_\_\_

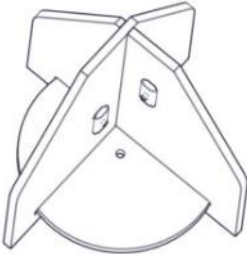
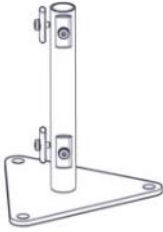
Fjelltind 30-802-020	Navn	Artnr/ dimensjon	Ant	Lev
	<b>Støp/concret</b>			
	Støpefundament 95 x 95 stolpe	00-003-110K (se egen delmontering)	12	
	<b>Nedgravning</b>			
	Nedgravningsfundament 95 x 95 stolpe	00-003-004K (se egen delmontering)	12	
	<b>Overflatemontering</b>			
	Fundament 95x95 stolpe for betongdekke	00-003-125K (se egen delmontering)	12	
	Changed parts Foundations 40-142-104K  01-129-117K  Stolpe må kappes		2  2  12	

**Fundamentering med betong / Foundation concrete / Förankring med betong**

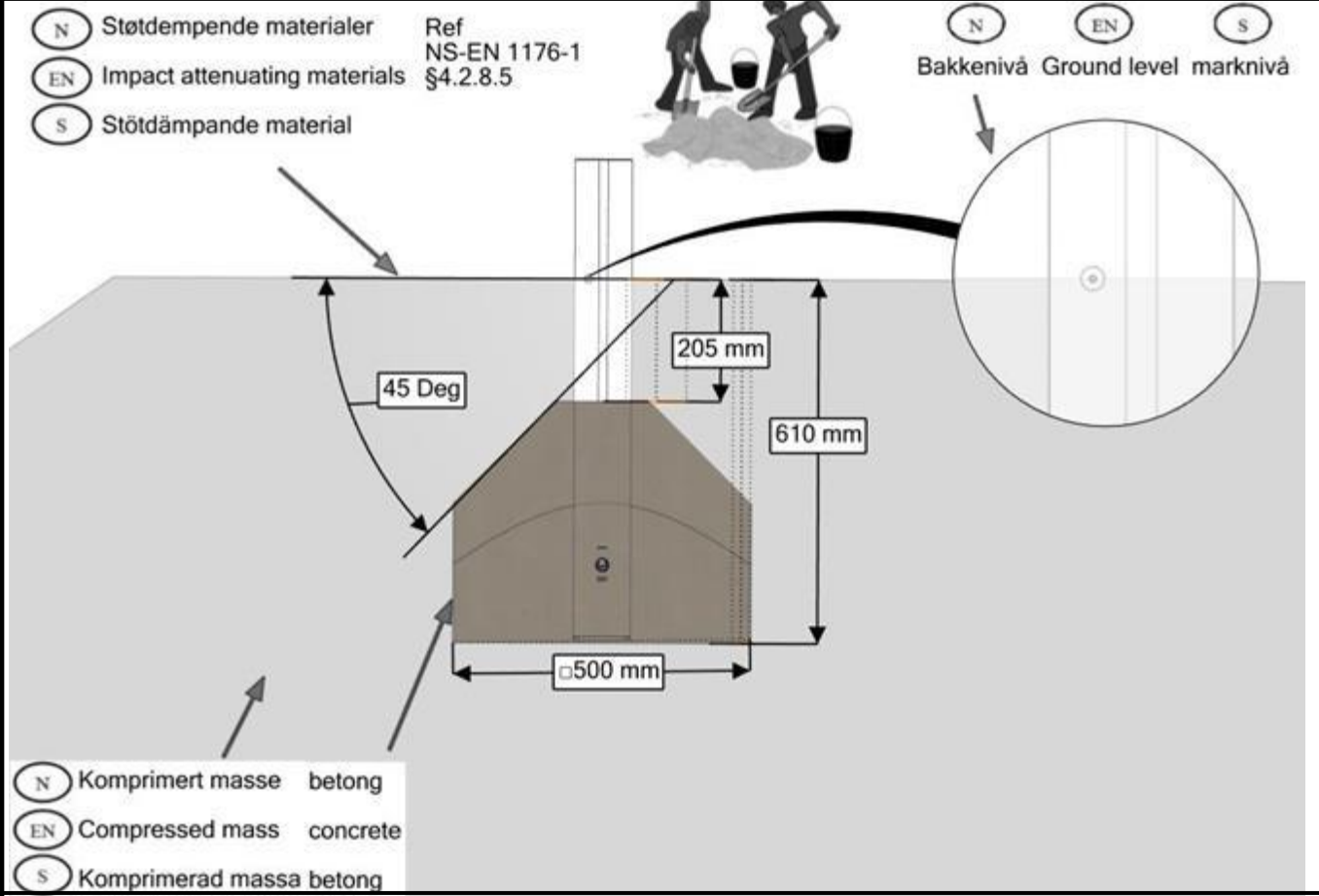

**Fundamentering uten betong / Foundation without concrete / Förankring utan betong**

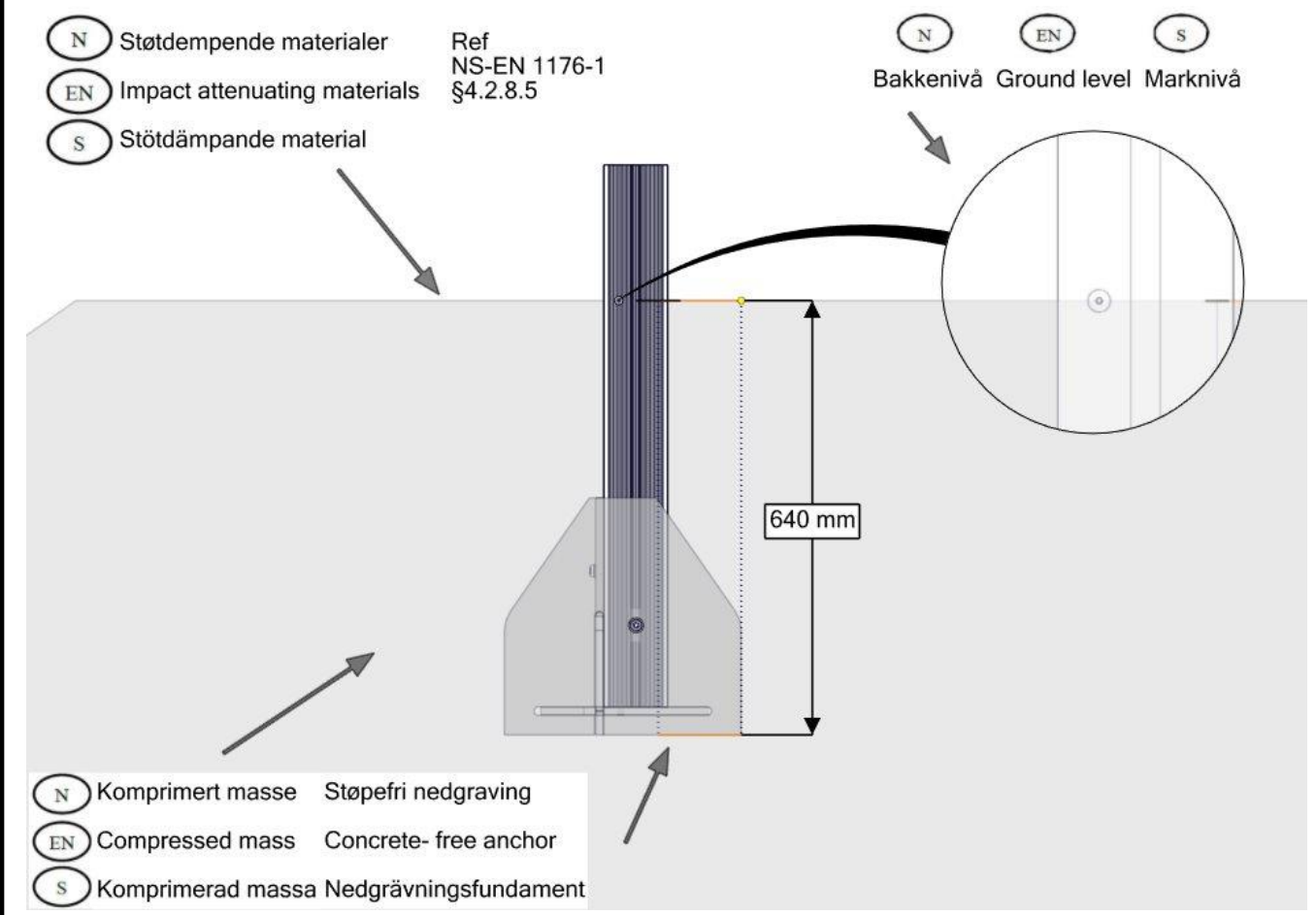

NO	Betongkvalitet	C25/30		
SE	Betongkvalitet			
EN	Concrete quality			
NO	Mengde betong		1,2	m <sup>3</sup>
SE	Mängd betong			
EN	Amount of concrete			
NO	Fundament størrelse		0,5 x 0,5 x 0,4	m
SE	Stiftelsestorlek			
EN	Foundation size			
NO	For sikkerhet må fundamentene med sand eller myk jord være minst 50% større i areal			
SE	För säkerheten måste grunden med sand eller mjuk jord vara minst 50% större i området			
EN	For safety, the foundations with sand or soft soil must be at least 50% larger in area			
NO	Tyngste element	40-142-100	94	Kg
SE	Tyngsta element			
EN	Heaviest element			
NO	Største element	40-142-100	3x0,5x0,4	m
SE	Största element			
EN	Biggest element			

<p>N</p>	<p>Bolten skrues HELT igjennom aluminiumen. Maks moment: 30Nm</p>
<p>EN</p>	<p>The bolt must be tightened in to the post, so that it pierces the aluminium Max torque: 30Nm</p>
<p>S</p>	<p>Bulten skuvas HELT genom aluminiumen. Maks vridmoment: 30Nm</p>

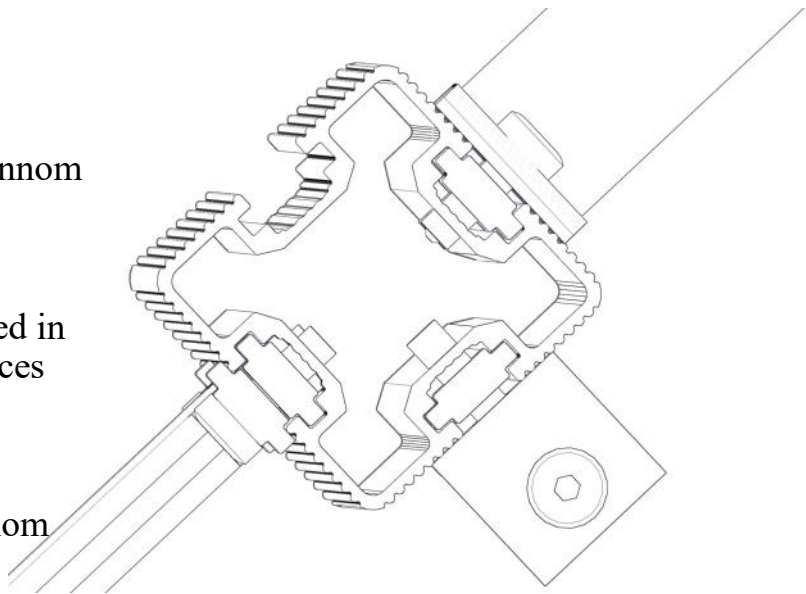

**Sikkerhetssone / Safety zone / Säkerhetszon**

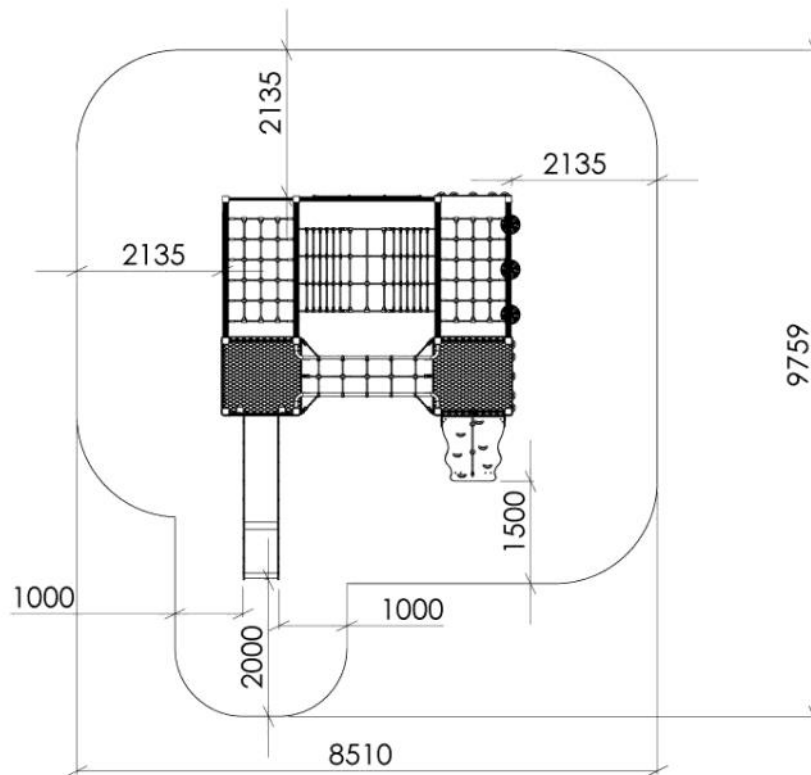

**Plassering av forankringer / Ground plan / Placering av förankringar**

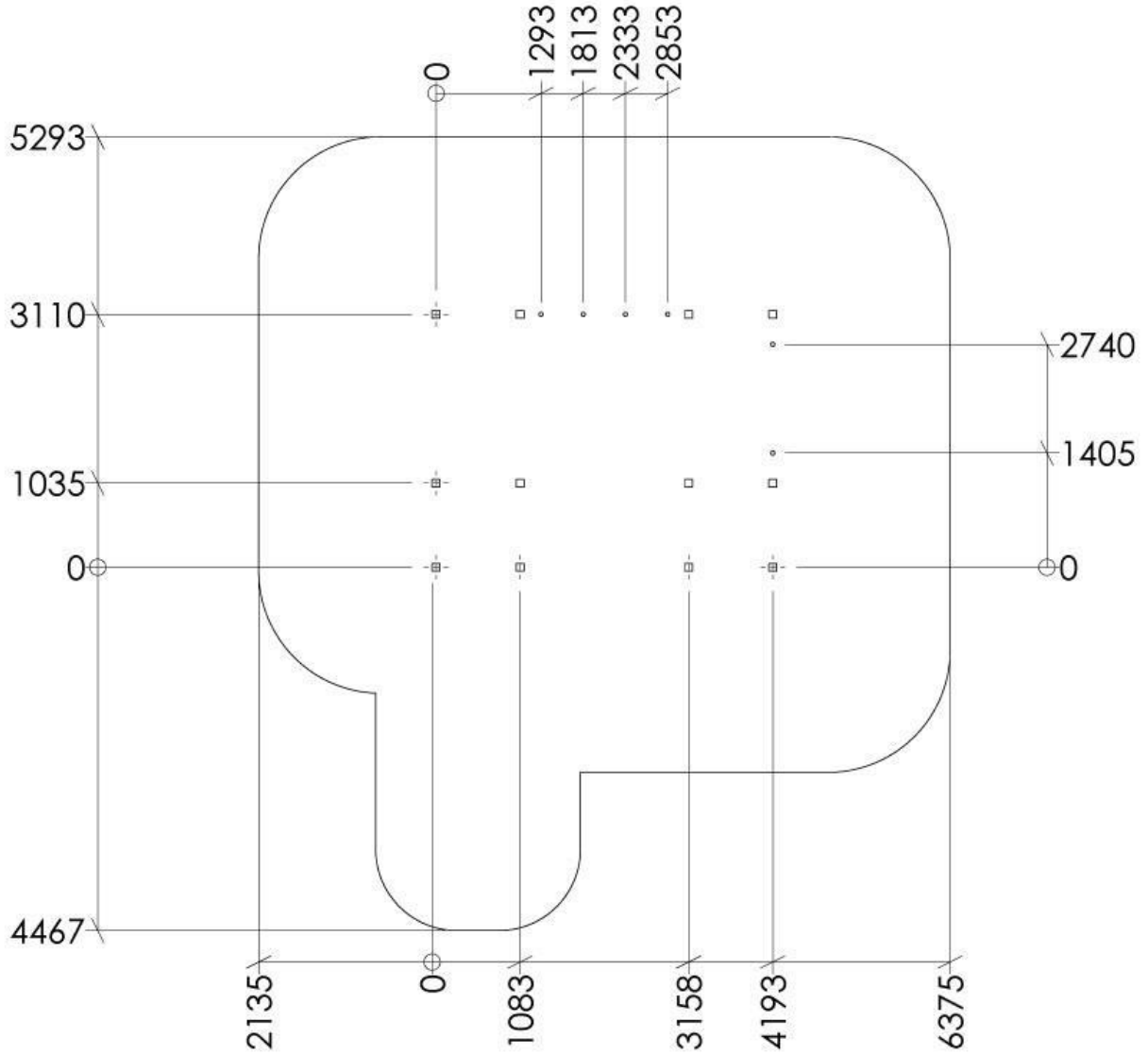

N

Alle mål er oppgitt i millimeter

EN

Scale measured in mm

S

Alla mått är i millimeter.

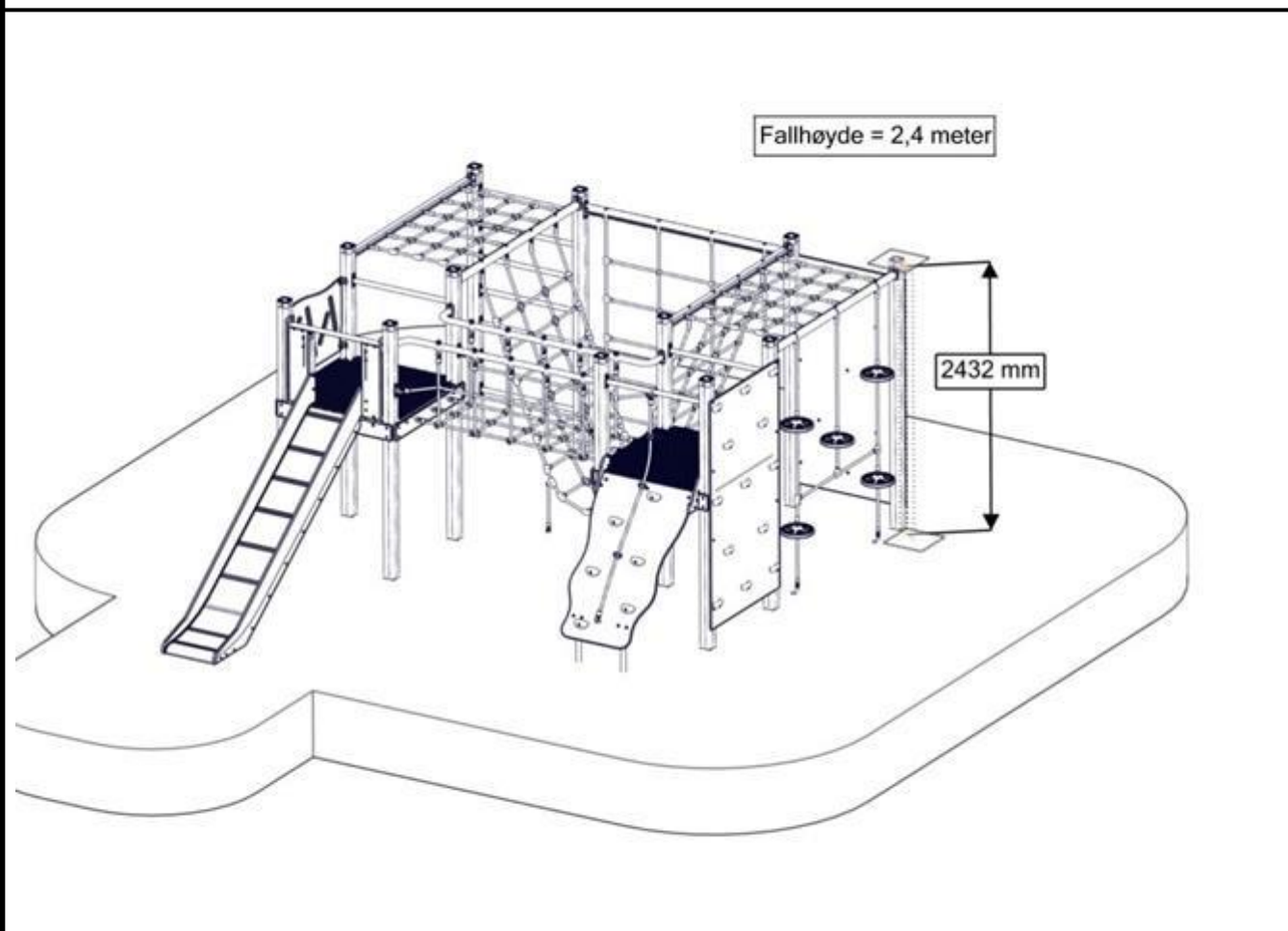
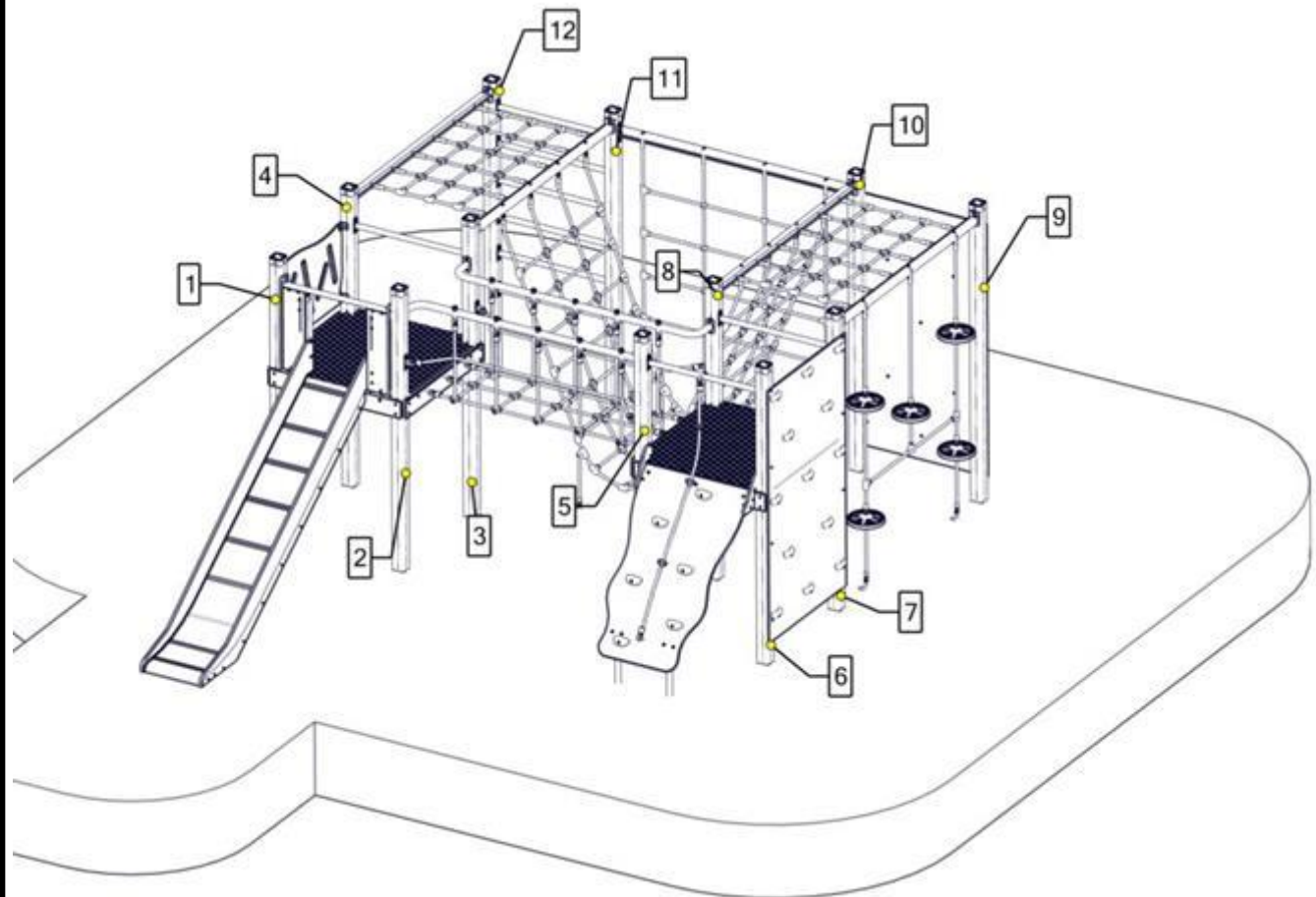
**Montering av lekeapparatet / Assembly instructions / Montering av lekredskapet**



### Montering av lekeapparatet / Assembly instructions / Montering av lekredskapet

Se separat delmontering for detaljer  
 See separate assembly for details  
 Se separata delmontering för detaljer

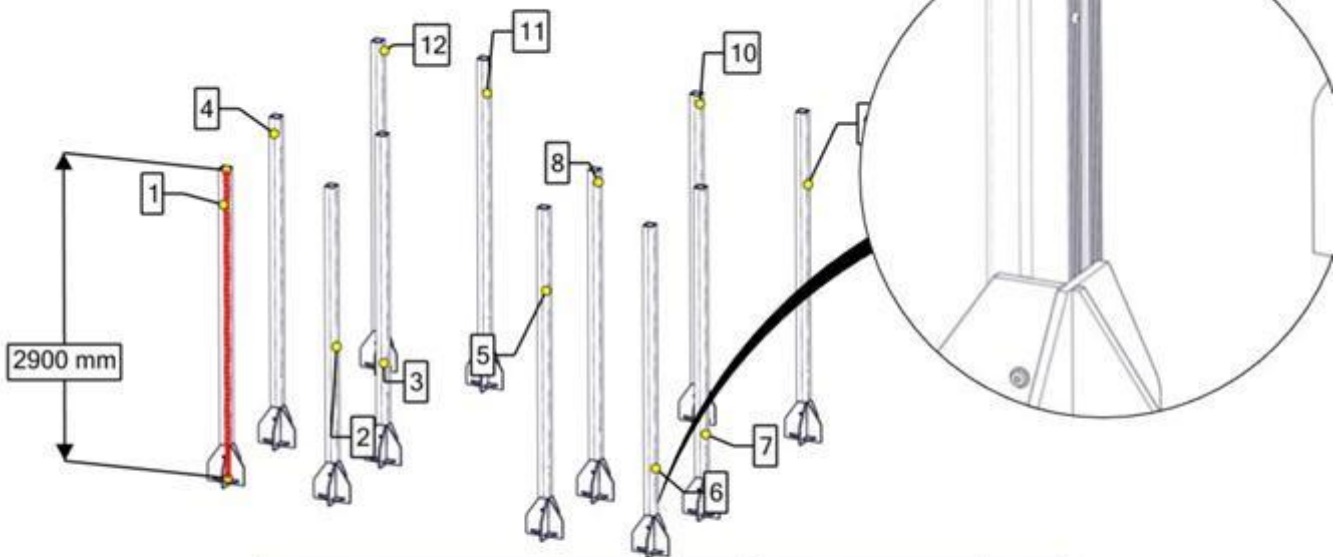

Part Name	Article nr.	Qty
Nedgravingsfundament 95x95	00-003-004K	12
Stolpe 95x95 L=2900	SFA5117/1	2
Stolpe 95x95 L=3030	SFA5117/1	10

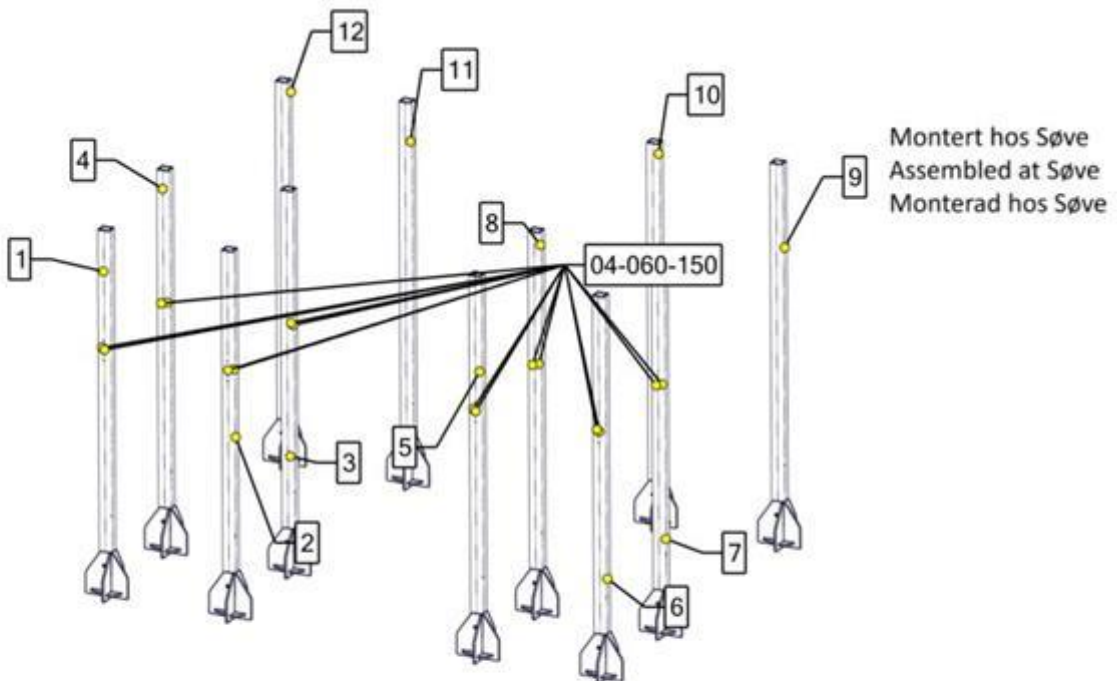

Part Name	Article nr.	Qty
Brikke 150 3xM8	04-060-150	16

## Montering av lekeapparatet / Assembly instructions / Montering av lekredskapet

Se separat delmontering for detaljer  
See separate assembly for details  
Se separata delmontering för detaljer

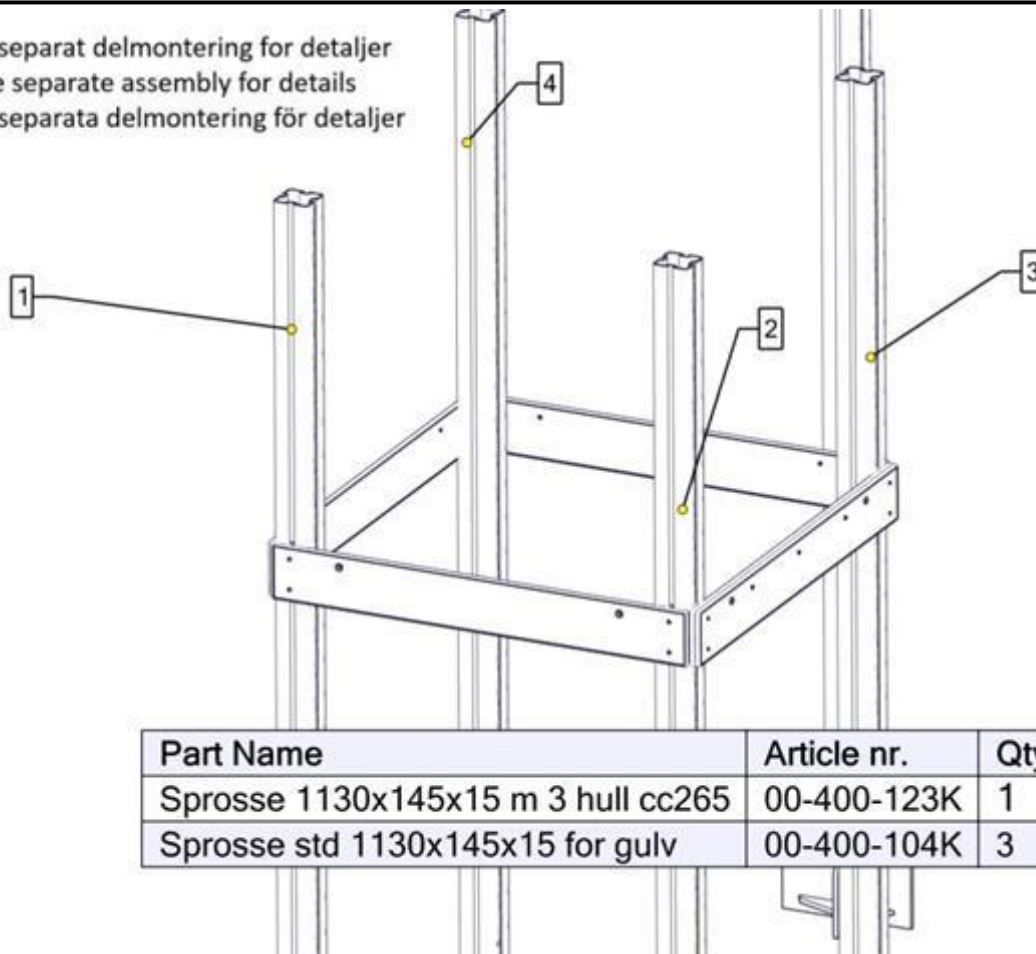

Part Name	Article nr.	Qty
Sprosse 1130x145x15 m 3 hull cc265	00-400-123K	1
Sprosse std 1130x145x15 for gulv	00-400-104K	3

Se separat delmontering for detaljer  
See separate assembly for details  
Se separata delmontering för detaljer

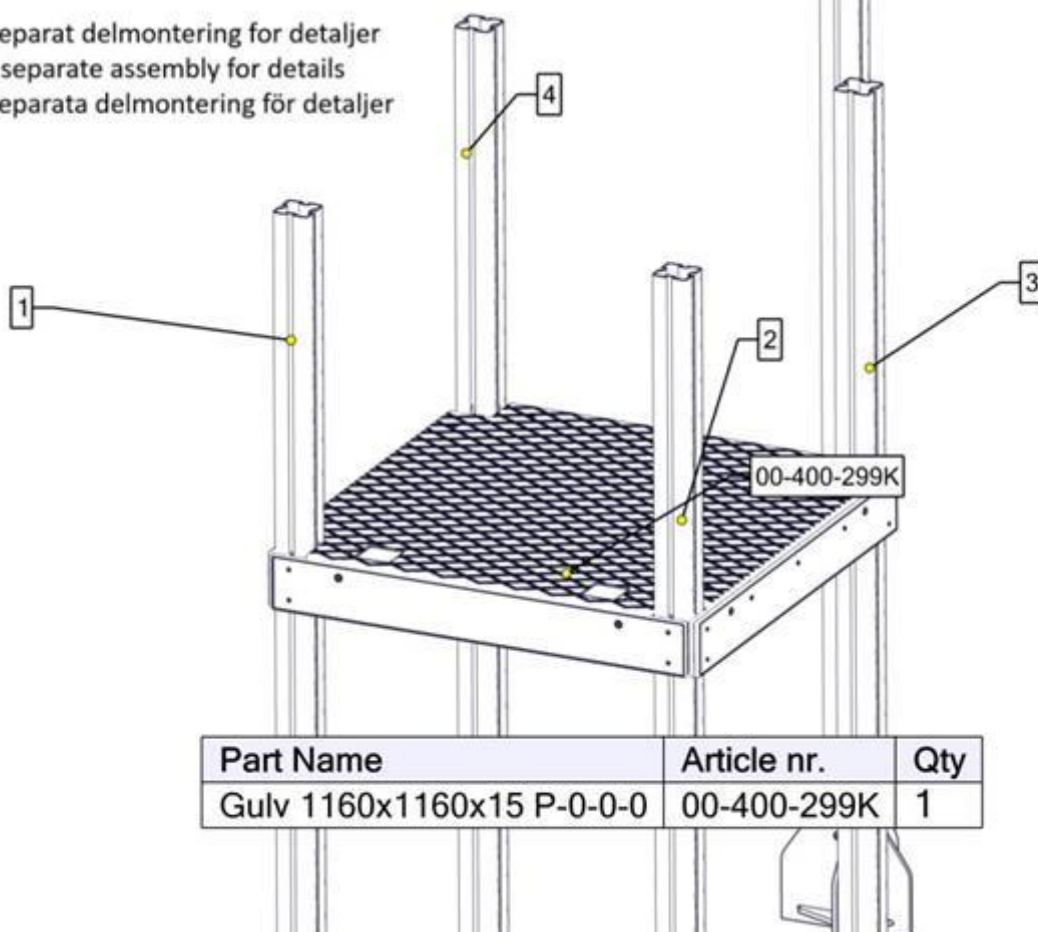

Part Name	Article nr.	Qty
Gulv 1160x1160x15 P-0-0-0	00-400-299K	1

## Montering av lekeapparatet / Assembly instructions / Montering av lekredskapet

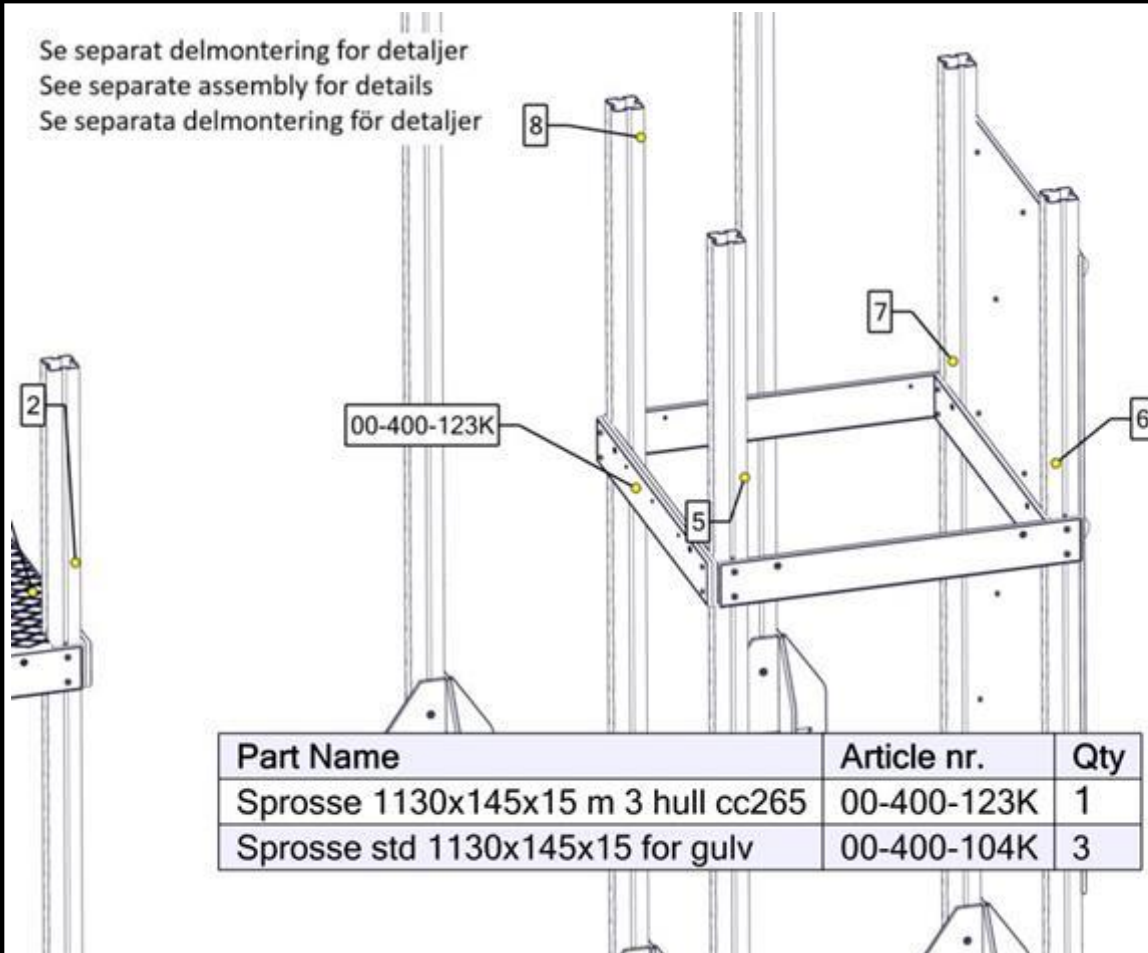
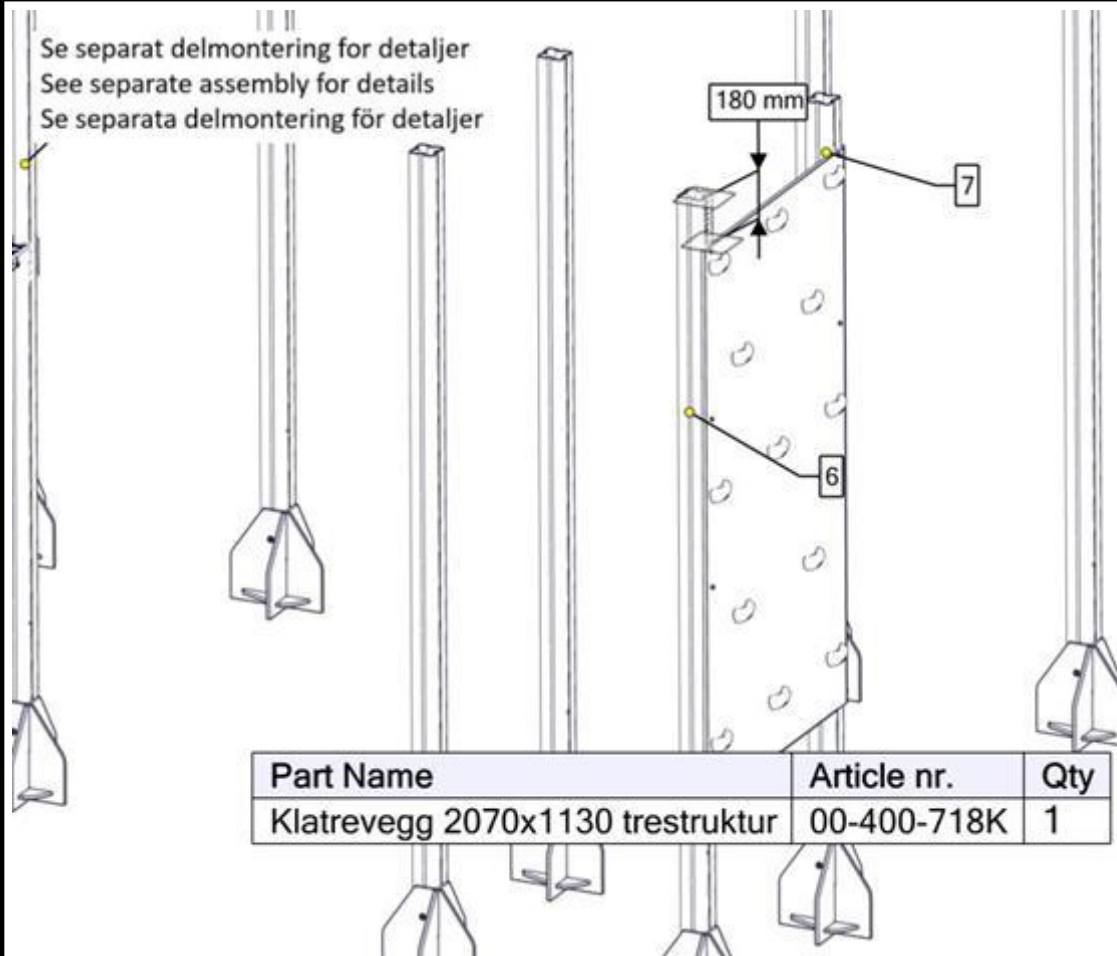



## Montering av lekeapparatet / Assembly instructions / Montering av lekredskapet

Se separat delmontering for detaljer  
See separate assembly for details  
Se separata delmontering för detaljer

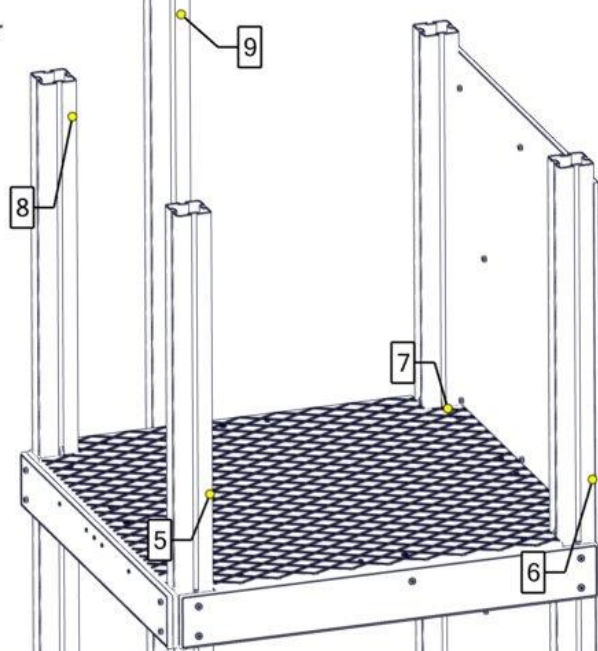

Part Name	Article nr.	Qty
Gulv 1160x1160x15 HPL kappet for klatrev	00-400-303K	1

Se separat delmontering for detaljer  
See separate assembly for details  
Se separata delmontering för detaljer

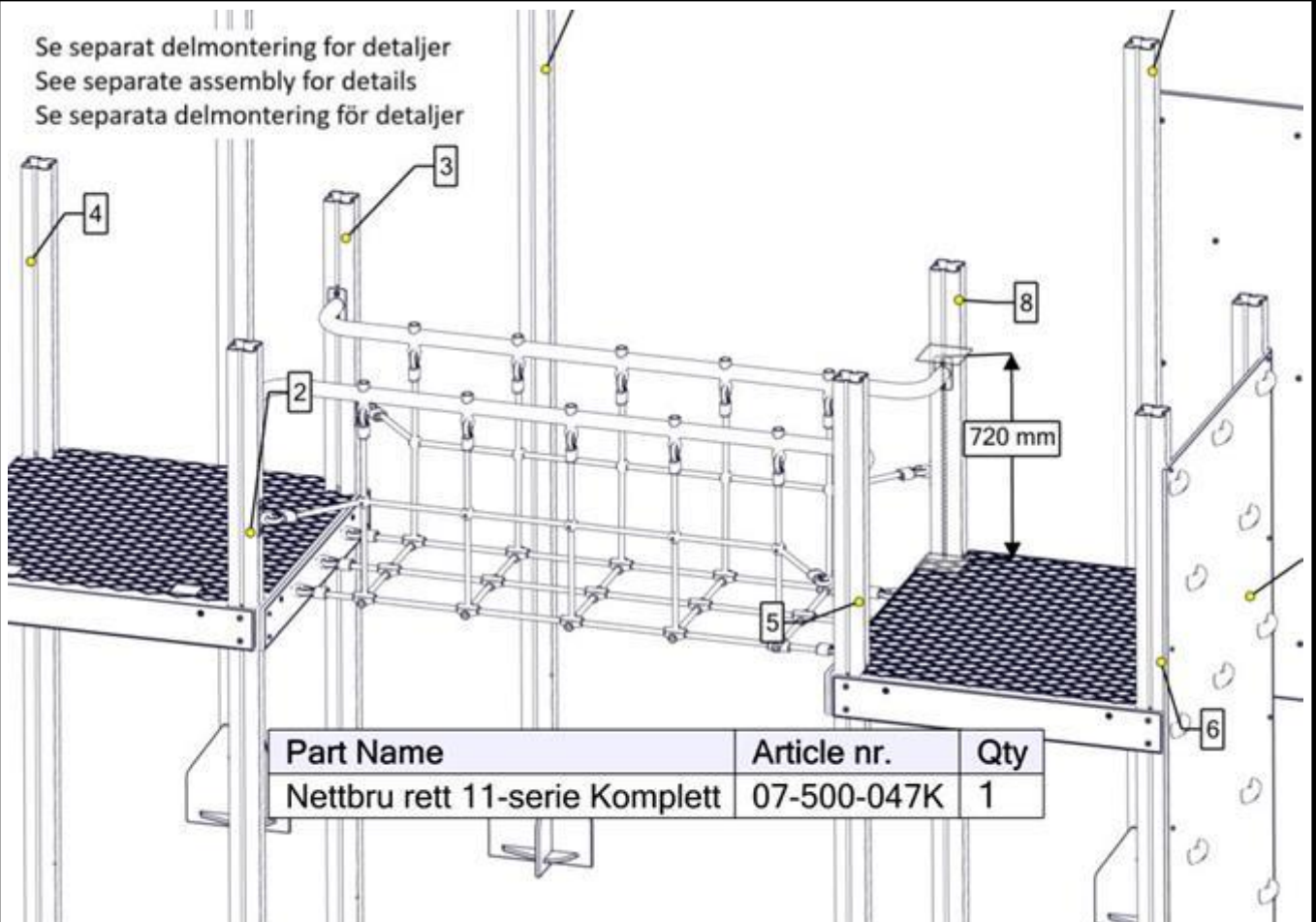

Part Name	Article nr.	Qty
Nettbru rett 11-serie Komplet	07-500-047K	1

# Montering av lekeapparatet / Assembly instructions / Montering av lekredskapet

Se separat delmontering for detaljer  
 See separate assembly for details  
 Se separata delmontering för detaljer

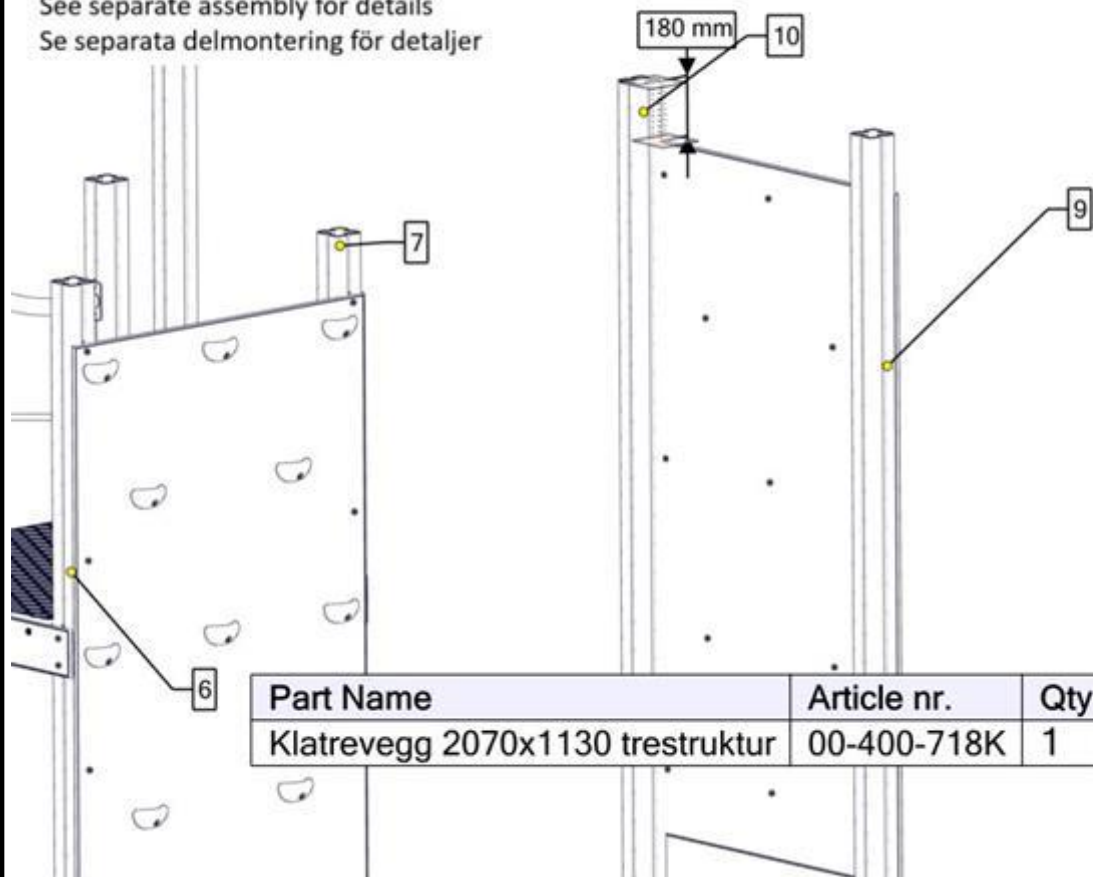

Part Name	Article nr.	Qty
Klatrevegg 2070x1130 trestruktur	00-400-718K	1

Se separat delmontering for detaljer  
 See separate assembly for details  
 Se separata delmontering för detaljer

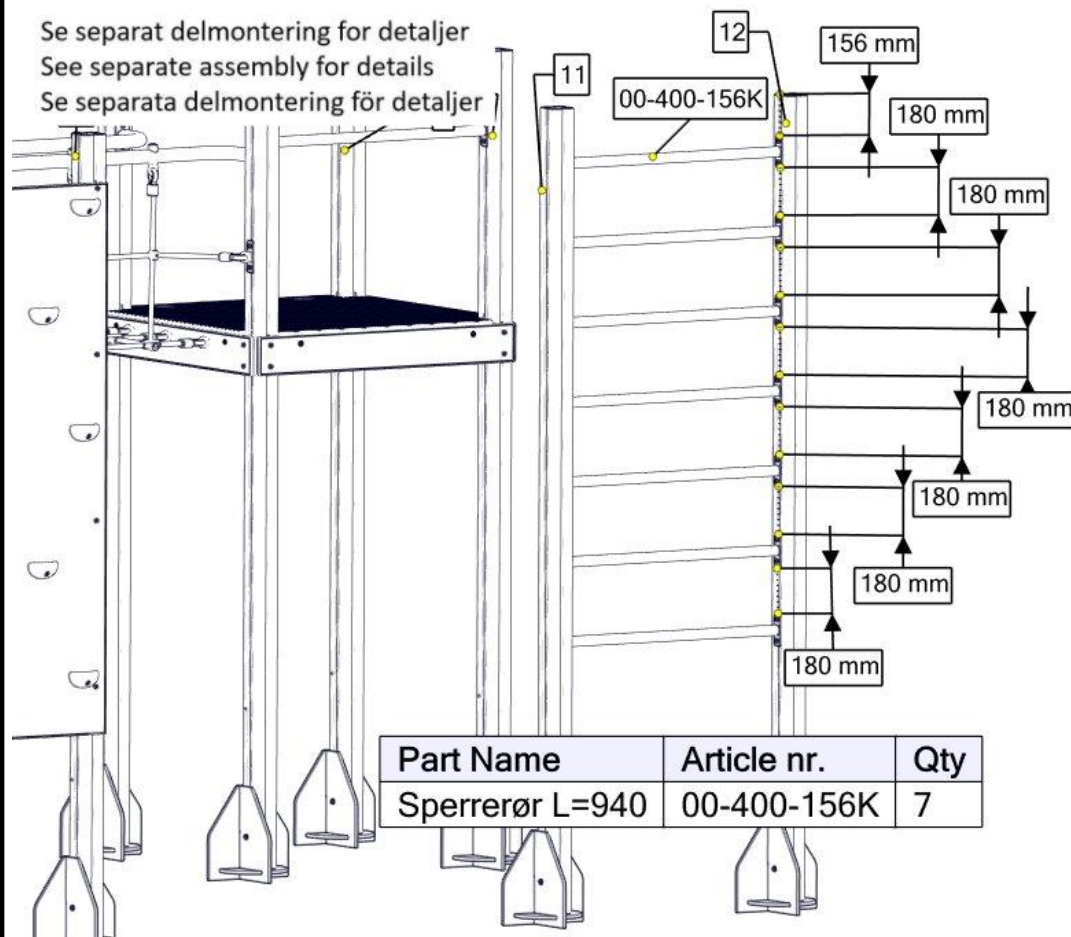

Part Name	Article nr.	Qty
Sperrerør L=940	00-400-156K	7

### Montering av lekeapparatet / Assembly instructions / Montering av lekredskapet

Se separat delmontering for detaljer  
 See separate assembly for details  
 Se separata delmontering för detaljer

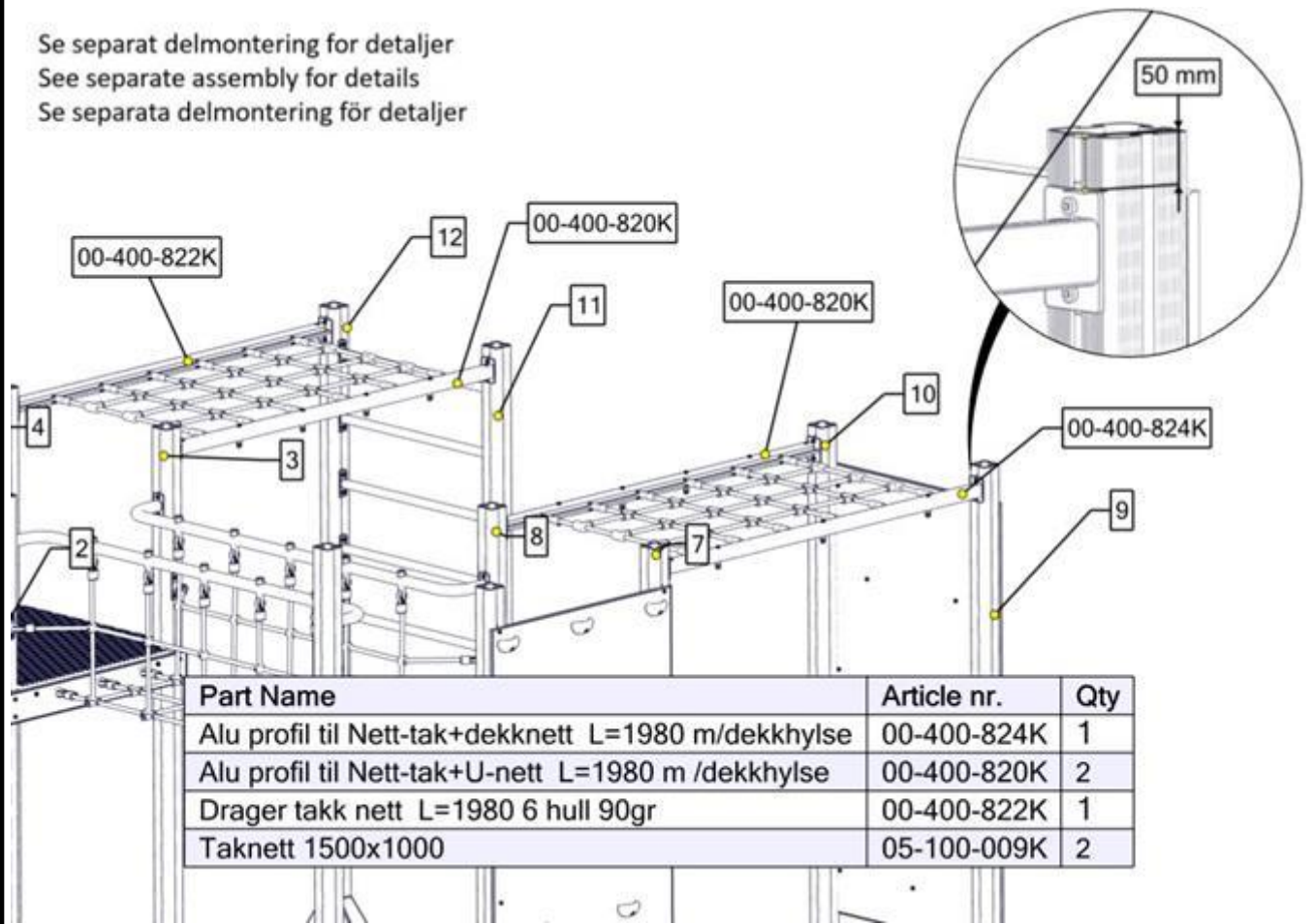

Part Name	Article nr.	Qty
Alu profil til Nett-tak+dekknett L=1980 m/dekkhylse	00-400-824K	1
Alu profil til Nett-tak+U-nett L=1980 m /dekkhylse	00-400-820K	2
Drager takk nett L=1980 6 hull 90gr	00-400-822K	1
Taknett 1500x1000	05-100-009K	2

Se separat delmontering for detaljer  
 See separate assembly for details  
 Se separata delmontering för detaljer

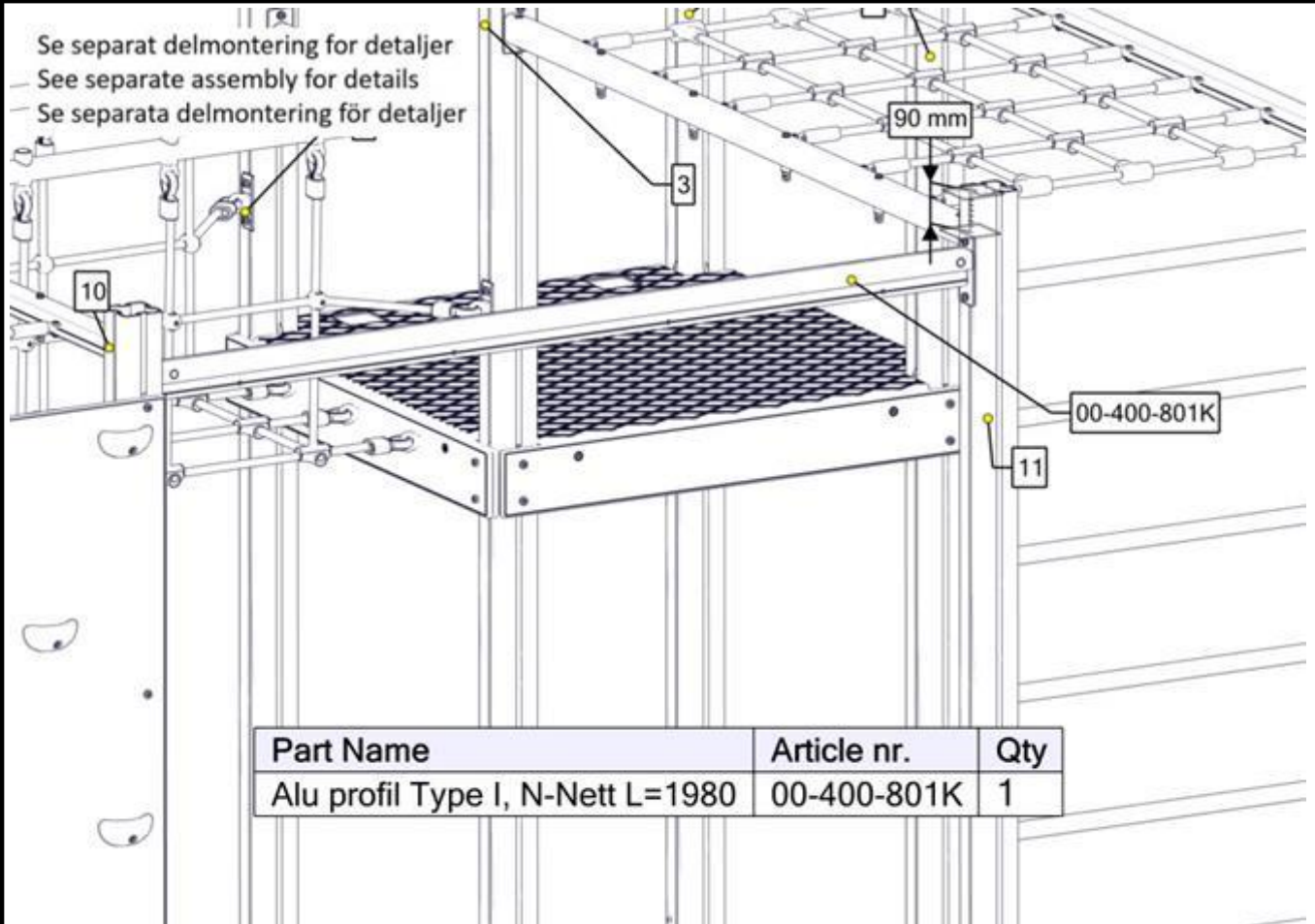

Part Name	Article nr.	Qty
Alu profil Type I, N-Nett L=1980	00-400-801K	1



**Montering av lekeapparatet / Assembly instructions / Montering av lekredskapet**

Se separat delmontering for detaljer  
 See separate assembly for details  
 Se separata delmontering för detaljer

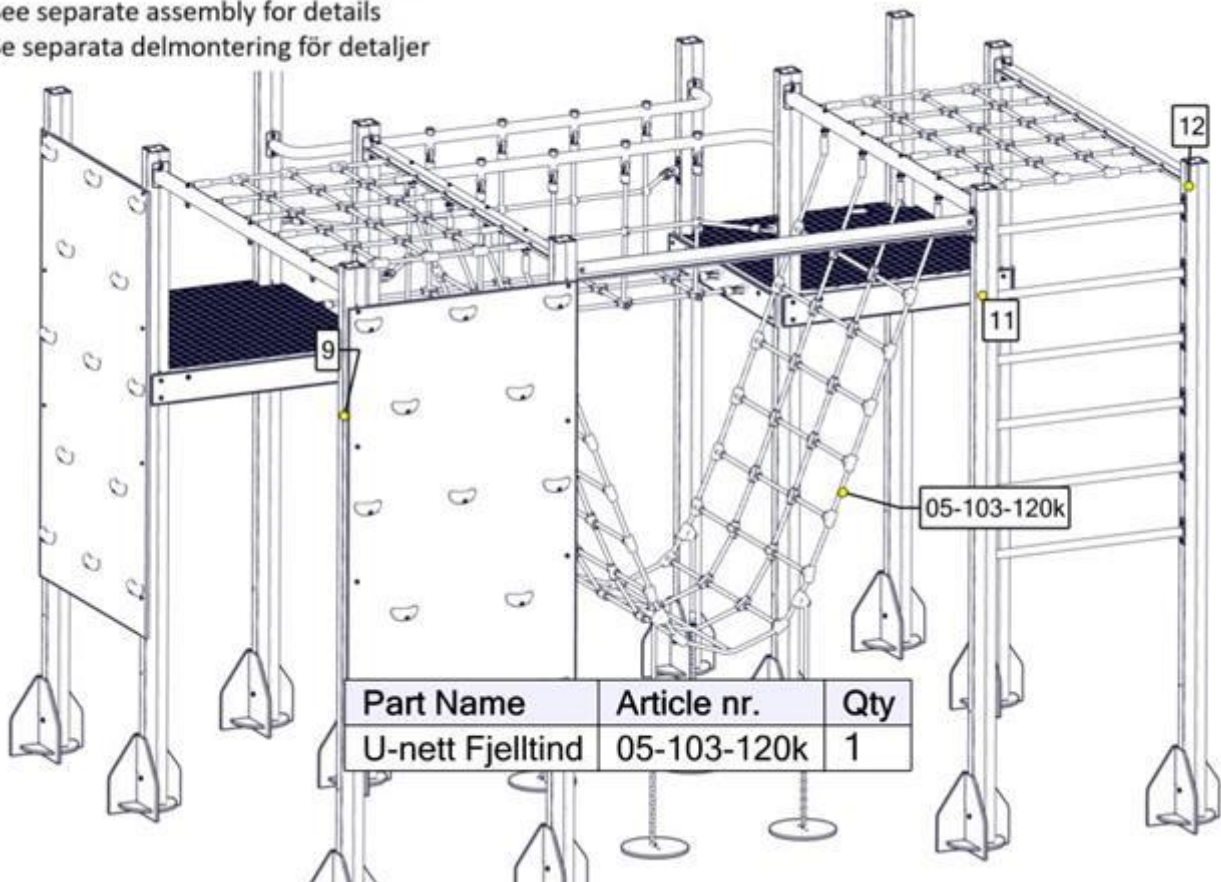

Part Name	Article nr.	Qty
U-nett Fjelltind	05-103-120k	1

Se separat delmontering for detaljer  
 See separate assembly for details  
 Se separata delmontering för detaljer

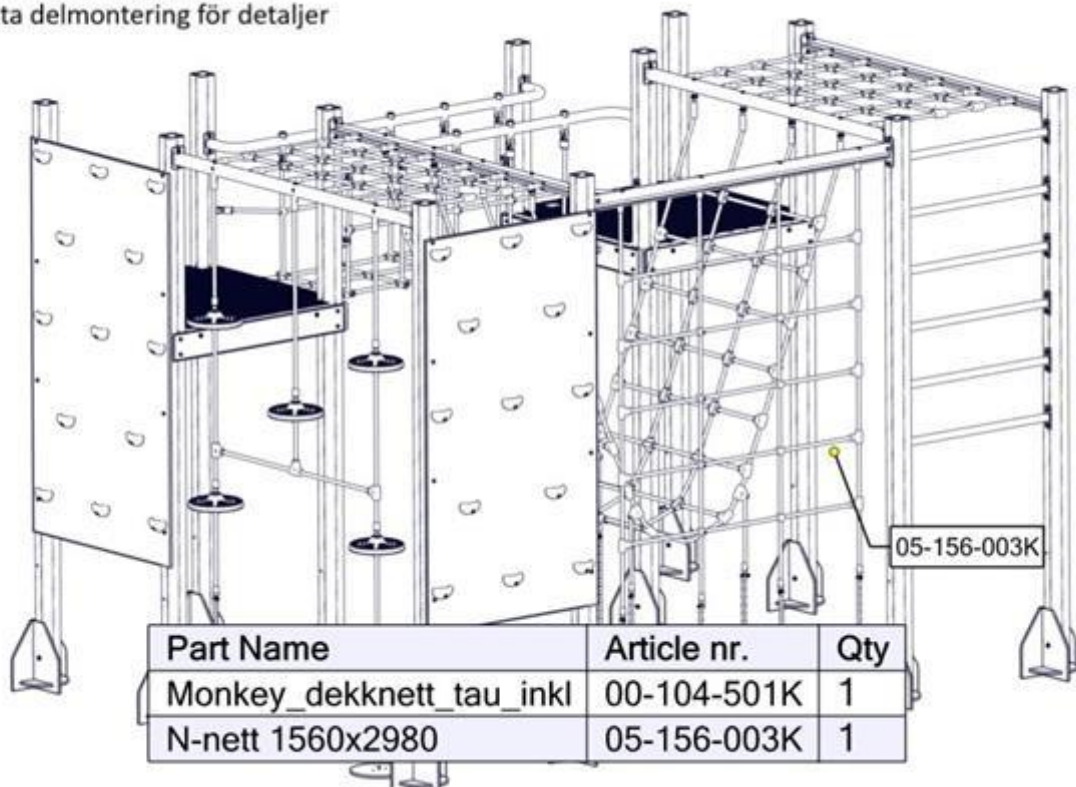

Part Name	Article nr.	Qty
Monkey_dekknett_tau_inkl	00-104-501K	1
N-nett 1560x2980	05-156-003K	1

## Montering av lekeapparatet / Assembly instructions / Montering av lekredskapet

Se separat delmontering for detaljer  
 See separate assembly for details  
 Se separata delmontering för detaljer

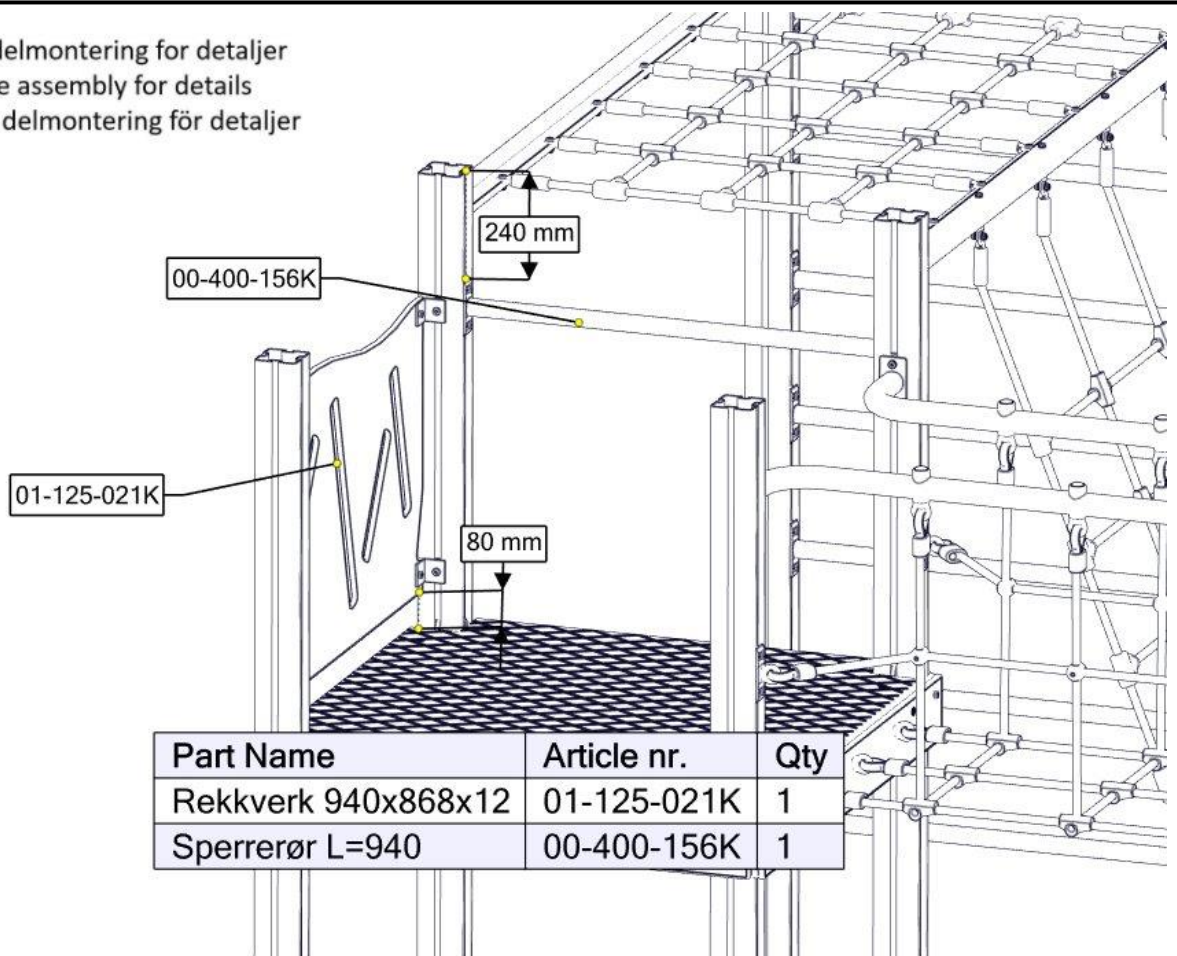

Se separat delmontering for detaljer  
 See separate assembly for details  
 Se separata delmontering för detaljer

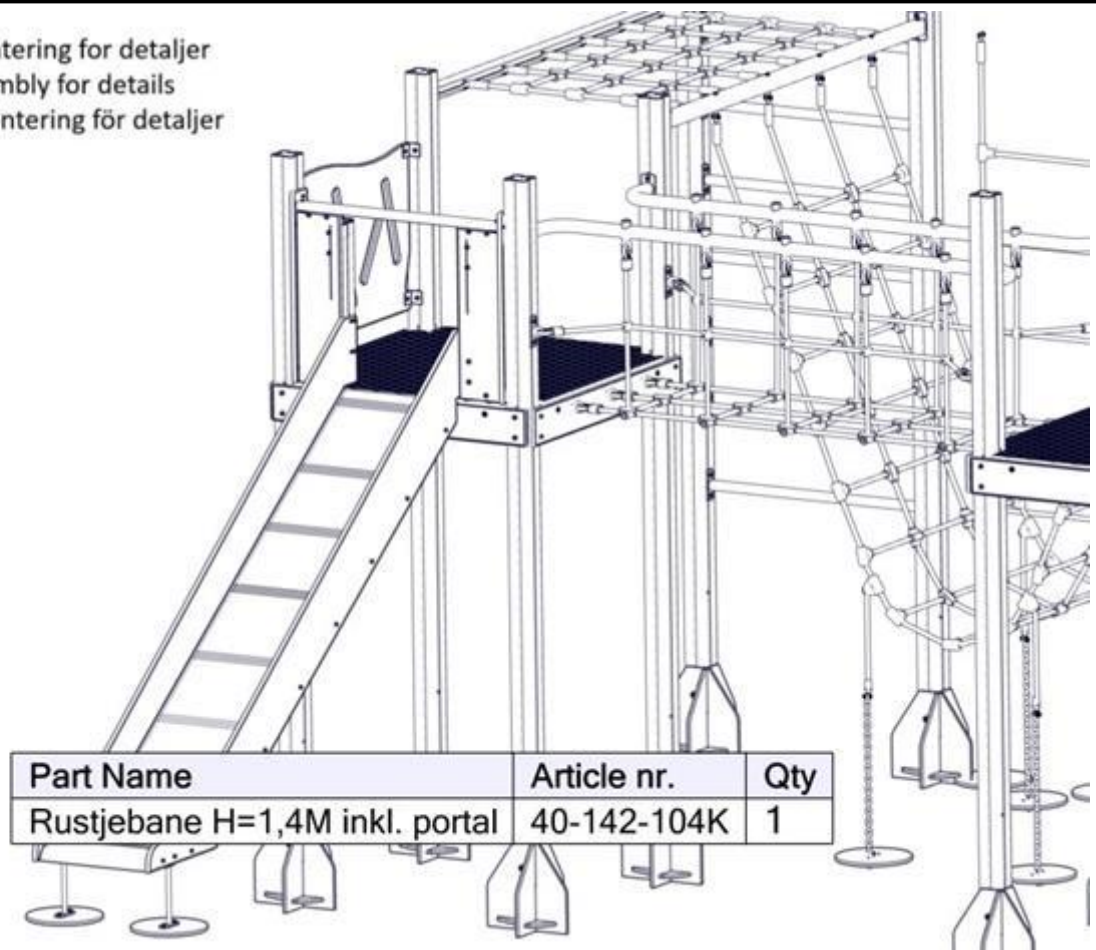



## Montering av lekeapparatet / Assembly instructions / Montering av lekredskapet

Se separat delmontering for detaljer  
See separate assembly for details  
Se separata delmontering för detaljer

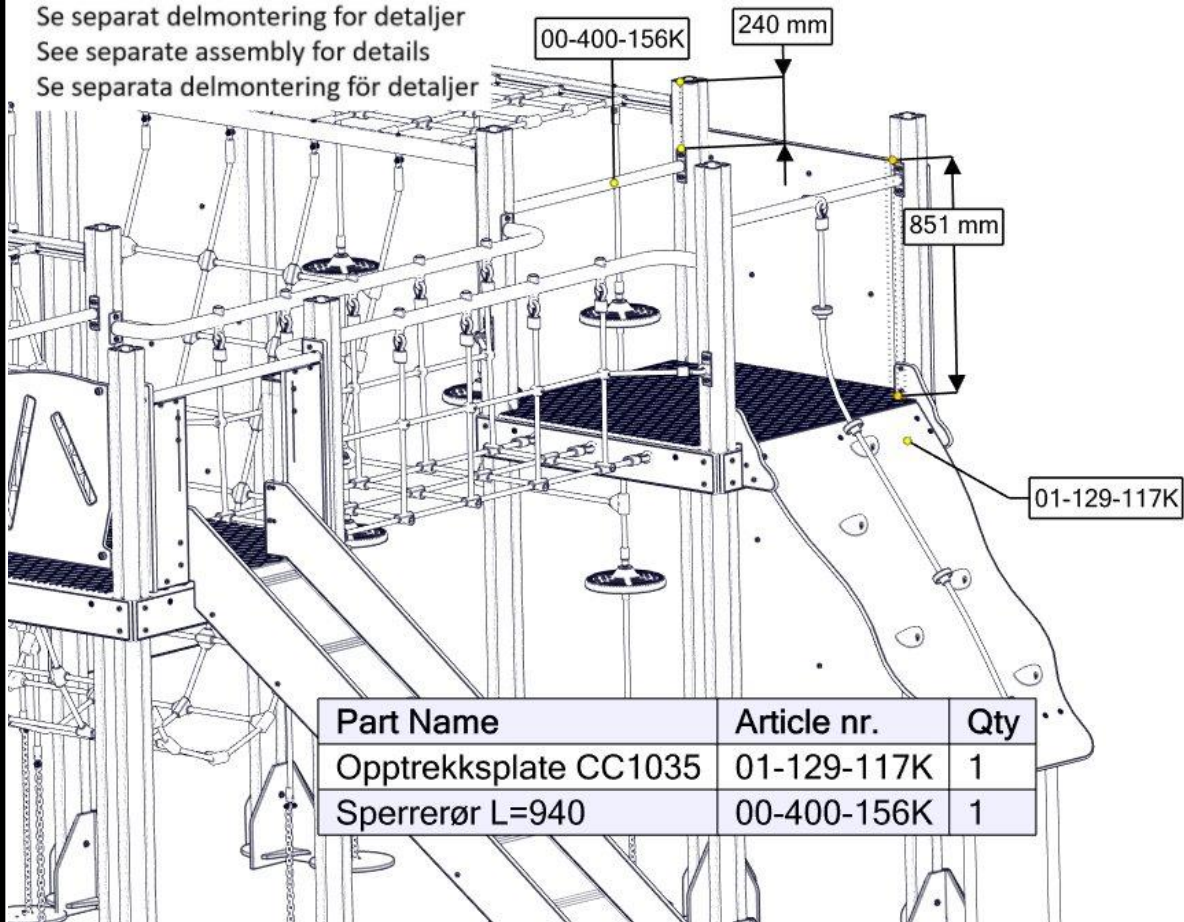

Part Name	Article nr.	Qty
Opptreksplate CC1035	01-129-117K	1
Sperrerør L=940	00-400-156K	1

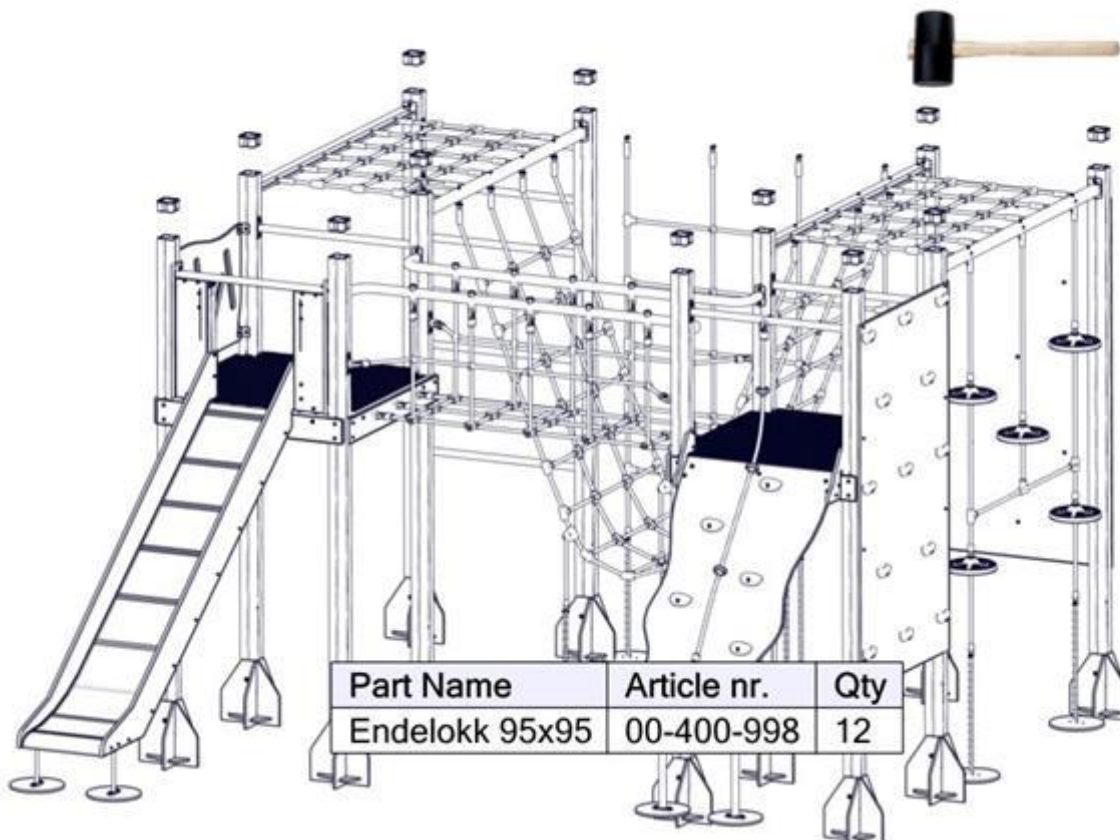









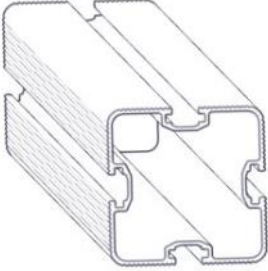

Part Name	Article nr.	Qty
Endelokk 95x95	00-400-998	12

<b>Før utstyret tas i bruk / Before play begins / Innan lekredskapet tas i bruk</b>	
<b>N</b>	<ul style="list-style-type: none"> <li>● Påse at fallunderlag er utlagt i henhold til gjeldende regler eller vår anbefaling</li> <li>● Fjern alle monteringshjelpemidler ( rester av betong, planker, paller, plast, og lignende)</li> <li>● Før utstyret tas i bruk, burde man sjekke at det ikke er fare for at anorakksnorer og lignende som kan hekte seg fast noen steder på lekeapparatet. (Vedlagte snor med dobbe (kneledd) kan brukes til å sjekke at dette er i orden. Se vedlagte veiledning for bruk av denne. Dette gjøres for å oppdage eventuelle feilmonteringer.?)</li> <li>● NB! Bør stå i 2-3 dager før bruk</li> </ul>
<b>EN</b>	<ul style="list-style-type: none"> <li>● Make sure the area and depth of safer surfacing are according to the current standard, or to the manufacturer's recommendation</li> <li>● Make sure all tools and surplus materials are removed before play begins</li> <li>● PS! When complete, allow 2-3 days for the concrete to set before use</li> </ul>
<b>S</b>	<ul style="list-style-type: none"> <li>● Kontrollera att fallunderlag är utlagt enligt gällande regler eller vårt rekommendation</li> <li>● Ta bort alla monteringshjälpmedel (rester av betong, plankor, pallar, plast och liknande)</li> <li>● Innan lekredskapet används, kontrollera att anoracksnoddar eller kläder/delar av kläder eller liknande inte kan fastna i några delar på redskapet. (Den bipackade "knävringen" kan man med fördel användas för denna kontroll.</li> <li>● Detta görs för att upptäcka eventuella felmonteringar.)</li> </ul>



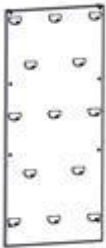



**Boltepakker for / Boltpackage for / Bultpaket för**

Sign. \_\_\_\_\_

Fjelltind 30-802-020	Navn	Artnr/ dimensjon	Ant	Lev
	Stolpe 95x95 600-2430 Lengde = 3030 Sort  Stolpe 95x95 600-2300 Lengde = 2900 Sort	SFA5117/1   SFA5117/1	10   2	
	Endelokk 95x95 Sort	00-400-998	12	
	Gulv P-0-0-0 1160x1160x15 Grå	00-400-299K (se egen delmontering)	1	
	Gulv for klatrevegg 1160x1160x15 Grå	00-400-356K (se egen delmontering)	1	
	Sprosse standard 1130x145x15 Grå	00-400-104K (se egen delmontering)	6	
	Sprosse dobbel 3 hull cc265 1130x145x15 Grå	01-400-123K (Se egen delmontering)	2	



<b>Boltepakker for / Boltpackage for / Bultpaket för</b>		Sign. _____		
<b>Fjelltind 30-802-020</b>	<b>Navn</b>	<b>Artnr/ dimensjon</b>	<b>Ant</b>	<b>Lev</b>
	Sperrerør 940x120 Sort	00-400-156K (Se egen delmontering)	9	
	Klatrevegg Trestuktur	00-400-718K (se egen delmontering)	2	
	Brua Sort	07-500-047K (se egen delmontering)	1	
	Taknett 1500x1000 Sort	05-100-009K (se egen delmontering)	2	
	Alu profil til Nett-tak + U-nett L=1980 Sort m/ dekkhylse montert	00-400-820K (se egen delmontering)	2	
	Alu profil til Nett-tak + dekknett L=1980 Sort m/ dekkhylse montert	00-400-824K (se egen delmontering)	1	



<b>Boltepakker for / Boltpackage for / Bultpaket för</b>		Sign. _____		
<b>Fjelltind 30-802-020</b>	<b>Navn</b>	<b>Artnr/ dimensjon</b>	<b>Ant</b>	<b>Lev</b>
	Drager tak nett 6 hull L=1980 Sort m/ dekkhylse montert	00-400-822K (se egen delmontering)	1	
	Alu profil Type I, N-nett L=1980 Sort	00-400-801K (se egen delmontering)	1	
	U-nett Fjelltind Sort	05-103-120K (se egen delmontering)	1	
	Monkey dekknett 5 stk	00-104-501K (se egen delmontering)	1	
	N-nett 1560x2980 Sort	05-156-003K (se egen delmontering)	1	
	Produktmerke	00-100-400 (montert hos Søve)	0	

**Boltepakker for / Boltpackage for / Bultpaket för**

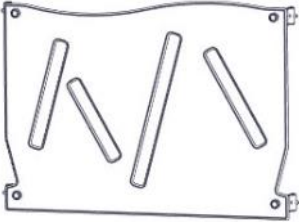
Sign. \_\_\_\_\_.

Fjelltind 30-802-020	Navn	Artnr/ dimensjon	Ant	Lev
	Rekkverk 940x686 Trestruktur	01-125-021K (se egen delmontering)	1	
	Rutsjebane med protal H=1,4m Grå/Trestruktur	40-142-104K (se egen delmontering)	1	
	Opptreksplate cc1035 Grå	01-129-117K (se egen delmontering)	1	

# Fundamentering/foundation

Sign. \_\_\_\_\_

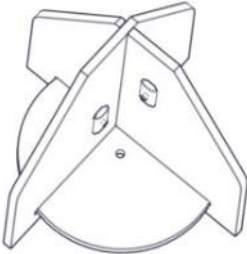
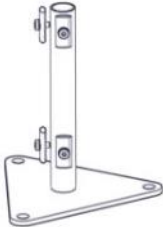
Fjelltind 30-802-020	Navn	Artnr/ dimensjon	Ant	Lev
	<b>Støp/concret</b>			
	Støpefundament 95 x 95 stolpe	00-003-110K (se egen delmontering)	12	
	<b>Nedgravning</b>			
	Nedgravningsfundament 95 x 95 stolpe	00-003-004K (se egen delmontering)	12	
	<b>Overflatemontering</b>			
	Fundament 95x95 stolpe for betongdekke	00-003-125K (se egen delmontering)	12	
	Changed parts Foundations 40-142-104K  01-129-117K  Stolpe må kappes		2  2  12	

28.05.2021 SV

Lagt til et sperrerør i et view som var glemt og justert div andre views. (plukklister var riktige)