



Monteringsanvisning



Assembly Instructions



Monteringsanvisning

Produkt nr. / Product no. / Produkt nr.

30-850-110

Sort

Ord. nr. _____

Dato. _____

Sign. _____

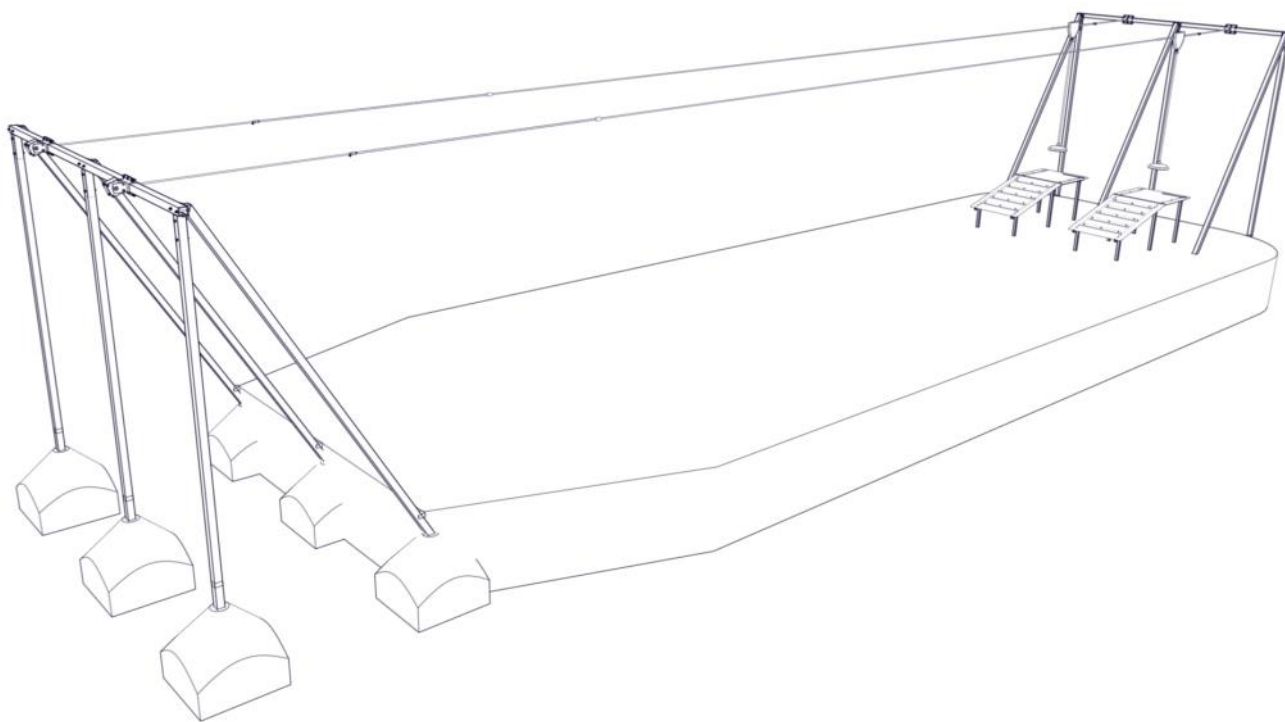

Søve AS
Grønnvoldveien 290
3830 Ulefoss - Norway
Tlf: +47 35 94 65 65
www.sove.no



Søve AB
EA Rosengrensgatan 32
421 31 Västra Frölunda
Phone: +46 (0)31 773 97 00
www.sove.se

Monteringstips / Assembly Advice / Monteringsstips

N

- Les monteringsanvisningen nøye før montering.
- Monter elementene i rekkefølgen som vist.
- Boltene bør ikke skrues for hardt til før alt er montert, vatret og loddet. Skru så boltene til.
- NB! Ved bruk av drill, kan boltene ryke.
- På grunn av at solen kan gjøre rutsjeflaten veldig varm, bør rutsjebanens utløp vende mot nord-øst eller nord-vest.
- Er lekeutstyret plassert i naturlige ferdselstraséer må området sikres mot gjennomgang.
- Innspringningshinder bør vurderes rundt lekeapparater hvor det er stor bevegelse, f.eks. ved huskestativ.
- Det bør være fritt innsyn til lekeutstyr som er beregnet for barn under 3 år.

NB! Under monteringsarbeidet må utstyr, som ikke er forankret forsvarlig i bakken, sikres slik at det ikke velte.

Området må avstenges under montering av apparatene med sperrebånd eller lignende.

EN

- Read the instruction carefully before assembling the play unit.
- Assemble the components in the sequence shown in these instructions. Fixings must not be fully tightened during assembly. Before casting the foundations, the structure must be level and plumb, at which point all fixings are tightened. PS! If use of drill, the bolts may be wrecked.
- Avoid positioning the slide facing due south because of overheating – ideal positions are facing north-east or north-west. Secure the construction-area to prevent people from walking through it.
- Consider installing barriers around play-equipment which gives rise to a lot of activity – i.e. swings.
- Ensure that clear vision is possible across the play area so that supervision is possible from any position, particularly where children under 3 years of age will be playing.

NB! During assembly of the equipment, ensure that all structures are securely propped, especially when left overnight. Also ensure that equipment is supported

Monteringstips / Assembly Advice / Monteringsstips**S**

- Läs monteringsanvisningen noga före montering.

- Montera delarna i den ordningen som anvisas
- Skruvarna bör inte skruvas för hårt tills allt är monterat, i våg och lodat.











OBS! Används elektrisk skruvdragare, kan bulten gå sönder. Hårdra därför manuellt!

- Solen kan göra att rutchbanan blir väldigt varm. Banans nedfart rekommenderas att vändas i norrlig riktning
- Om lekplatsen placeras vid en gångväg mm bör området säkras mot genomfart av gående och cyklister.
- Insprängningshinder bör placeras runt lekutrustning med stor rörelse, t ex, gungställning.
- Det bör vara fri insyn till lekutrustning beräknat till barn under 3 år.

OBS! Under monteringsarbete bör utrustningen som inte ska förankras i marken, ställs så att den inte kan välta.

Området måste spärras när lekutrustningen byggs upp, med avspärrningsband eller liknande.

Nødvendig verktøy / Tools required / Nödvändiga verktyg

<p>(N)</p> <p>(EN)</p> <p>(S)</p>	<p>(A)</p> 	<p>(B)</p>  <p>Torx Nr 45</p>	<p>(C)</p> <p>5 mm 6 mm</p> 	<p>(D)</p> 	<p>(E)</p> 
		<p>Metermål</p> <p>Metric measure</p> <p>Tumstock</p> 	<p>Ø11mm Bor</p> <p>Ø11mm Drill</p> <p>Ø11mm Borr</p> 	<p>Merkebånd</p> <p>Mark ribbon</p> <p>Märkeband</p> 	<p>13 + 17mm</p> 

Nødvendig antall personer / Number of persons required / Rekommenderad antal personer

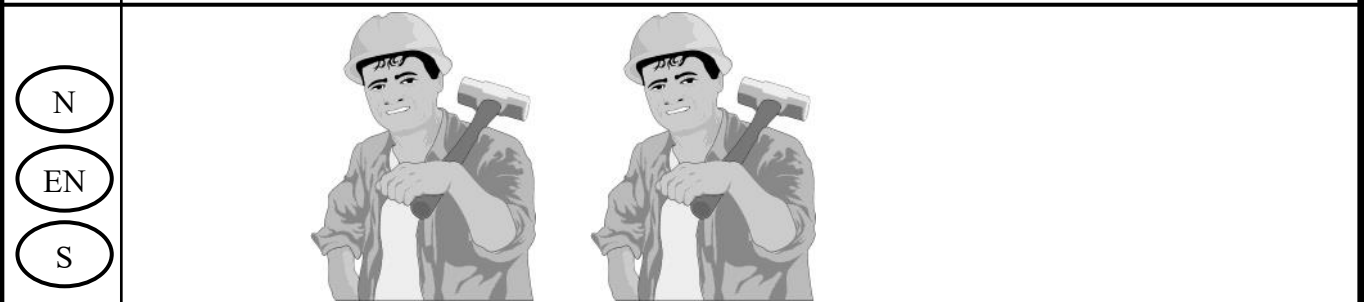



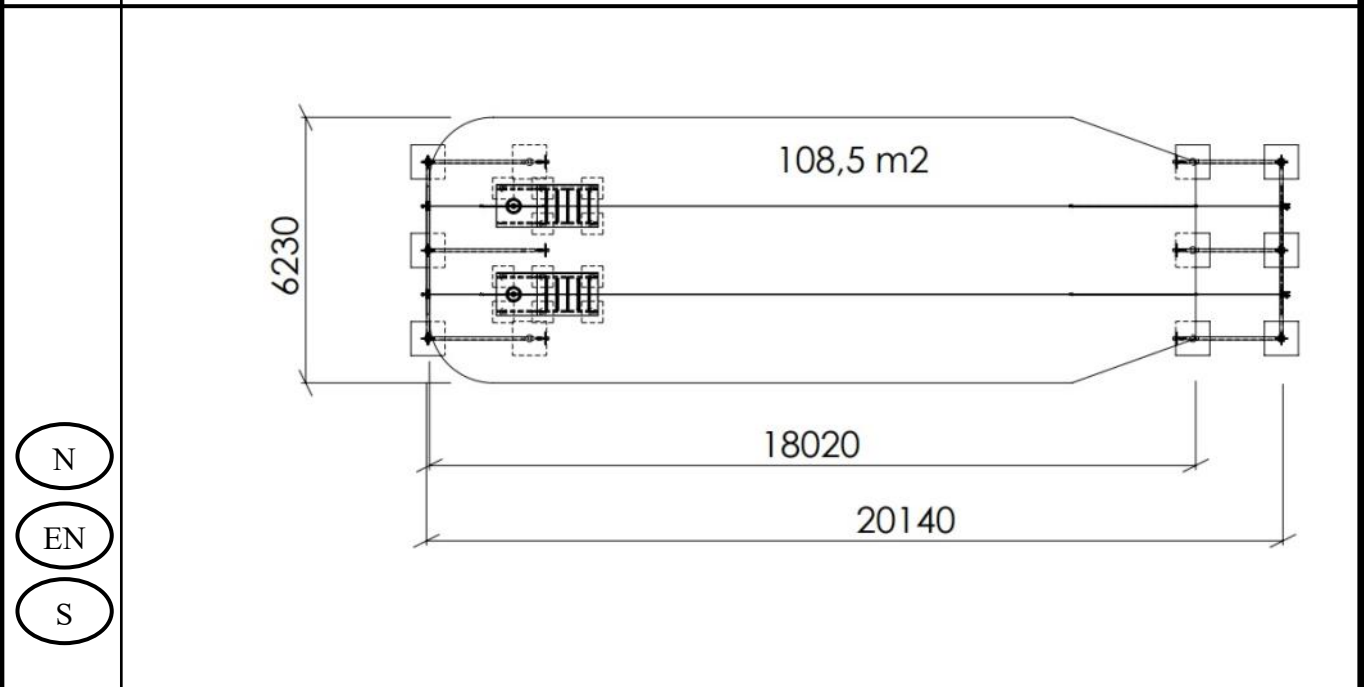



Anbefalt arealbehov ved montering / Recommended working space / Rekommenderad arealbehov vid montering









Boltepakker for / Boltpackage for / Bultpaket för



Sign. _____.

Taubane dobbel 30-850-110	Navn	Artnr/ dimensjon	Ant	Lev
	Taubane, overligger 4200x70 Sort	00-850-023	2	
	Taubane, rett bein lang 4700x70 Sort	00-850-011	3	
	Taubane, rett bein kort 4200x70 Sort	00-850-012	3	
	Taubane, skrå bein lang 5500x70 Sort	00-850-013	3	
	Taubane, skrå bein kort 4920x70 Sort	00-850-014	3	
	Taubane, bein rampe skrå midt 1350 Sort	00-850-015	4	

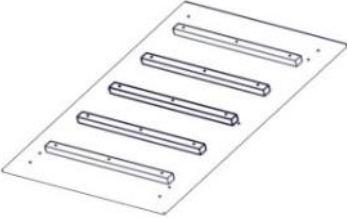

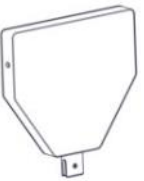
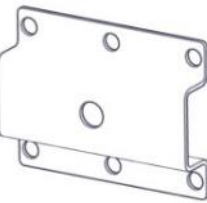
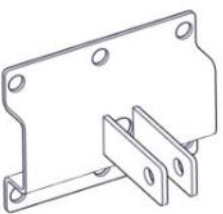

Boltepakker for / Boltpackage for / Bultpaket för

Sign. _____

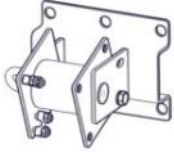
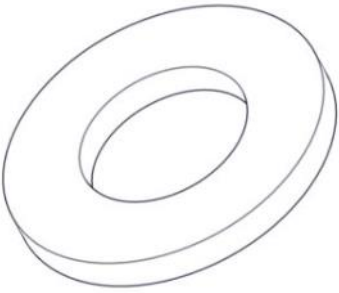
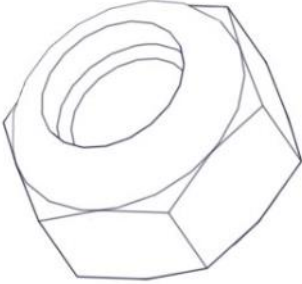
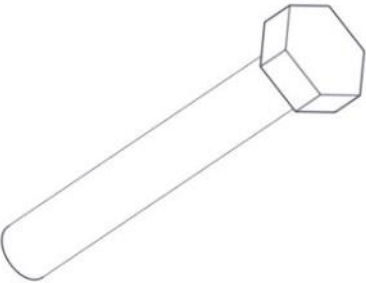
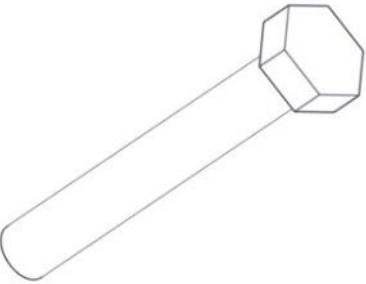
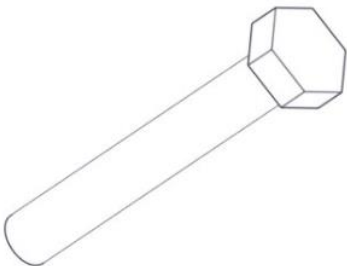
Taubane dobbel 30-850-110	Navn	Artnr/ dimensjon	Ant	Lev
	Taubane, bein rampe skrå lav ende L=993x40 Sort	00-850-016	4	
	Taubane, bein rampe rett høy ende L=1380x40 Sort	00-850-017	4	
	Taubane, rampe underligger L=2396x40 Sort	00-850-018	4	
	Taubane, rampe HPL rett del 1000x960x15 Brun	00-850-019	2	
	Taubane, rampe HPL skrå montert trinn 1500x1000x15 Brun	00-850-020	2	
	Taubane, wire 21meter	00-850-031	2	

Boltepakker for / Boltpackage for / Bultpaket för		Sign. _____.		
Taubane dobbel 30-850-110	Navn	Artnr/ dimensjon	Ant	Lev
	Taubane, bremsewire med fjær 1,5meter	00-850-032	2	
	Taubane, bremsewire med fjær 3meter	00-850-033	2	
	Taubane, sete med plastkjetting Sort	00-850-035	2	
	Taubane, løpekatt komplett	00-850-036	2	
	Taubane, endebeslag For 00-850-038 og 00-850-039	00-850-038/039	4	
	Taubane, brakett for innfesting av wire	00-850-038	2	

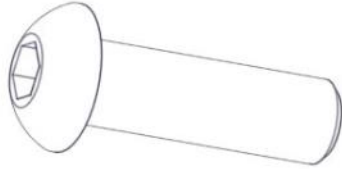
Boltepakker for / Boltpackage for / Bultpaket för		Sign. _____		
Taubane dobbel 30-850-110	Navn	Artnr/ dimensjon	Ant	Lev
	Taubane, vaierstrammer	00-850-039	2	
	Skive M8	04-050-008	40	
	Skive M10	04-050-010	98	
	Skive M12	04-050-012	52	
	Låsemutter M8	04-040-008	2	
	Låsemutter M10	04-040-010	26	
	Låsemutter M12	04-040-012	26	
	Sekskant M8x50	04-008-050	12	
	Sekskant M8x55	04-008-055	24	
	Sekskant M10x90	04-010-090	12	
	Sekskant M10x100	04-010-100	12	
	Sekskant M12x30	04-012-030	24	
	Sekskant M12x55	04-012-055	2	

Boltepakker for / Boltpackage for / Bultpaket för		Sign. _____.		
Taubane dobbel 30-850-110	Navn	Artnr/ dimensjon	Ant	Lev
	Torx M8x35	04-000-035	2	
	Møbelknapp M8x25	04-030-025	36	
	Unbrako skrue linsehodet M10x30	04-036-030	2	
	Produktmerke	00-100-400 (montert hos Søve)	0	

Boltepakker for / Boltpackage for / Bultpaket för

Sign. _____.

Taubane dobbel 30-850-110	Navn	Artnr/ dimensjon	Ant	Lev
	Fundament støp			
	Armering L=300	03-191-013	24	

Fundamentering med betong / Foundation concrete / Förankring med betong

- (N) Støtdempende materialer
- (EN) Impact attenuating materials
- (S) Støtdämpande material

Ref
NS-EN 1176-1
§4.2.8.5



- (N) Bakkenivå
- (EN) Ground level
- (S) Marknivå

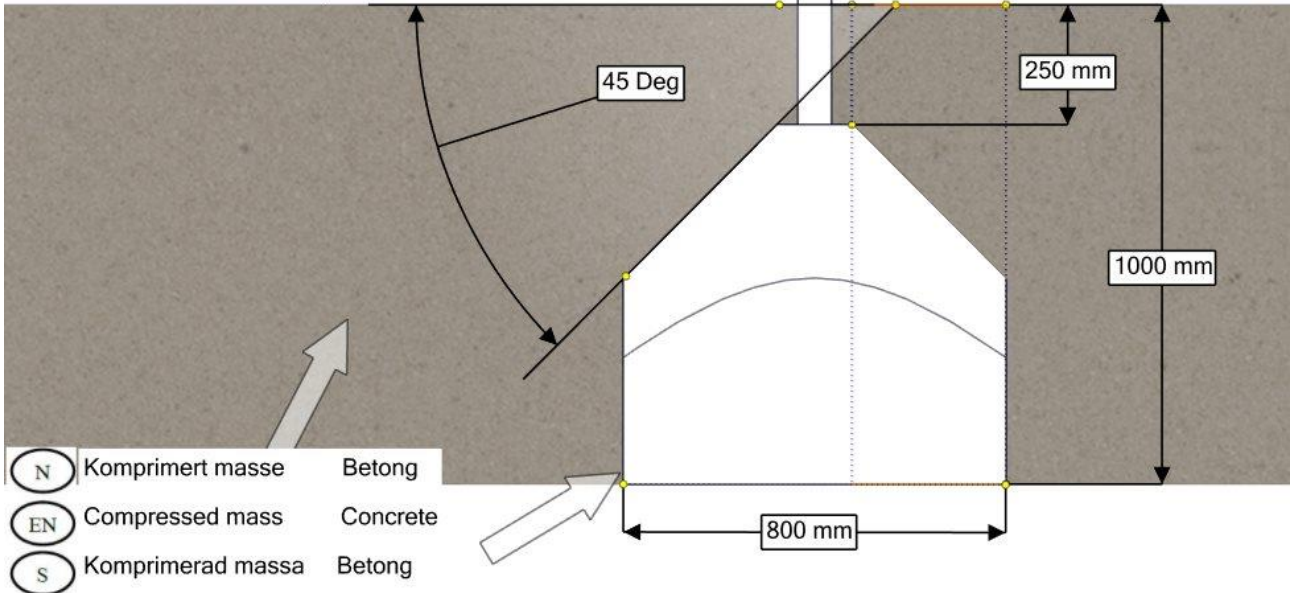

- (N) Støtdempende materialer
- (EN) Impact attenuating materials
- (S) Støtdämpande material

Ref
NS-EN 1176-1
§4.2.8.5



- (N) Bakkenivå
- (EN) Ground level
- (S) Marknivå

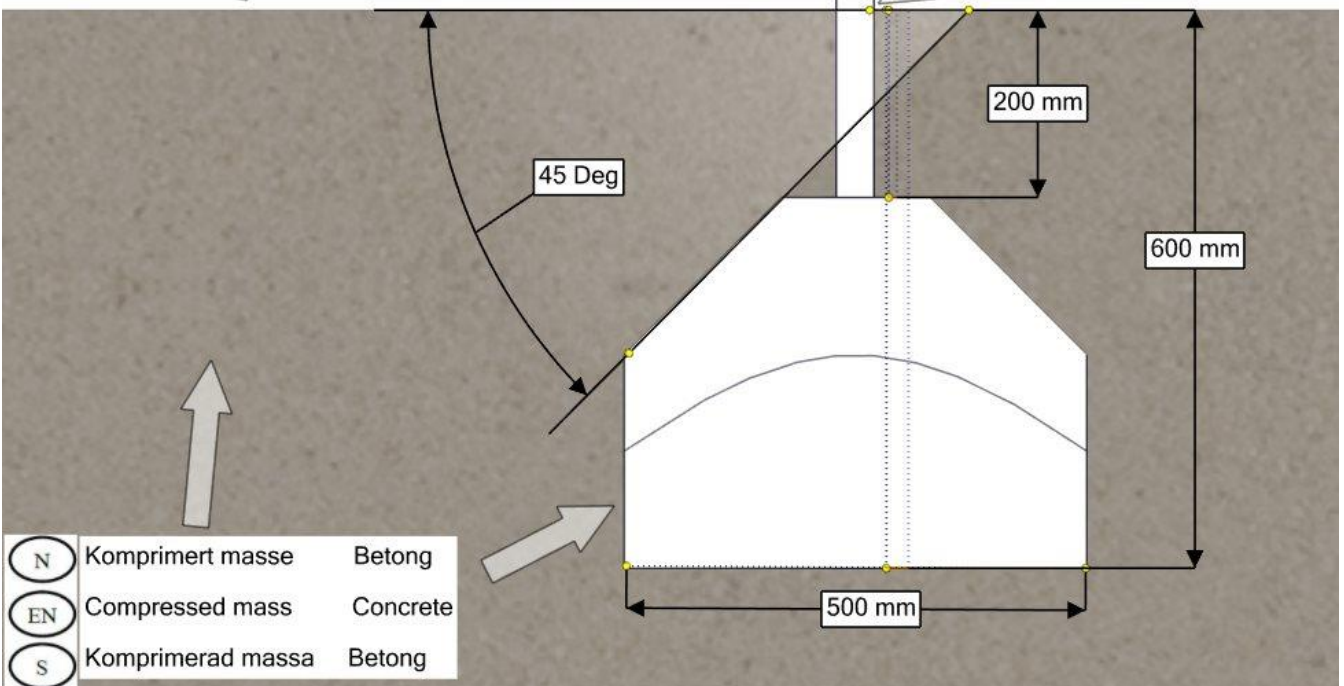

NO	Betongkvalitet	C25/30		
SE	Betongkvalitet			
EN	Concrete quality			
NO	Mengde betong		4,4	m ³
SE	Mängd betong			
EN	Amount of concrete			
NO	Fundament størrelse		0,5 x 0,5 x 0,8 0,5x0,5x0,4	m
SE	Stiftelsestorlek			
EN	Foundation size			
NO	For sikkerhet må fundamentene med sand eller myk jord være minst 50% større i areal			
SE	För säkerheten måste grunden med sand eller mjuk jord vara minst 50% större i området			
EN	For safety, the foundations with sand or soft soil must be at least 50% larger in area			
NO	Tyngste element	00-850-020	36	Kg
SE	Tyngsta element			
EN	Heaviest element			
NO	Største element	00-850-020 00-850-013	1,5x1x0,015 5,5x0,07x0,07	m
SE	Största element			
EN	Biggest element			

Sikkerhetssone / Safety zone / Säkerhetszon

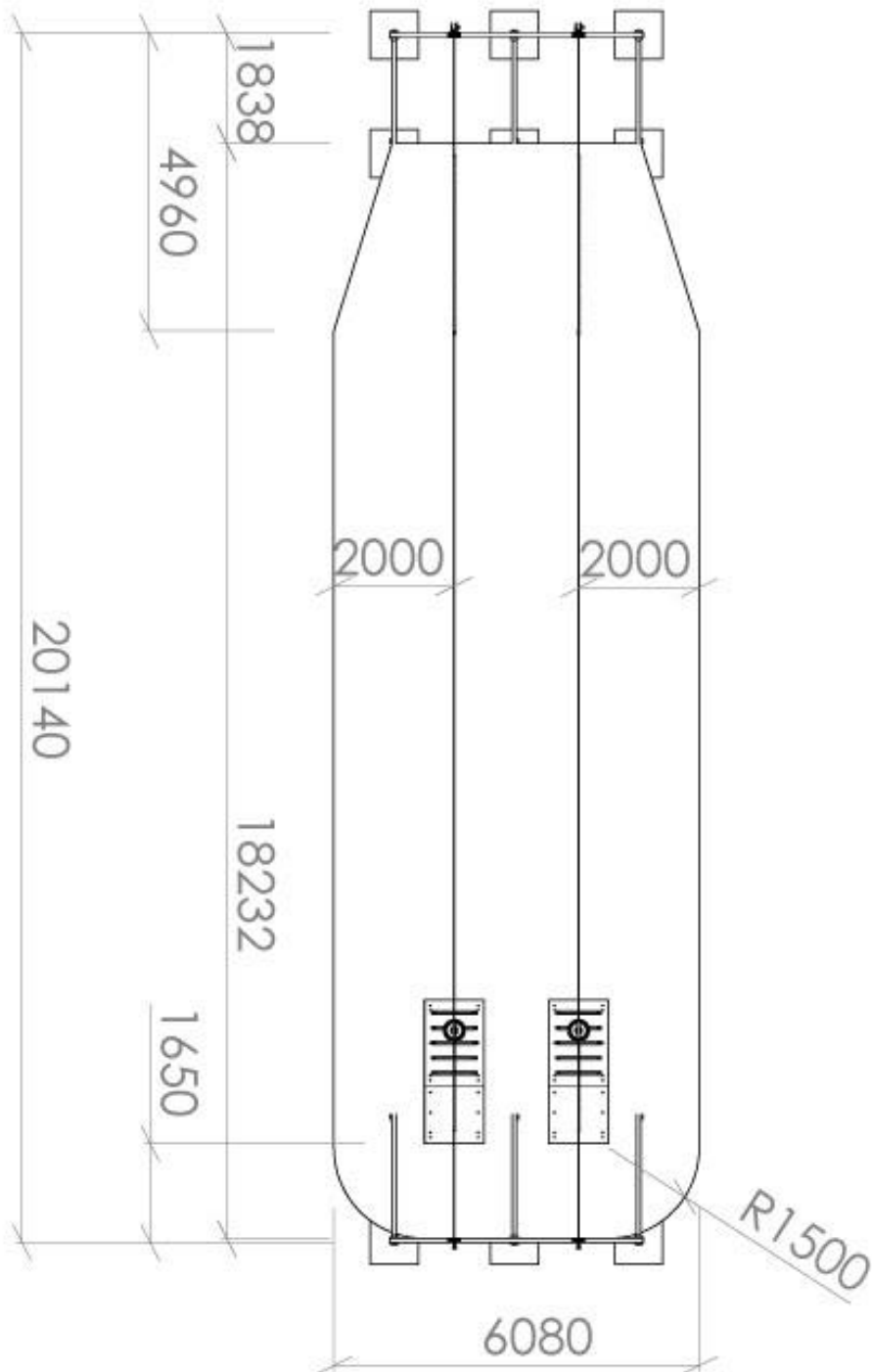

Plassering av forankringer / Ground plan / Placering av förankringar

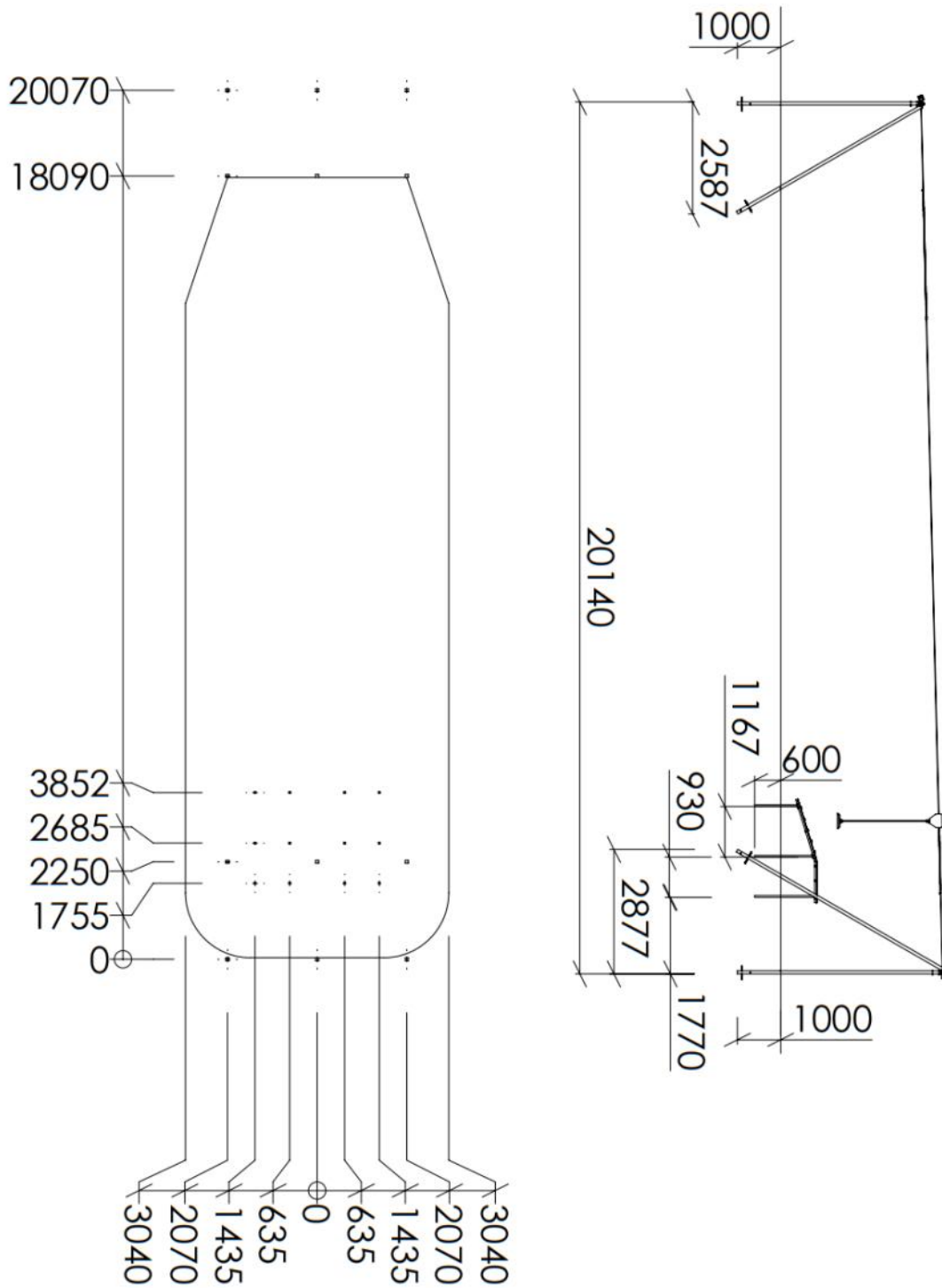

N

Alle mål er oppgitt i millimeter

EN

Scale measured in mm

S

Alla mått är i millimeter.

Montering av lekeapparatet / Assembly instructions / Montering av lekredskapet

Fallhøyde < 1 meter

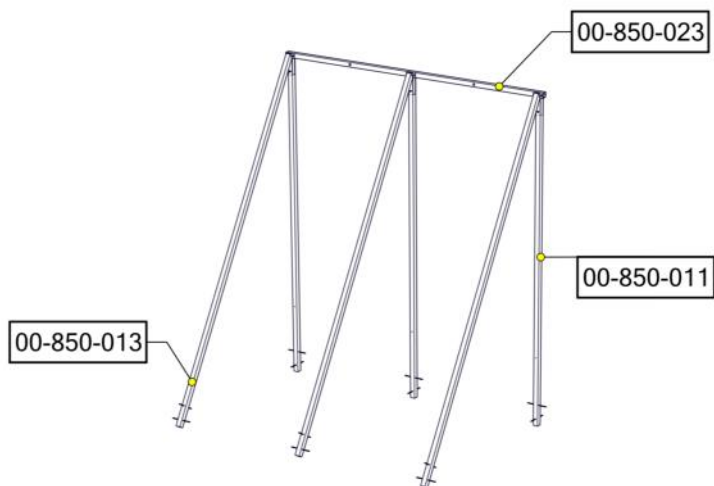
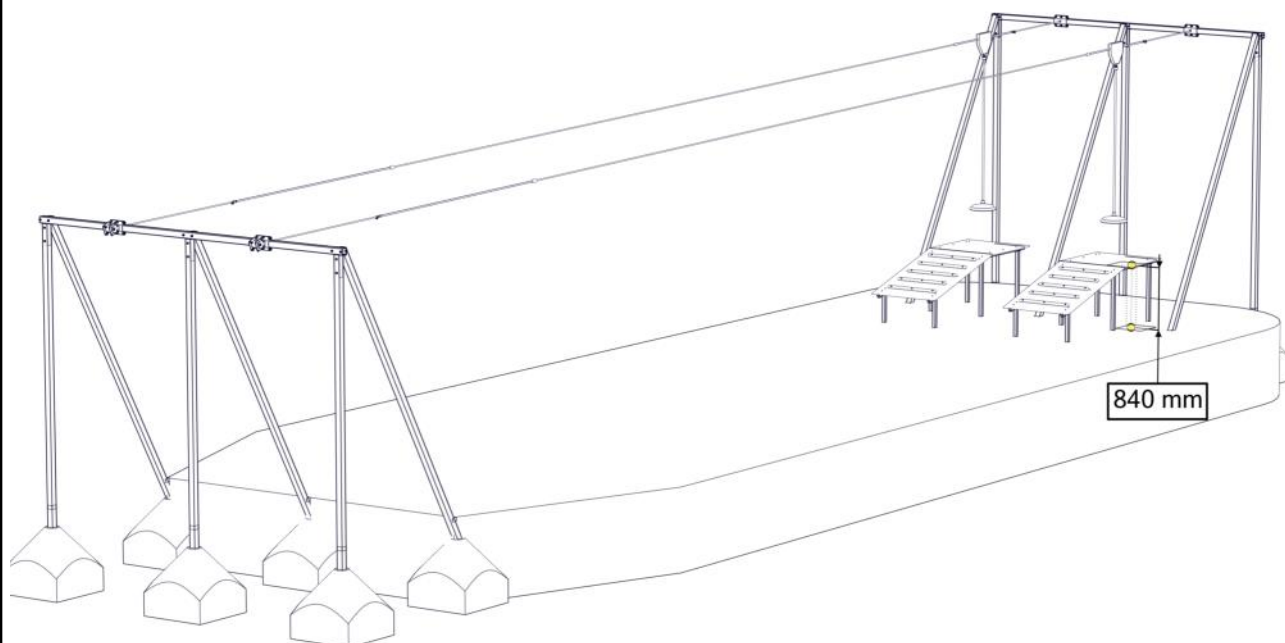

PartName	Artnr	Antall
Taubane_langBein_rett L=4400	00-850-011	3
Taubane_Bein_skrå L=5140	00-850-013	3
TauBane_overligger L=4220	00-850-023	1
Armering	03-191-013	12
Sekskant skrue M10x90	04-010-090	6

PartName	Artnr	Antall
Sekskant skrue M10x100	04-010-100	6
Låsemutter M10	04-040-010	12
Skive M10	04-050-010	48

Montering av lekeapparatet / Assembly instructions / Montering av lekredskapet

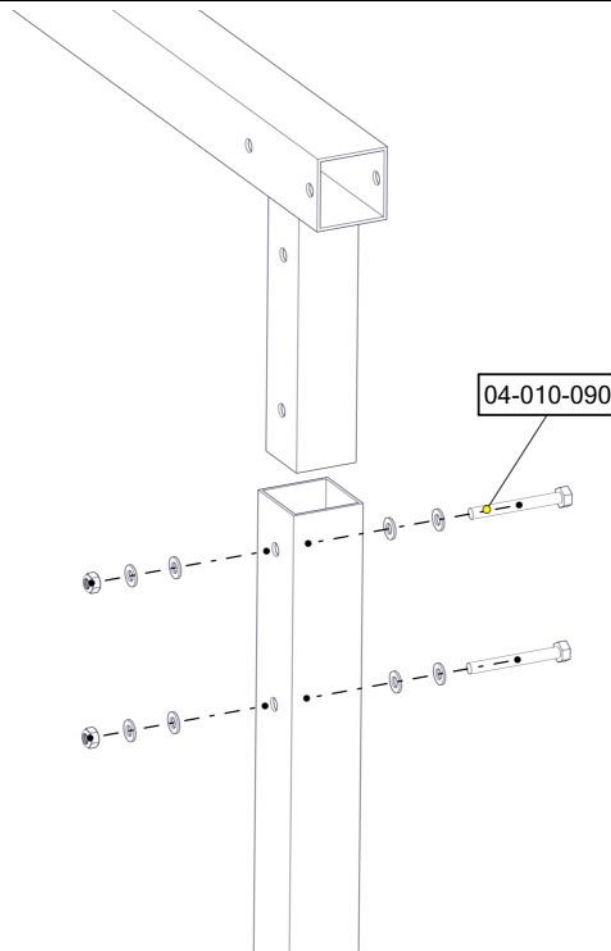
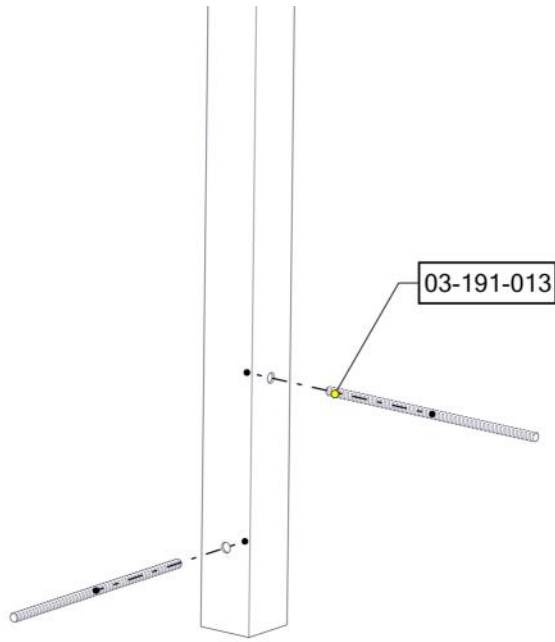

Montering av lekeapparatet / Assembly instructions / Montering av lekredskapet

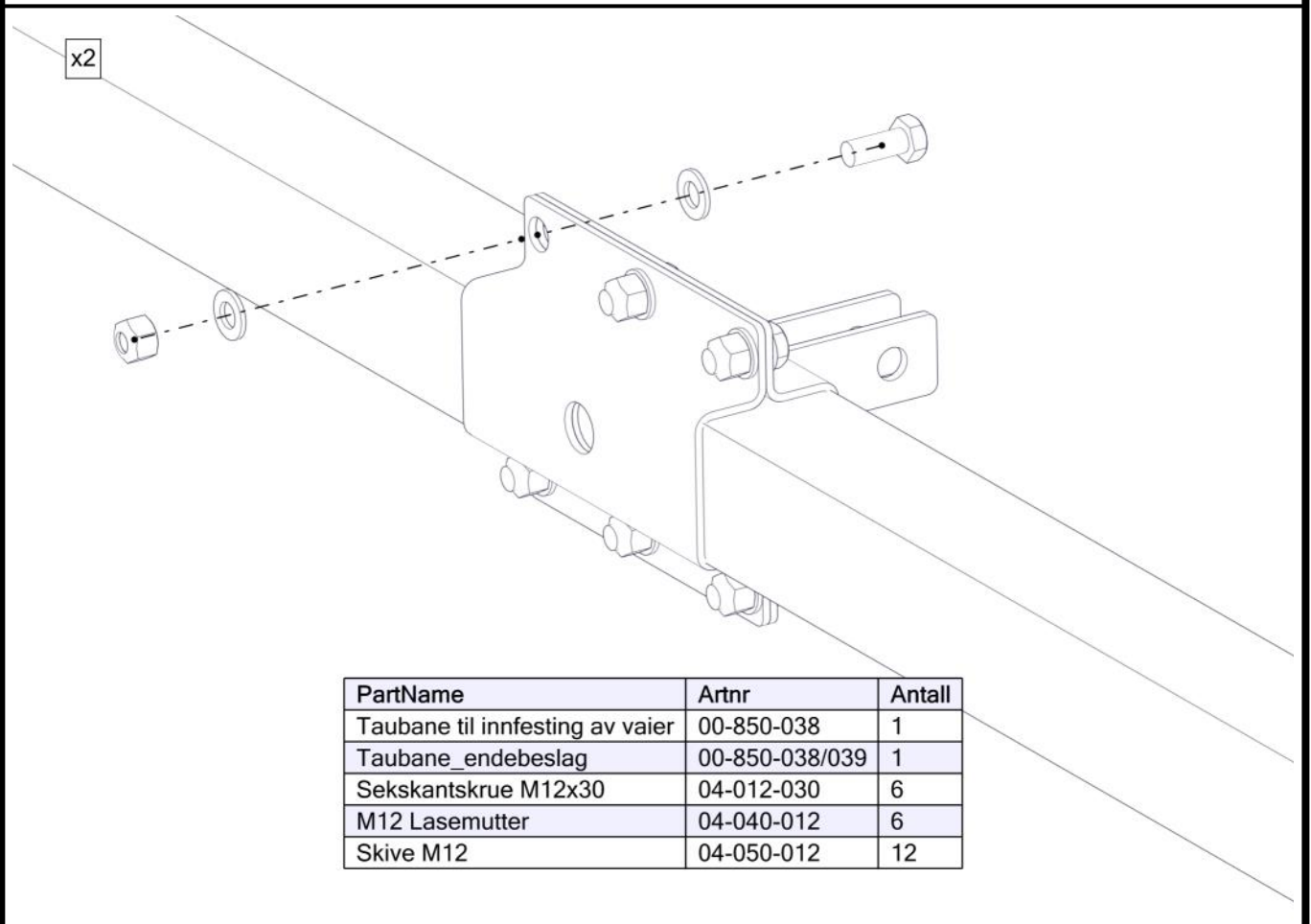
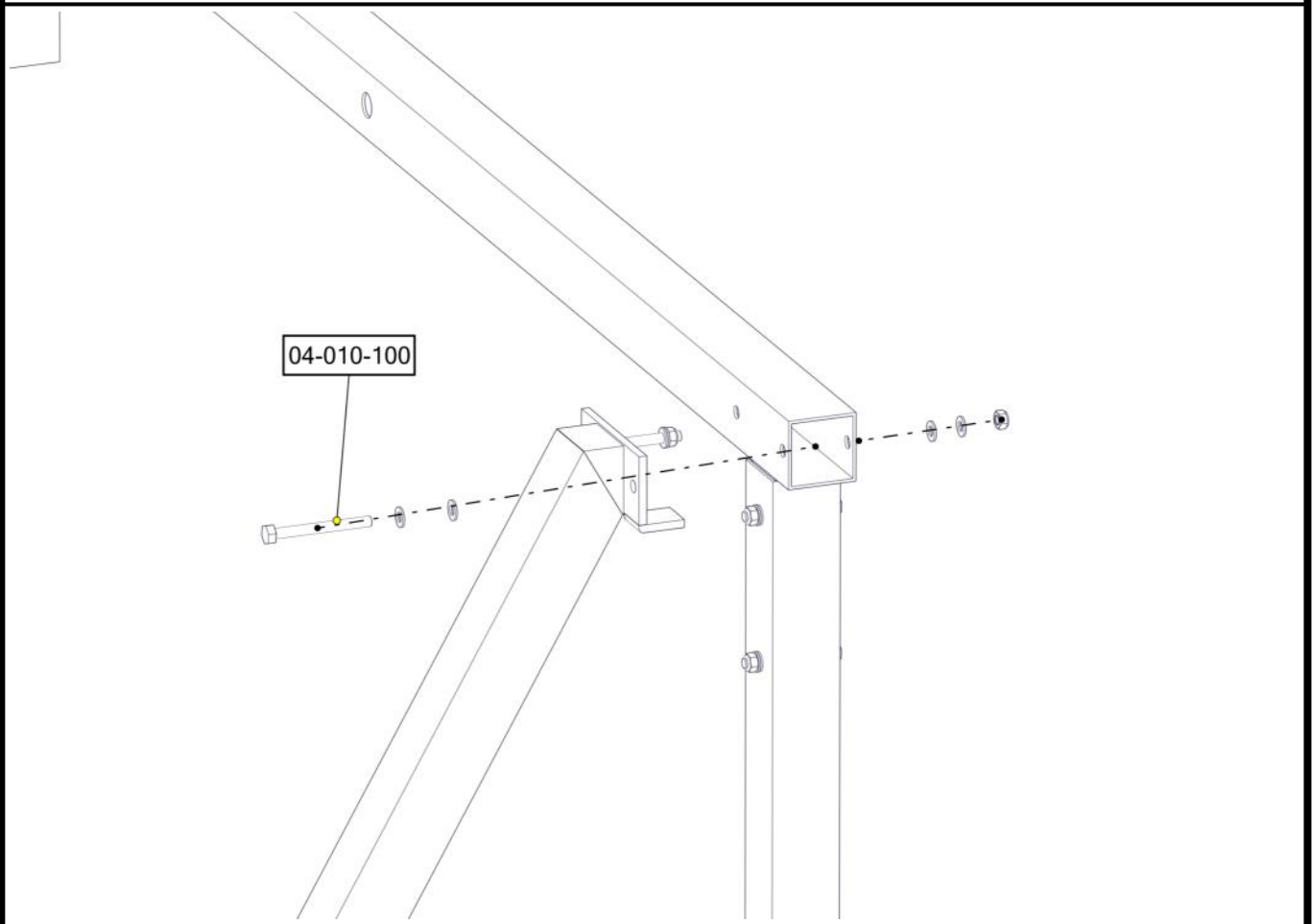

PartName	Artnr	Antall
Taubane til innfesting av vaier	00-850-038	1
Taubane_endebeslag	00-850-038/039	1
Sekskantskrue M12x30	04-012-030	6
M12 Lasemutter	04-040-012	6
Skive M12	04-050-012	12

Montering av lekeapparatet / Assembly instructions / Montering av lekredskapet

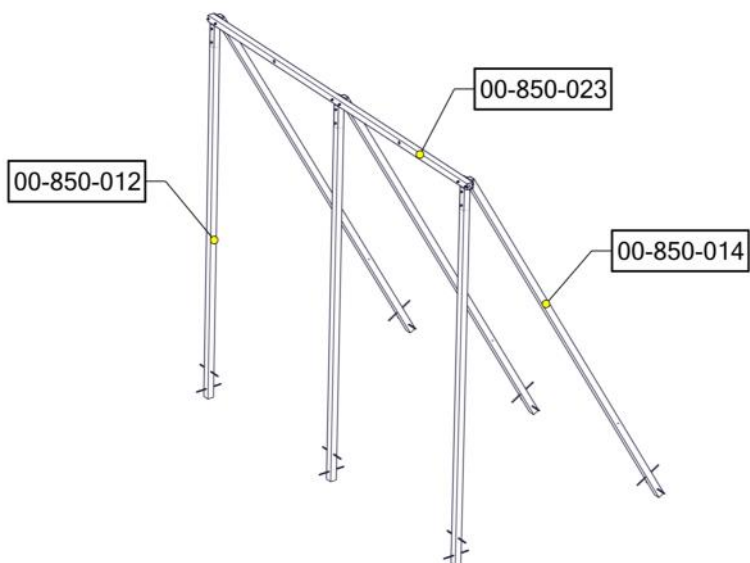

PartName	Artnr	Antall
Taubane_langBein_rett L=3900	00-850-012	3
Taubane_Bein_skråL=4560	00-850-014	3
TauBane overligger L=4220	00-850-023	1
Armering	03-191-013	12
Sekskant skrue M10x90	04-010-090	6

PartName	Artnr	Antall
Sekskant skrue M10x100	04-010-100	6
Låsemutter M10	04-040-010	12
Skive M10	04-050-010	48

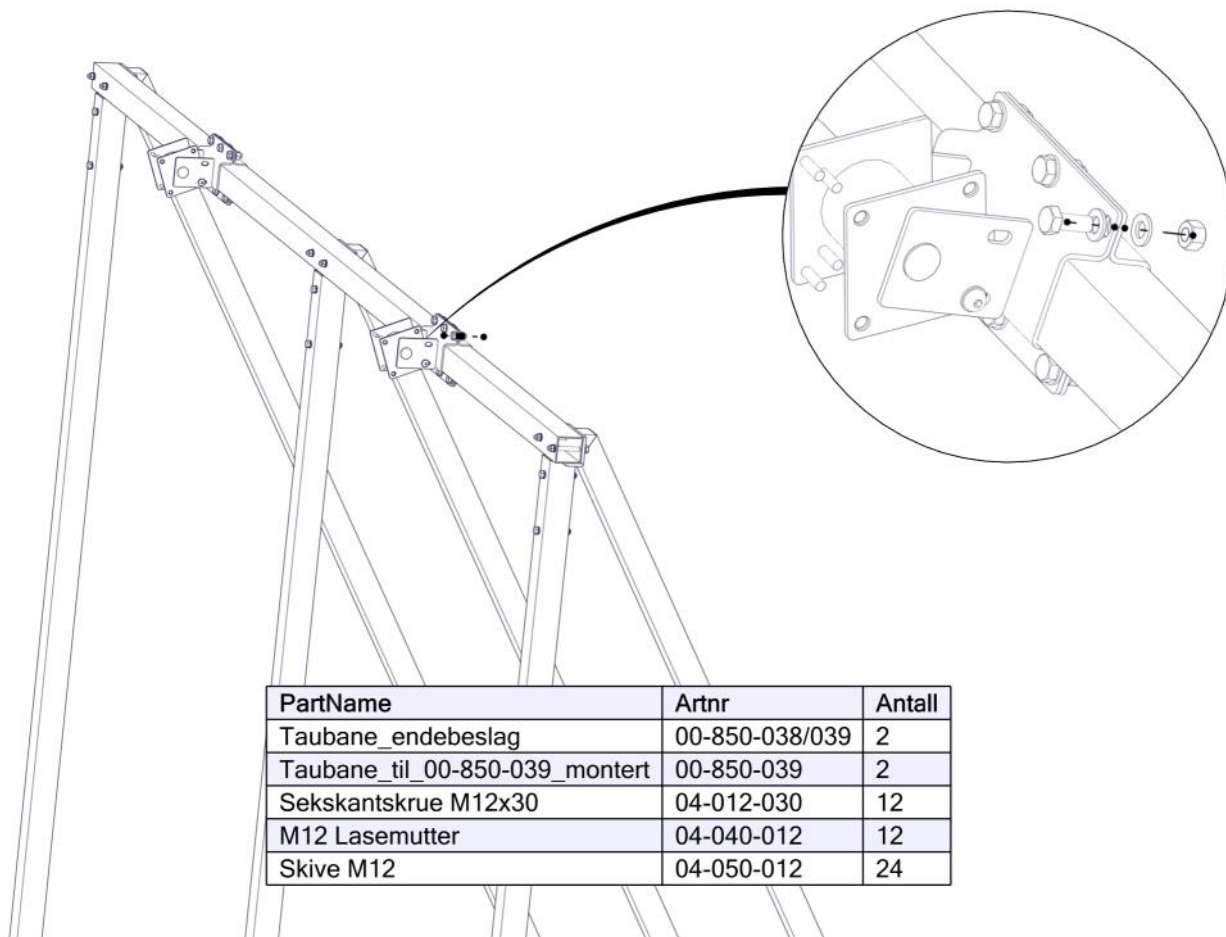

PartName	Artnr	Antall
Taubane_endebeslag	00-850-038/039	2
Taubane_til_00-850-039_montert	00-850-039	2
Sekskantskrue M12x30	04-012-030	12
M12 Lasemutter	04-040-012	12
Skive M12	04-050-012	24

Montering av lekeapparatet / Assembly instructions / Montering av lekredskapet

x2

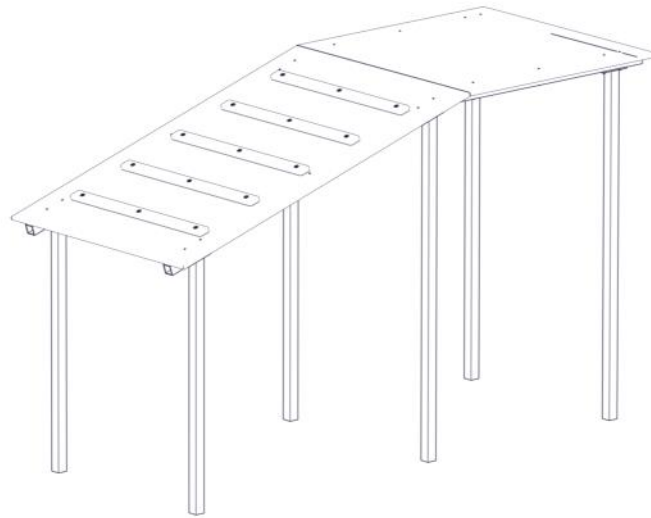

PartName	Artnr	Antall
TaubaneRampe_L= 1350 del3	00-850-015	2
TaubaneRampe_L= 993 del4	00-850-016	2
TaubaneRampe_L= 1380 del2	00-850-017	2
TaubaneRampe underligger (del1)	00-850-018	2
Rampe rett del	00-850-019	1
TaubaneRampe_gulv_skraadel_montert	00-850-020	1

PartName	Artnr	Antall
Sekskant M8x50	04-008-050	6
Sekskant M8x55	04-008-055	12
Møbelknapp M8x25	04-030-025	18
Skive M8	04-050-008	18

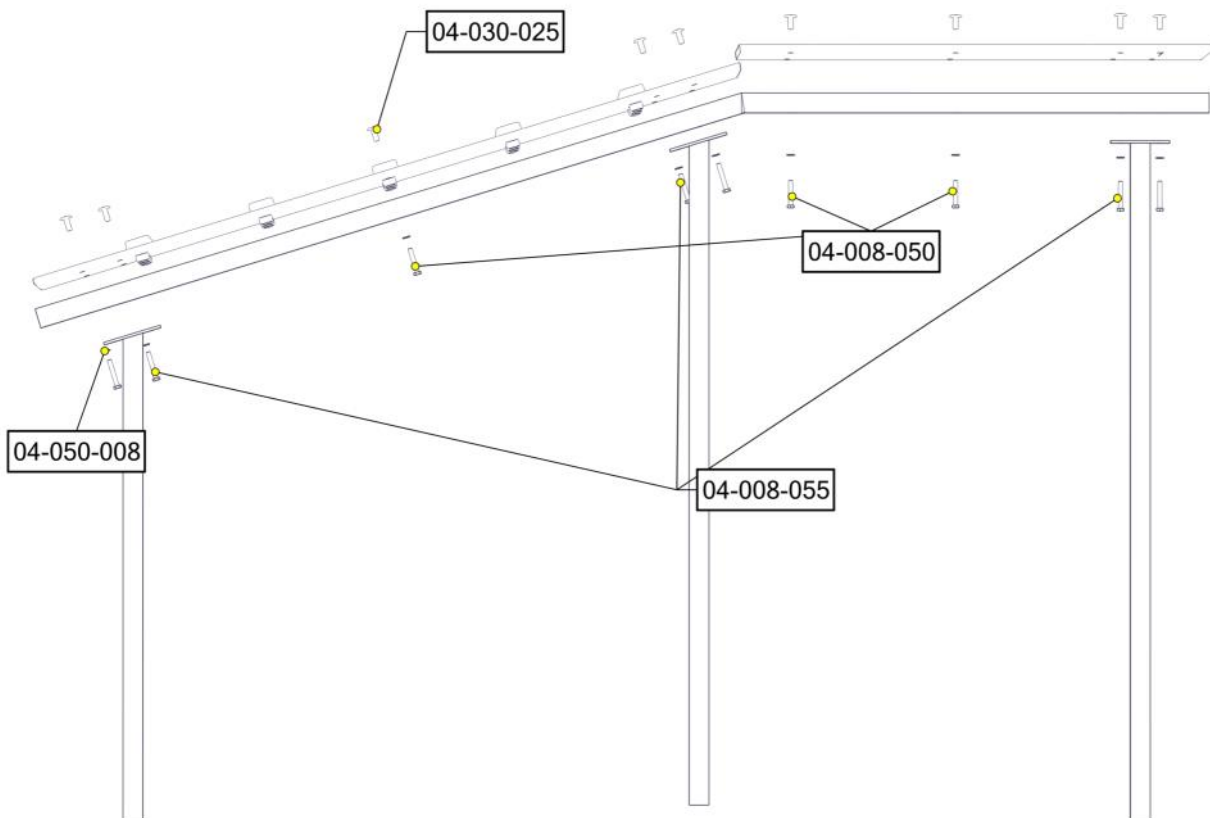

Montering av lekeapparatet / Assembly instructions / Montering av lekredskapet

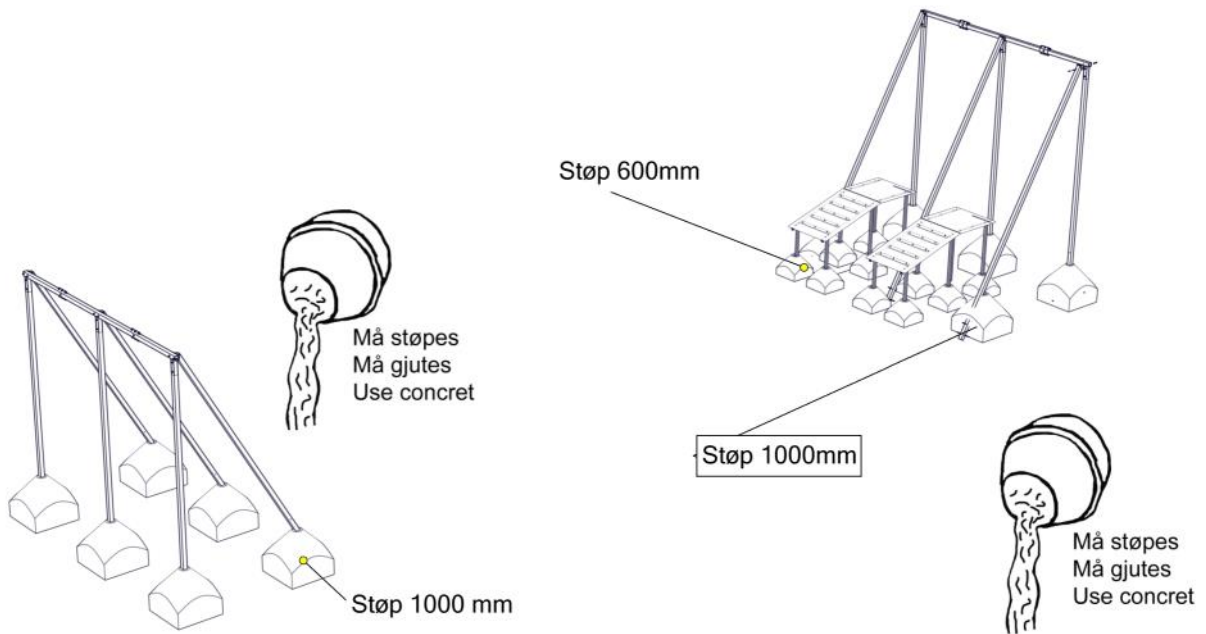
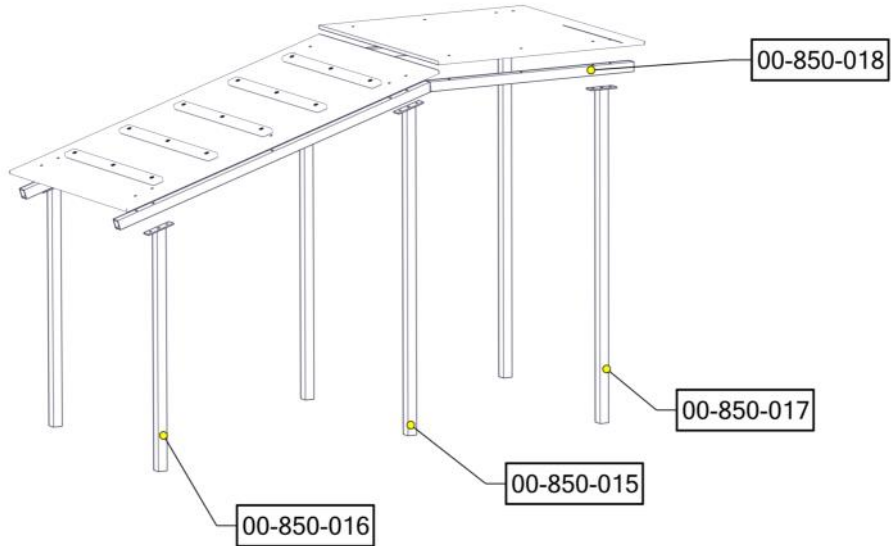



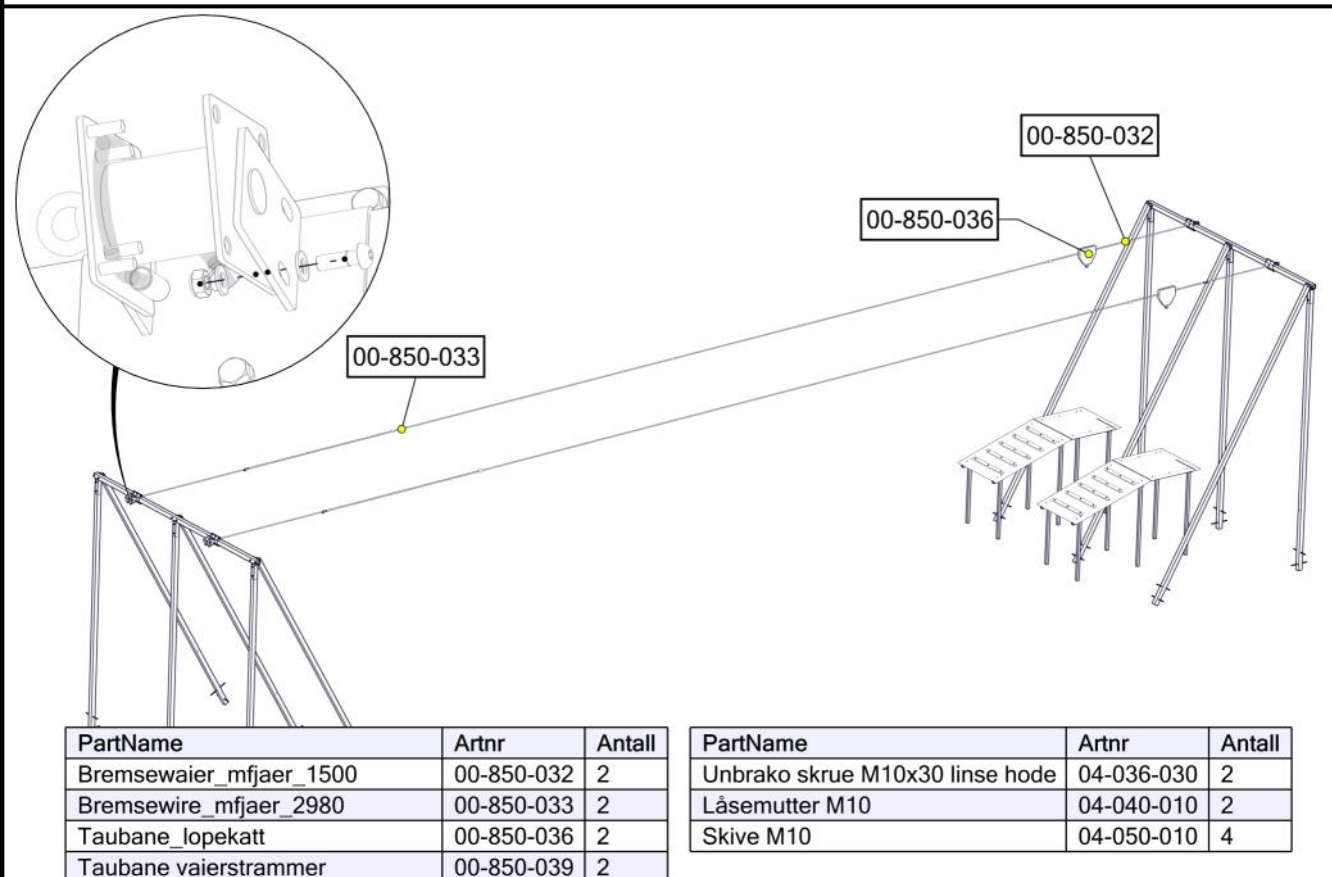
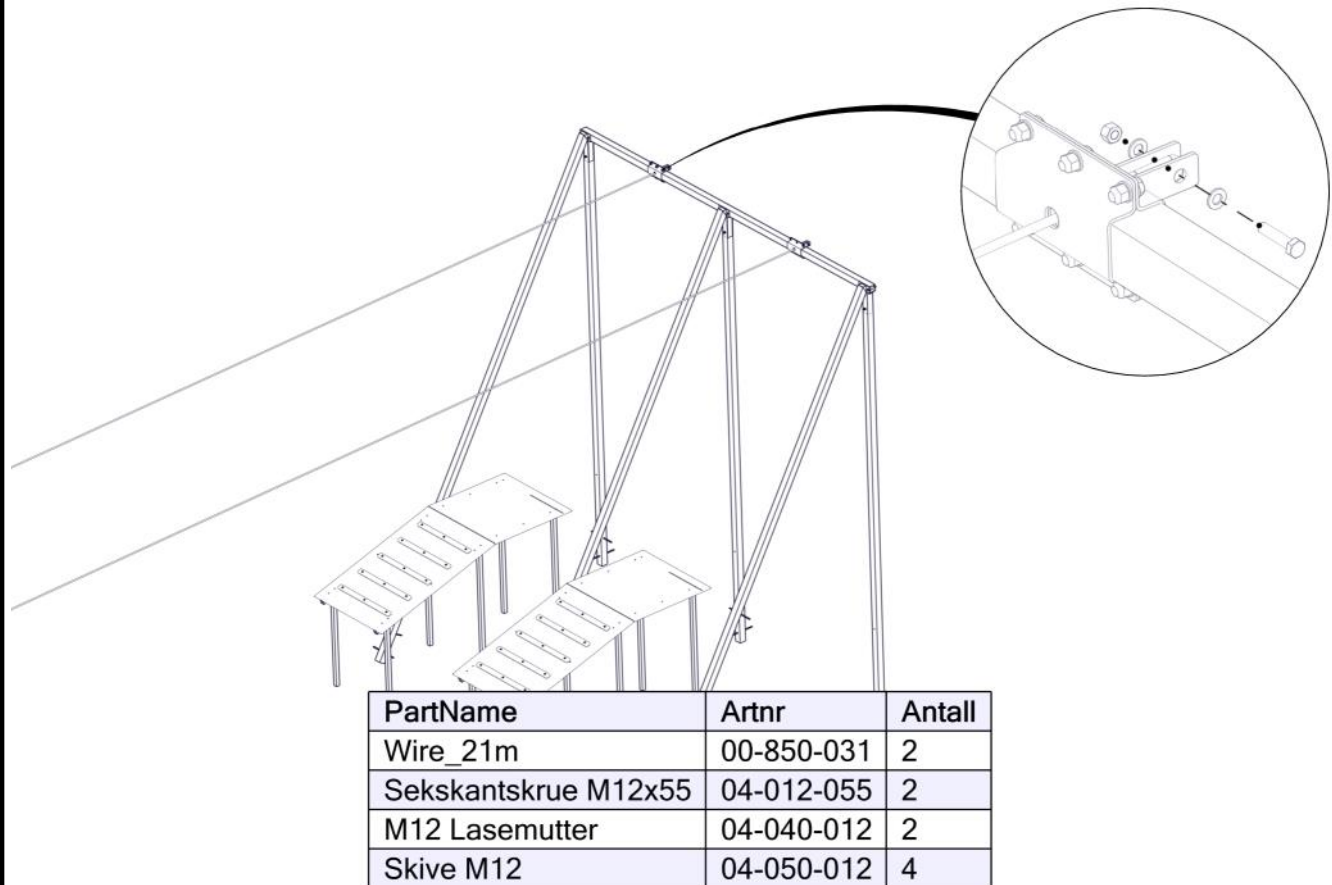

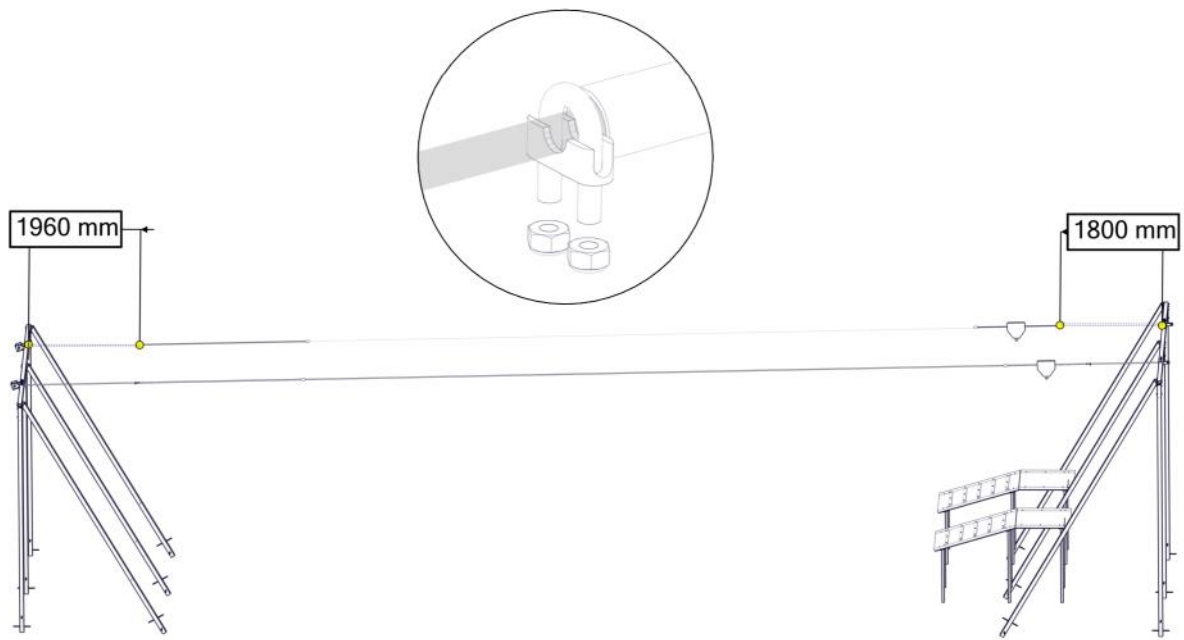

Montering av lekeapparatet / Assembly instructions / Montering av lekredskapet



Montering av lekeapparatet / Assembly instructions / Montering av lekredskapet











Før utstyret tas i bruk / Before play begins / Innan lekredskapet tas i bruk	
N	<ul style="list-style-type: none">● Påse at fallunderlag er utlagt i henhold til gjeldende regler eller vår anbefaling● Fjern alle monteringshjelpemidler (rester av betong, planker, paller, plast, og lignende)● Før utstyret tas i bruk, burde man sjekke at det ikke er fare for at anorakksnorer og lignende som kan hekte seg fast noen steder på lekeapparatet. (Vedlagte snor med dobbe (kneledd) kan brukes til å sjekke at dette er i orden. Se vedlagte veiledning for bruk av denne. Dette gjøres for å oppdage eventuelle feilmonteringer.?)● NB! Bør stå i 2-3 dager før bruk
EN	<ul style="list-style-type: none">● Make sure the area and depth of safer surfacing are according to the current standard, or to the manufacturer's recommendation● Make sure all tools and surplus materials are removed before play begins● PS! When complete, allow 2-3 days for the concrete to set before use
S	<ul style="list-style-type: none">● Kontrollera att fallunderlag är utlagt enligt gällande regler eller vårt rekommendation● Ta bort alla monteringshjälpmedel (rester av betong, plankor, pallar, plast och liknande)● Innan lekredskapet används, kontrollera att anoracksnoddar eller kläder/delar av kläder eller liknande inte kan fastna i några delar på redskapet. (Den bipackade "knävringen" kan man med fördel användas för denna kontroll.● Detta görs för att upptäcka eventuella felmonteringar.)

Boltepakker for / Boltpackage for / Bultpaket för		Sign. _____.		
Taubane dobbel 30-850-110	Navn	Artnr/ dimensjon	Ant	Lev
	Taubane, overligger 4200x70 Sort	00-850-023	2	
	Taubane, rett bein lang 4700x70 Sort	00-850-011	3	
	Taubane, rett bein kort 4200x70 Sort	00-850-012	3	
	Taubane, skrå bein lang 5500x70 Sort	00-850-013	3	
	Taubane, skrå bein kort 4920x70 Sort	00-850-014	3	
	Taubane, bein rampe skrå midt 1350 Sort	00-850-015	4	

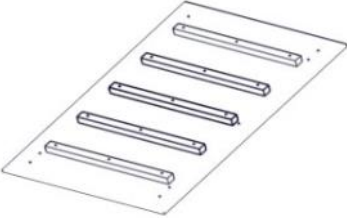

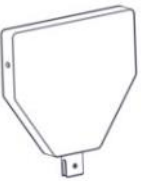
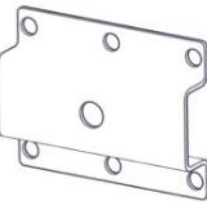
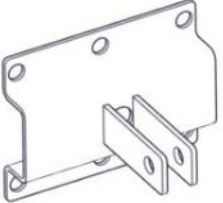

Boltepakker for / Boltpackage for / Bultpaket för

Sign. _____

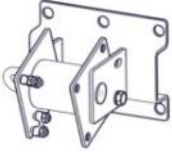
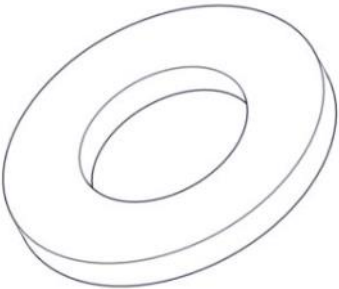
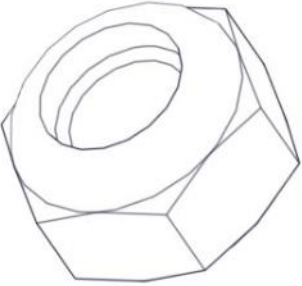
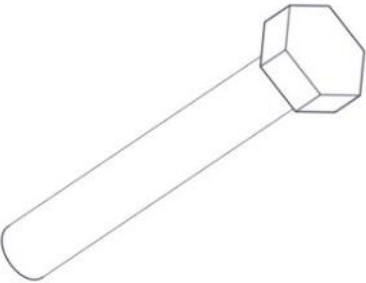
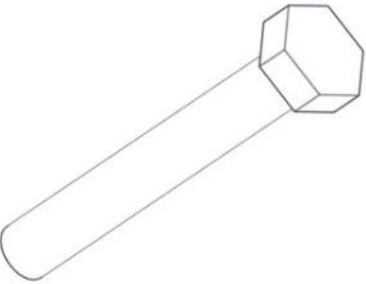
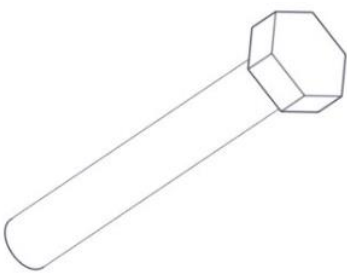
Taubane dobbel 30-850-110	Navn	Artnr/ dimensjon	Ant	Lev
	Taubane, bein rampe skrå lav ende L=993x40 Sort	00-850-016	4	
	Taubane, bein rampe rett høy ende L=1380x40 Sort	00-850-017	4	
	Taubane, rampe underligger L=2396x40 Sort	00-850-018	4	
	Taubane, rampe HPL rett del 1000x960x15 Brun	00-850-019	2	
	Taubane, rampe HPL skrå montert trinn 1500x1000x15 Brun	00-850-020	2	
	Taubane, wire 21meter	00-850-031	2	

Boltepakker for / Boltpackage for / Bultpaket för		Sign. _____.		
Taubane dobbel 30-850-110	Navn	Artnr/ dimensjon	Ant	Lev
	Taubane, bremsewire med fjær 1,5meter	00-850-032	2	
	Taubane, bremsewire med fjær 3meter	00-850-033	2	
	Taubane, sete med plastkjetting Sort	00-850-035	2	
	Taubane, løpekatt komplett	00-850-036	2	
	Taubane, endebeslag For 00-850-038 og 00-850-039	00-850-038/039	4	
	Taubane, brakett for innfesting av wire	00-850-038	2	

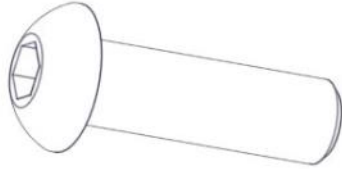
Boltepakker for / Boltpackage for / Bultpaket för		Sign. _____		
Taubane dobbel 30-850-110	Navn	Artnr/ dimensjon	Ant	Lev
	Taubane, vaierstrammer	00-850-039	2	
	Skive M8	04-050-008	40	
	Skive M10	04-050-010	98	
	Skive M12	04-050-012	52	
	Låsemutter M8	04-040-008	2	
	Låsemutter M10	04-040-010	26	
	Låsemutter M12	04-040-012	26	
	Sekskant M8x50	04-008-050	12	
	Sekskant M8x55	04-008-055	24	
	Sekskant M10x90	04-010-090	12	
	Sekskant M10x100	04-010-100	12	
	Sekskant M12x30	04-012-030	24	
	Sekskant M12x55	04-012-055	2	

Boltepakker for / Boltpackage for / Bultpaket för		Sign. _____.		
Taubane dobbel 30-850-110	Navn	Artnr/ dimensjon	Ant	Lev
	Torx M8x35	04-000-035	2	
	Møbelknapp M8x25	04-030-025	36	
	Unbrako skrue linsehodet M10x30	04-036-030	2	
	Produktmerke	00-100-400 (montert hos Søve)	0	

Boltepakker for / Boltpackage for / Bultpaket för

Sign. _____.

Taubane dobbel 30-850-110	Navn	Artnr/ dimensjon	Ant	Lev
	Fundament støp			
	Armering L=300	03-191-013	24	

Revidert

06.11.2023 MNO

Stolpe lengde og med stolpeplassering forandret.

29.01.2023 MNO

Overligger er 80mm lengere, sikkerhetsone er 150mm bredere