

(N) Monteringsanvisning

(UK) Assembly Instructions

(S) Monteringsanvisning

Produkt nr. / Product no. / Produkt nr.

31-185-100

Ordr. nr. _____

Dato. _____

Sign. _____

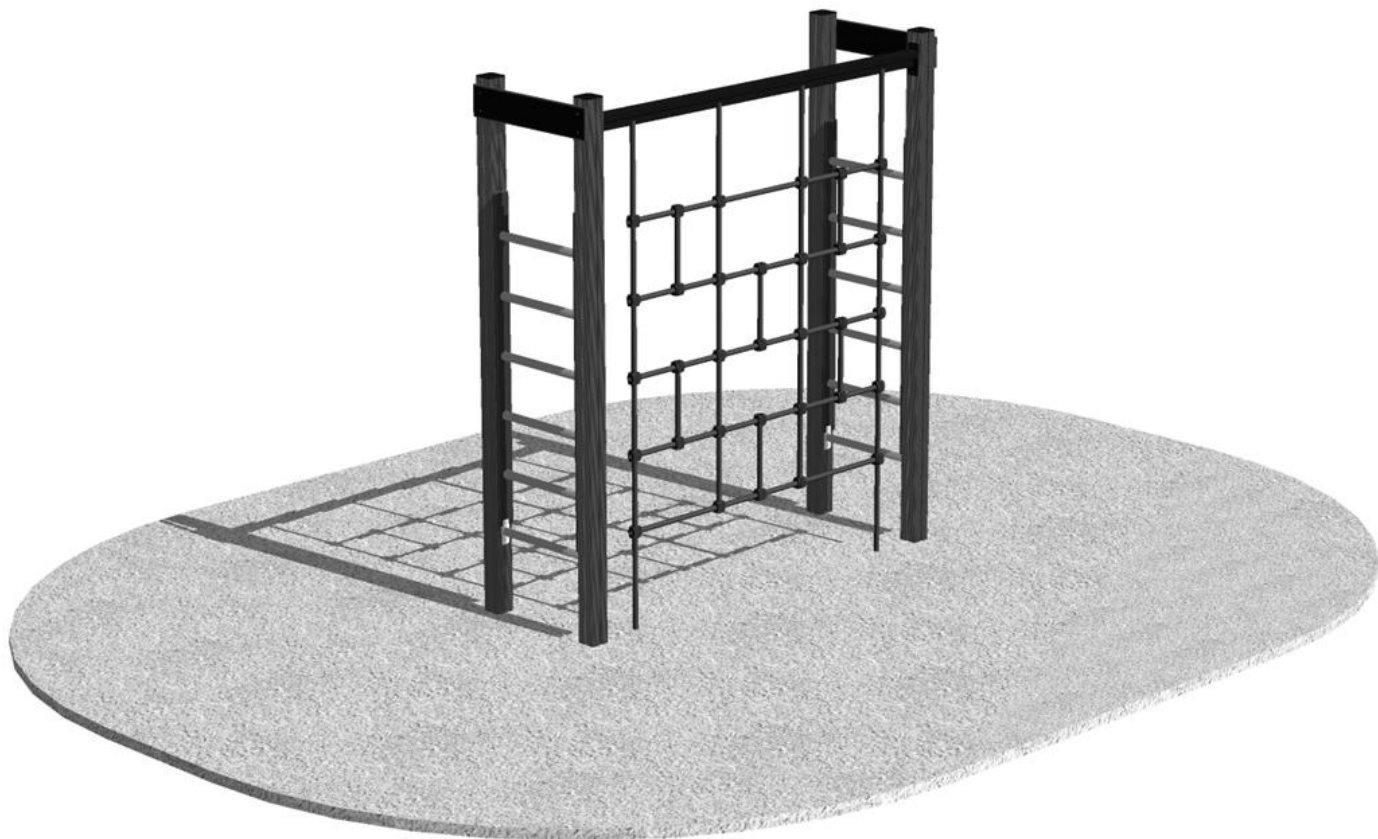

Søve Lekemiljø AS
3830 Ulefoss - Norway
Tlf: +47 35 94 65 65
www.sove.no



Søve AB
412 50 Göteborg
Phone: +46 (0)31 773 97 00
www.sove.se

18.10.2011

- ▣ Les monteringsanvisningen nøye før montering.
 - ▣ Monter elementene i rekkefølgen som vist.
 - ▣ Boltene bør ikke skrues for hardt til før alt er montert, vatret og loddet. Skru så boltene til.
- NB! Ved bruk av drill, kan boltene ryke.
- ▣ På grunn av at solen kan gjøre rutsjeflaten veldig varm, bør rutsjebanens utløp vende mot nord-øst eller nord-vest.
 - ▣ Er lekeutstyret plassert i naturlige ferdselstraséer må området sikres mot spontan gjennomgang.
 - ▣ Innspringningshinder bør vurderes rundt lekeapparater hvor det er stor bevegelse, f.eks. ved huskestativ.
 - ▣ Det bør være fritt innsyn til lekeutstyr som er beregnet for barn under 3 år.

NB! Under monteringsarbeidet må utstyr, som ikke er forankret forsvarlig i bakken, avstives slik at det ikke velte. Området må avstenges under oppsettelse av apparatene med sperrebånd eller lignende.

- ▣ Read the instruction carefully before assembling the play unit.
 - ▣ Assemble the components in the sequence shown in these instructions.
 - ▣ Fixings must not be fully tightened during assembly. Before casting the foundations, the structure must be level and plumb, at which point all fixings are tightened.
- PS! If use of drill, the bolts may be wrecked.
- ▣ Avoid positioning the slide facing due south because of overheating – ideal positions are facing north-east or north-west.
 - ▣ Secure the construction-area to prevent people from walking through it.
 - ▣ Consider installing barriers around play-equipment which gives rise to a lot of activity – i.e. swings.
 - ▣ Ensure that clear vision is possible across the play area so that supervision is possible from any position, particularly where children under 3 years of age will be playing.

NB! During assembly of the equipment, ensure that all structures are securely propped, especially when left overnight. Also ensure that equipment is supported whilst concrete foundations are setting and enclose the area securely to prevent access.

▮ Läs monteringsanvisningen noga före montering.

▮ Montera delarna i den ordningen som anvisas

▮ Skruvarna bör inte skruvas för hårt tills allt är monterat, i våg och lodat.

OBS! Används elektrisk skruvdragare, kan bulten gå sönder. Hårdra därför manuellt!

▮ Solen kan göra att rutchbanan blir väldigt varm. Banans nedfart rekommenderas att vändas i norrlig riktning

▮ Om lekplatsen placeras vid en gångväg mm bör området säkras mot genomfart av gående och cyklister.

▮ Inspringningshinder bör placeras runt lekutrustning med stor rörelse, t ex, gungställning.

▮ Det bör vara fri insyn till lekutrustning beräknat till barn under 3 år.

OBS! Under monteringsarbete bör utrustningen som inte ska förankras i marken, ställs så att den inte kan välta.

Området måste spärras när lekutrustningen byggs upp, med avspärrningsband eller liknande.

2

Nødvendig verktøy / Tools required / Nödvändiga verktyg

N
UK
S

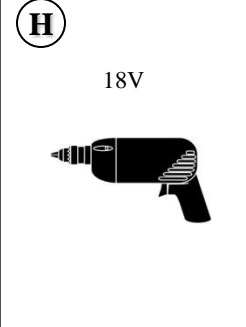
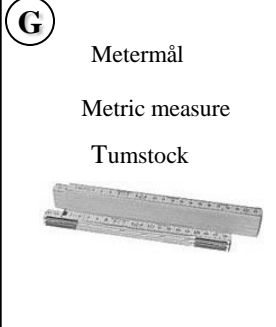
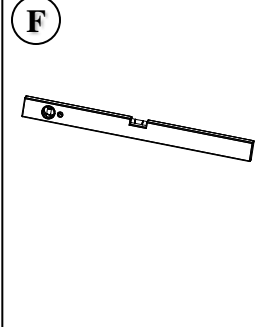
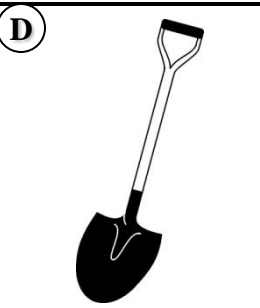
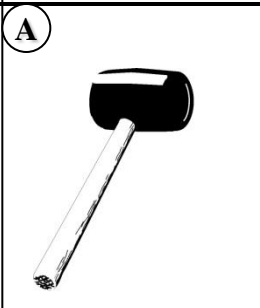

3

Nødvendig antall personer / Number of persons required / Lämpligt antal personer

N
UK
S



4

Anbefalt arealbehov ved montering / Recommended working space / Rekommenderad arealbehov vid montering



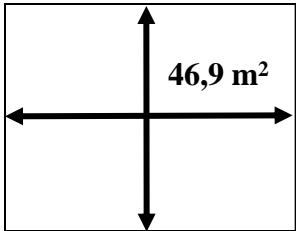





N
UK
S

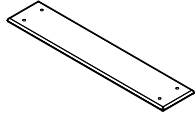
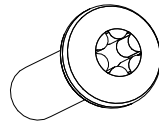
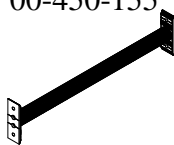
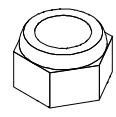
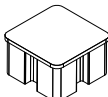

5

Pakkliste for / Parts list for / Packlista för :
31-185-100

Sign. _____

(N) (UK) (S)	Komponenter Components Komponenter	Dimensjon Dimension Dimension	Ant Qty Ant	Lev Lev Lev	Komponenter Components Komponenter	Dimensjon Dimension Dimension	Ant Qty Ant	Lev Lev Lev
	 00-400-016 (N) Med HPL (UK) With HPL (S) Med HPL	3235 x 95x 95	2		(N) Produkt merking (UK) Product marking (S) Produkt märkning		1	
	 00-400-017 (N) Med HPL (UK) With HPL (S) Med HPL	3235 x 95x 95	2		Bolter/skruer Bolts/Screws Bultar/Skruvar	Dimensjon Dimension Dimension	Ant Qty Ant	Lev Lev Lev
	 01-450-109	710 x 145 x 12	2			04-000-025 8 x 25 mm Torx 04-000-035 8 x 35 mm Torx	16 8	
	 00-450-155	520 x 120 x 40	2			04-040-008 8 mm	4	
	 00-400-998  00-400-997 Med hull	55 x 95 x 95 Med hull	4 4			04-060-120 120 x 15 x 8 mm 04-060-160 160 x 15 x 8 mm	8 2	
	 00-450-149	520 x 37	10		Monteringsanvisning Assembly Instructions Monteringsanvisning		1	
	 00-400-801	1980 x 150 x 60	1					
	 N-nett	1560 x 2980	1					5

5 Pakkliste for / Parts list for / Packlista för :
31-185-100













Sign. _____



Forankring / Foundations / Markförankring

00-003-003

(N) Er bestilt Ikke bestilt
 (UK) In order Not in order
 (S) Beställt Ej beställt

00-400-997		
	-4	

	 00-003-100  00-003-101  00-003-102			4	 04-000-035 8 x 35 mm Torx 12
	00-003-103			0	 04-050-008 8 mm 12
	00-003-105				 04-060-120 120 x 15 x 8 mm 8
Eller Or Eller	00-003-106			2	 04-000-040 8 x 40 mm Torx 0
					 04-040-008 8 mm 0
					 04-050-008 8 mm 0
					 04-010-035 10 x 35 mm 4
					 04-040-010 10 mm 4
					 04-050-010 10 mm 4

<input type="radio"/> (N) Med bruk av betong <input type="radio"/> (UK) With use of concrete <input type="radio"/> (S) Med bruk av betong	
	04-060-040 40 x 15 x 8 mm 16
	04-008-055 8 x 55 mm 16

6

Fundamentering med betong / Foundation concrete / Förankring med betong



(N) Bakkenivå (UK) Ground level (S) Marknivå

(N) Støtsand
(UK) Safer surface
(S) Stridsand

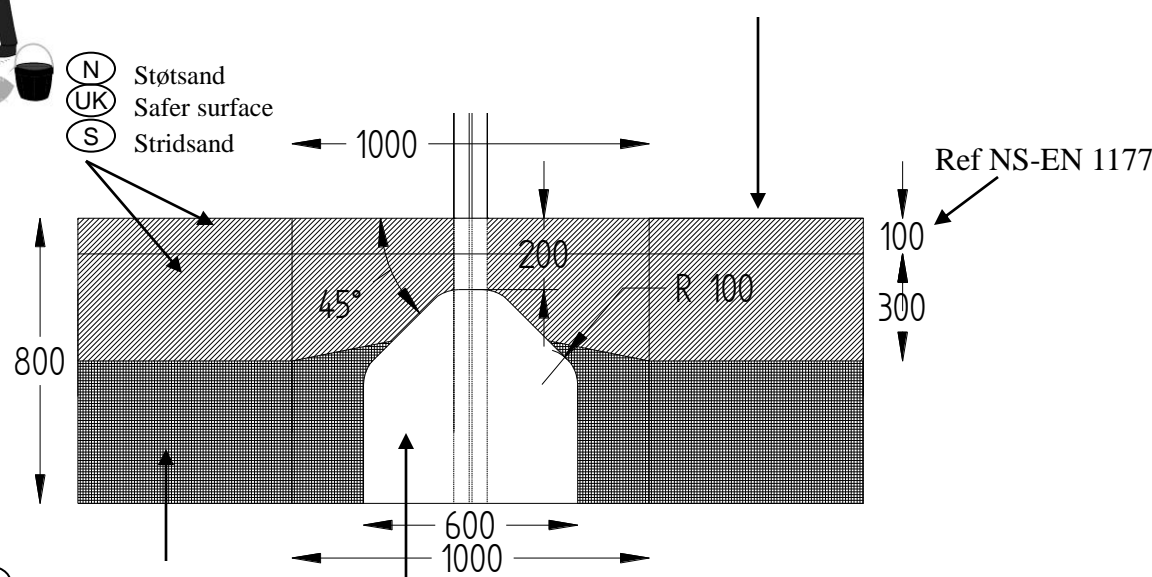

(N) Komprimert masse. betong
(UK) Compressed mass. concrete
(S) Komprimerad massa. betong

6

Fundamentering uten betong / Foundation without concrete / Förankring utan betong

(N) Bakkenivå (UK) Ground level (S) Marknivå

(N) Støtsand
(UK) Safer surface
(S) Stridsand

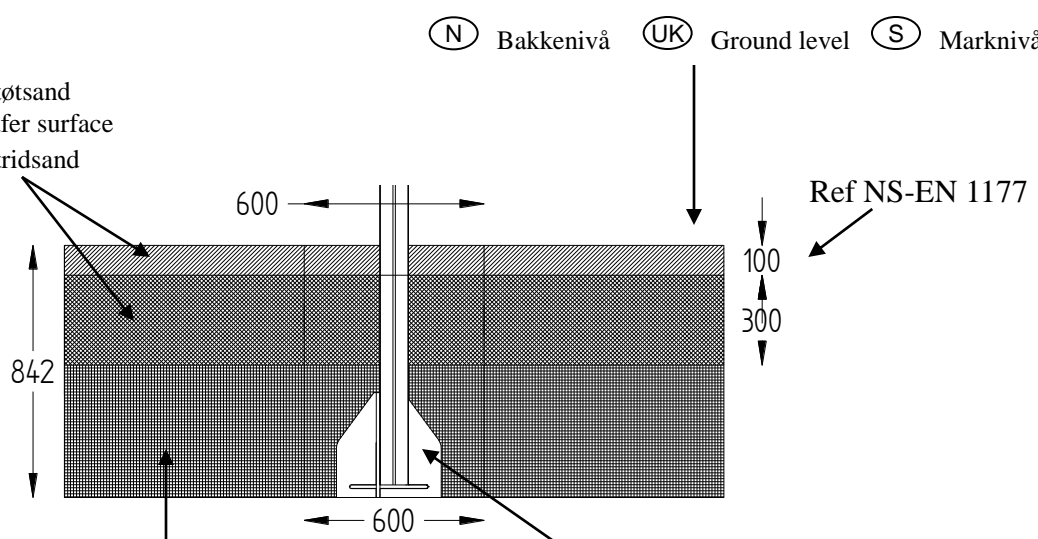

(N) Komprimert masse Støpefri nedgraving
(UK) Compressed mass Concrete-free anchor
(S) Komprimerad massa Nedgravningsfundament

(N) Alle mål er oppgitt i millimeter
(UK) Scale measured in mm
(S) Alla mått är i millimeter.

- (N) For klatrenett
- (UK) For climbing net
- (S) För klätternät

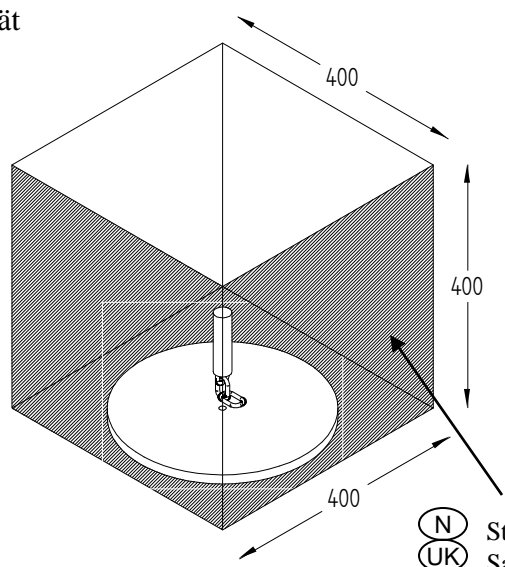
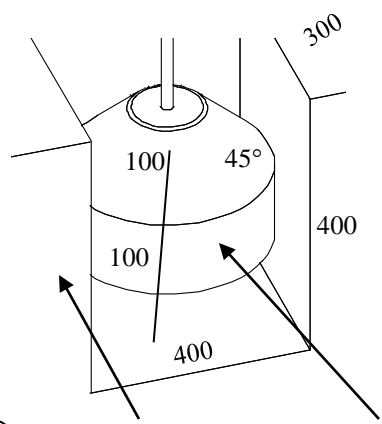

- (N) Komprimert masse. betong
- (UK) Compressed mass. concrete
- (S) Komprimerad massa. betong

- (N) Støtsand
- (UK) Safer surface
- (S) Stridsand

- (N) Alle mål er oppgitt i millimeter
- (UK) Scale measured in mm
- (S) Alla mått är i millimeter.

6

(N) Dybde for støping og forankring

(UK) Depth of foundations /

(S) Djup för gjutning och markförankring

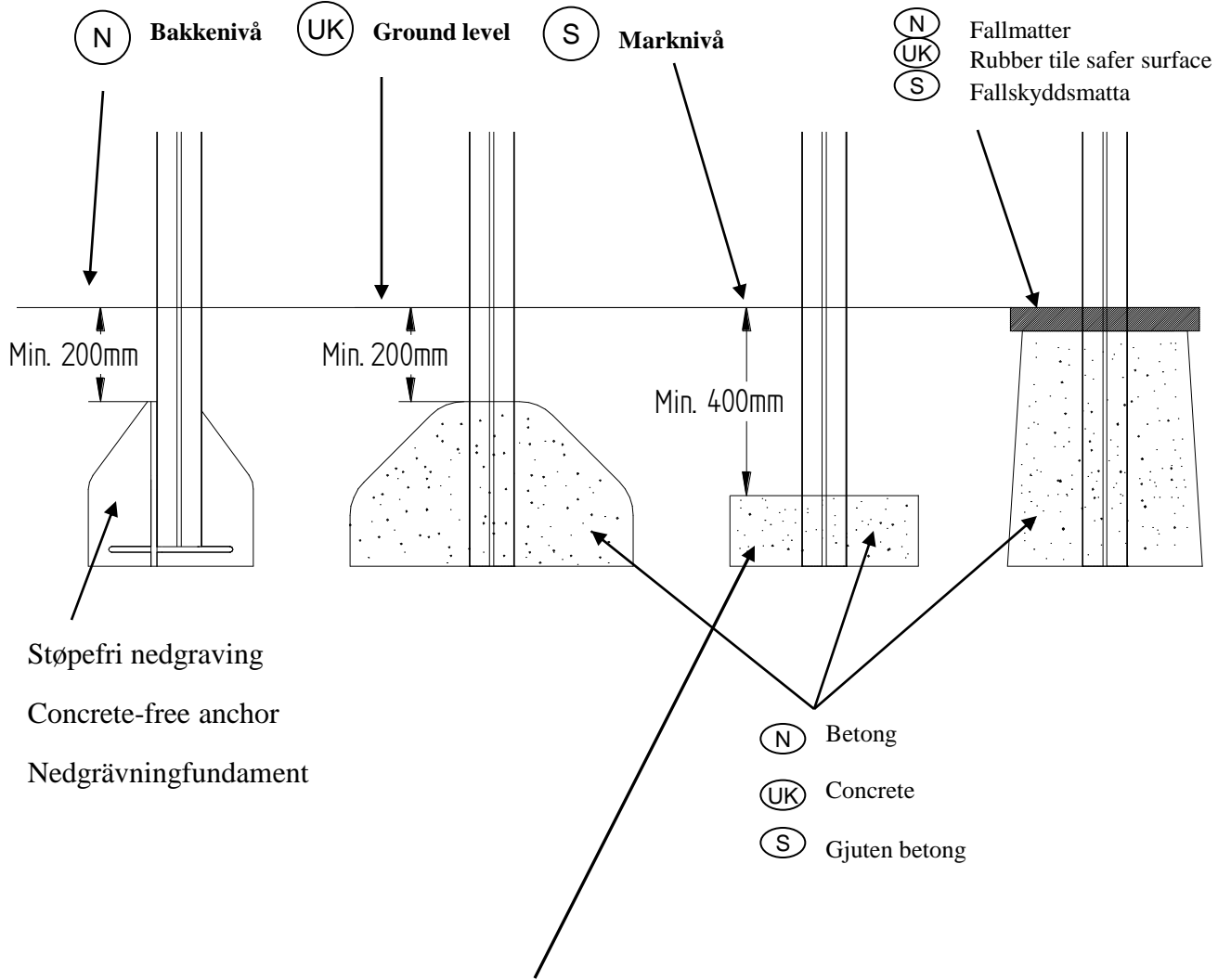

(N) Støpefri nedgraving
 (UK) Concrete-free anchor
 (S) Nedgrävningfundament

(N) Betong
 (UK) Concrete
 (S) Gjuten betong

(N) Denne støpemetoden anbefales ikke grunnet dårlig stabilitet av lekeapparatet.

(UK) This anchor is recommend not to use because of poor stability of the play unit.

(S) Denna förankring avrådes från att användas, därför att lekutrustningen får dålig fäste.

①

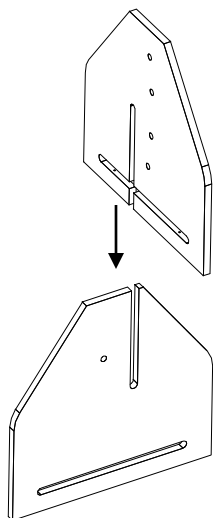

②

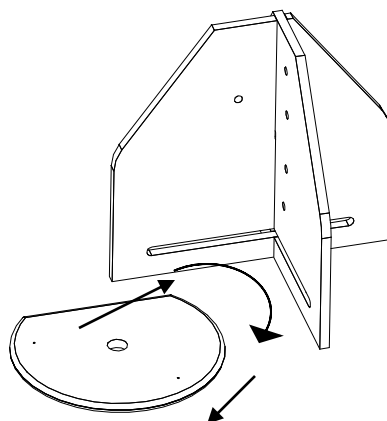

③

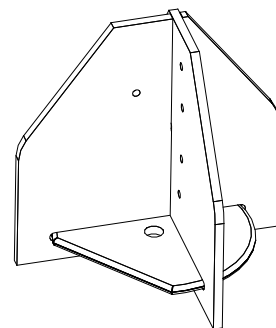

④

04-060-120 x 2
120 x 15 x 8 mm

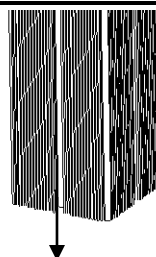

04-000-035 x 3
8 x 35 mm Torx

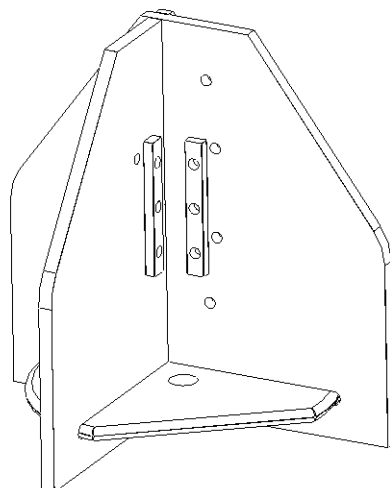

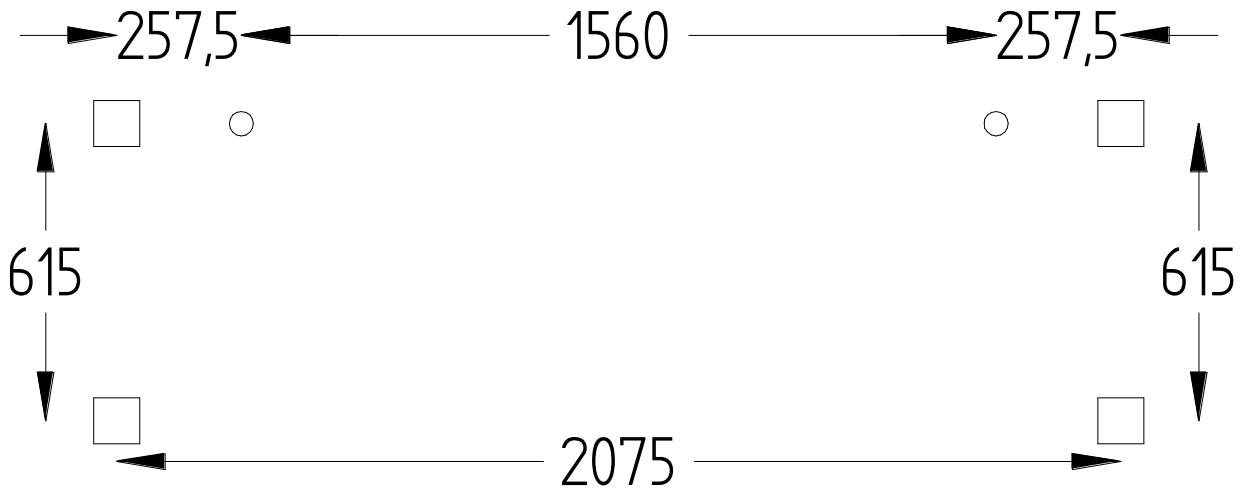

(N)

Alle mål er oppgitt i millimeter

(UK)

Scale measured in mm

(S)

Alla mått är i millimeter.

7

Sikkerhetszone / Safety zone / Säkerhetszon

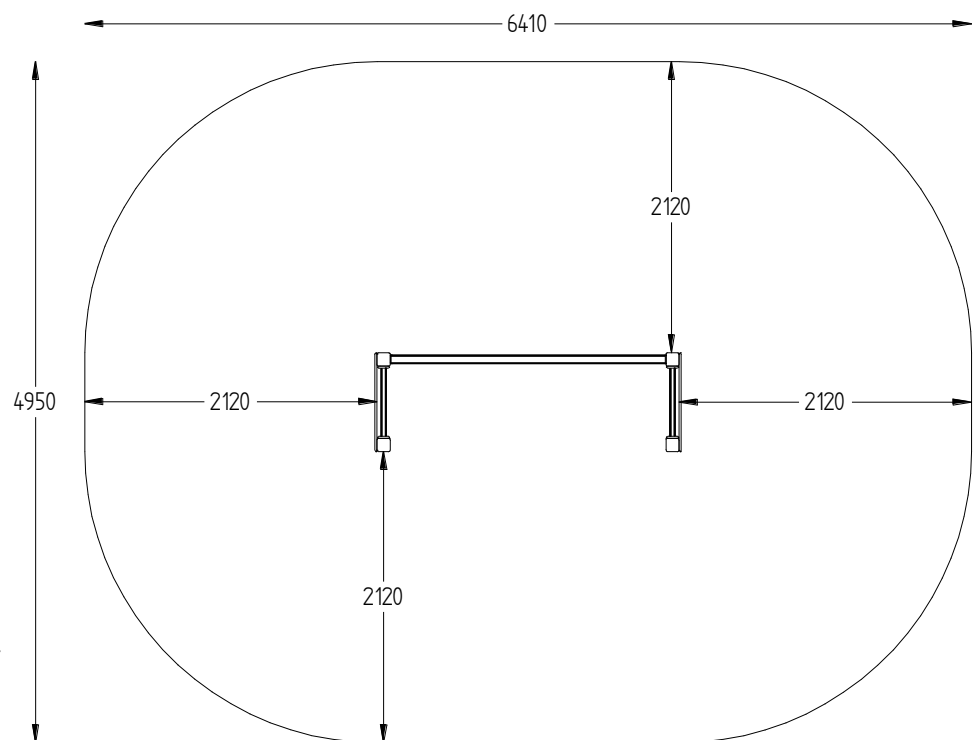

(N)

Alle mål er oppgitt i millimeter

(UK)

Scale measured in mm

(S)

Alla mått är i millimeter.

8

Fallhøyder / Free height of fall / Fallhöjder

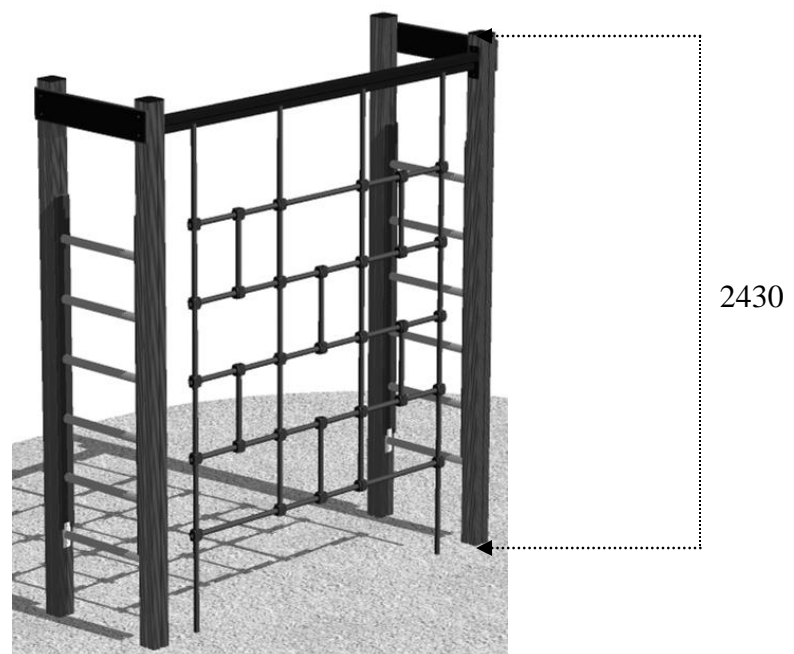

(N)

Alle mål er oppgitt i millimeter

(UK)

Scale measured in mm

(S)

Alla mått är i millimeter.

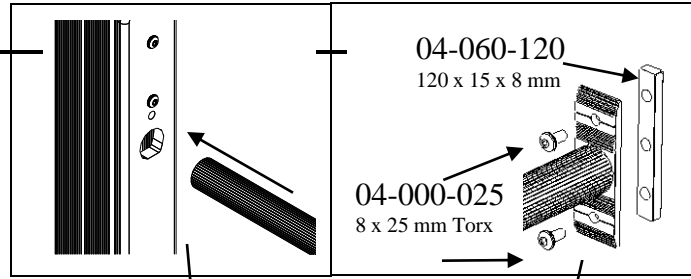
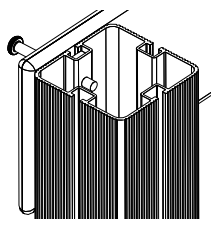

(N) Med bruk av betong
 (UK) With use of concrete
 (S) Med bruk av betong

00-400-997

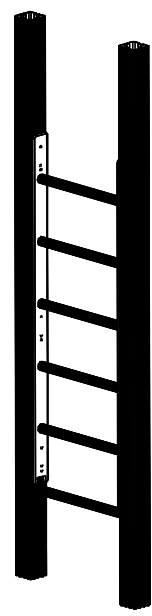
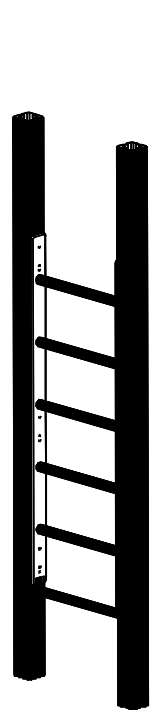
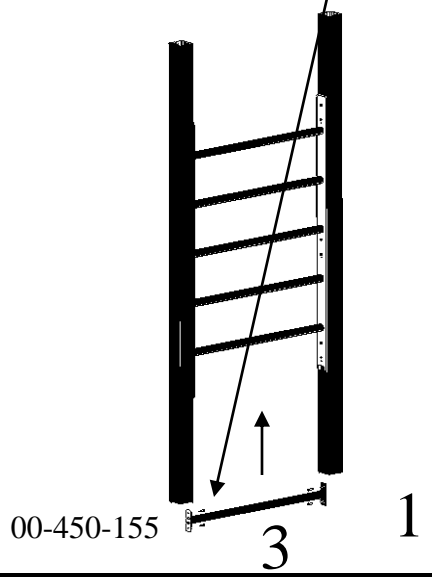
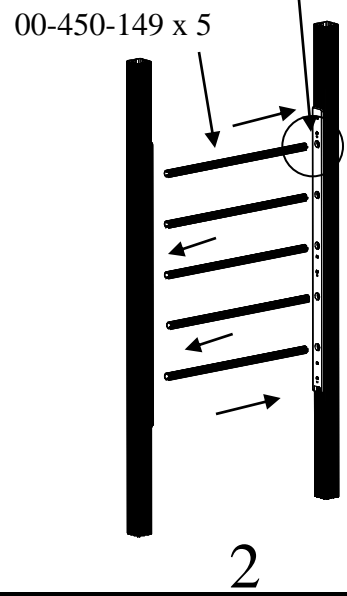
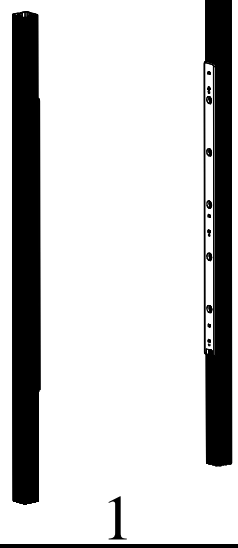

04-060-120

120 x 15 x 8 mm

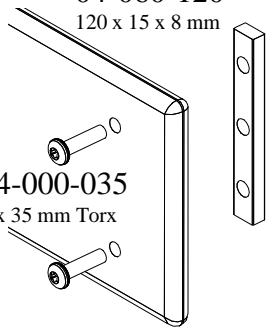

04-000-035

8 x 35 mm Torx

01-450-109

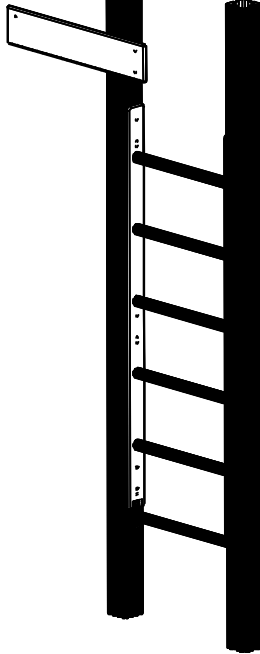

01-450-109

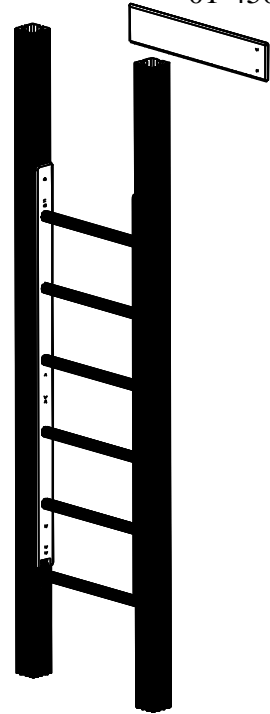

52,5 mm

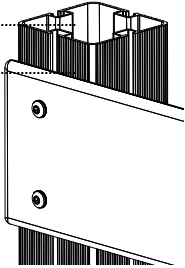

3

00-400-801

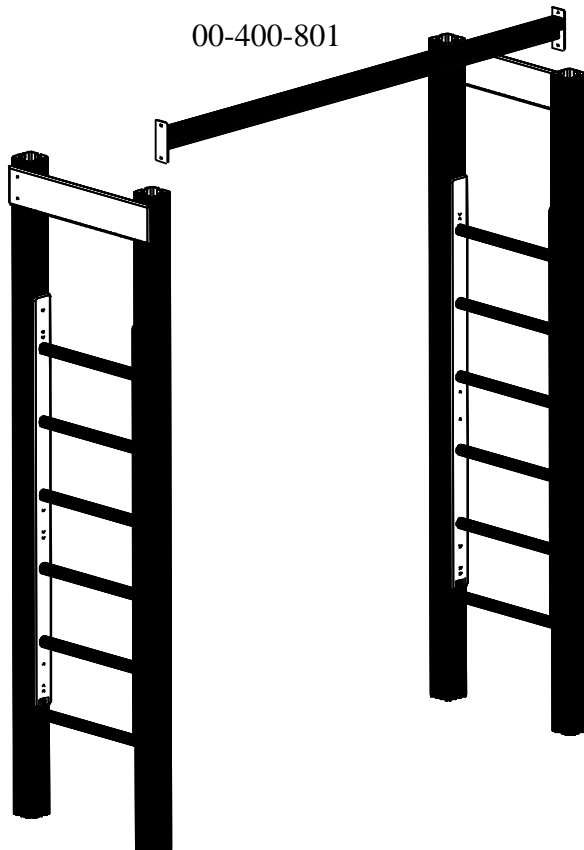

04-000-025

8 x 25 mm Torx

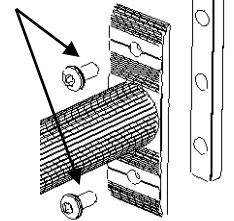

04-060-160
160 x 15 x 8 mm

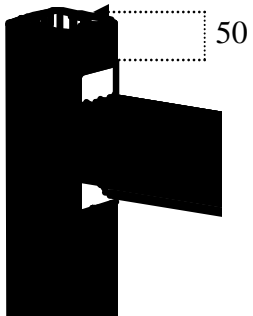

50

4

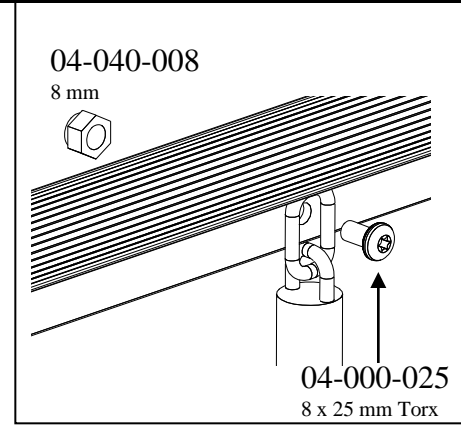
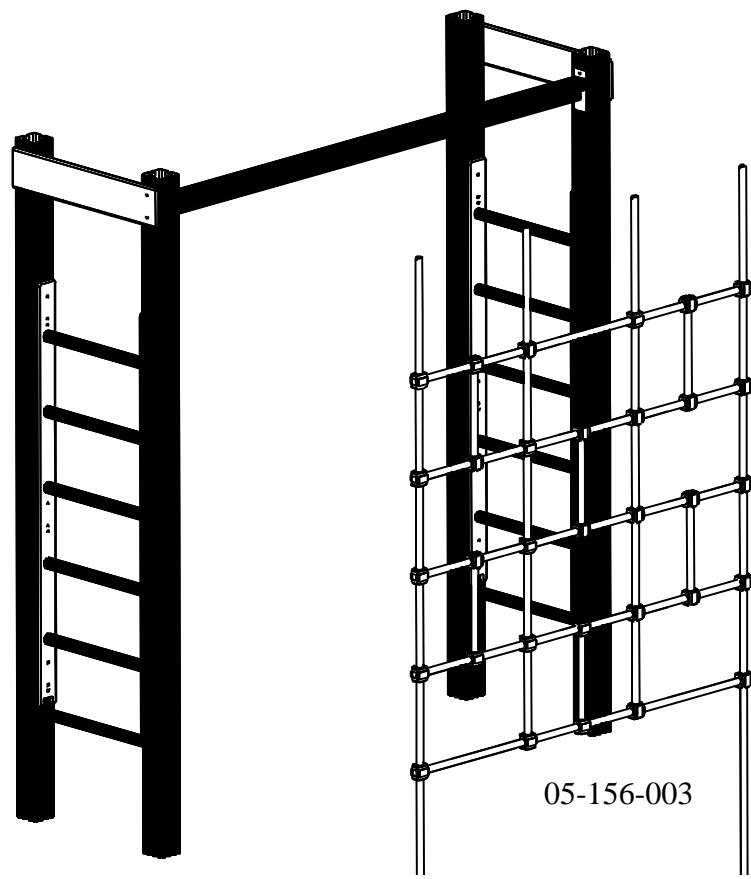

5

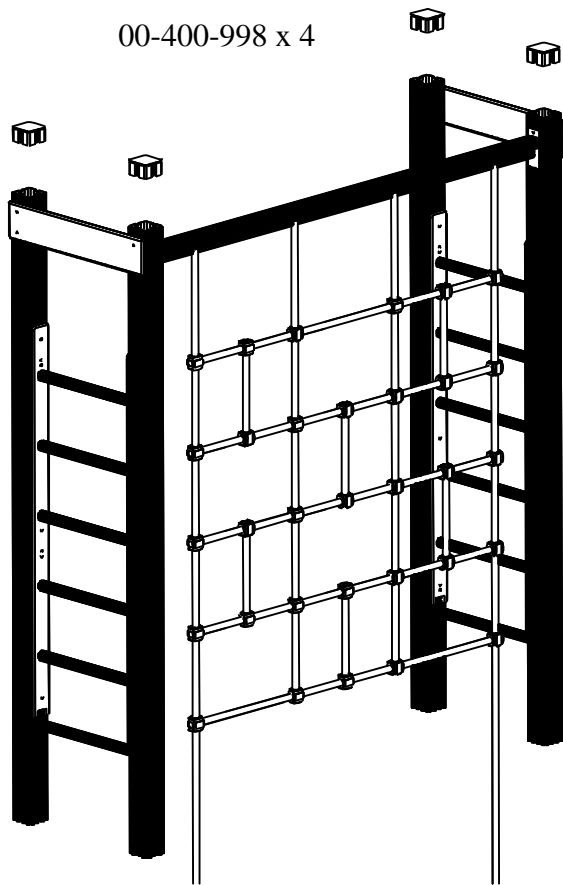







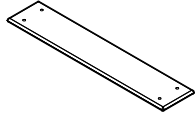
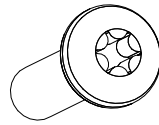
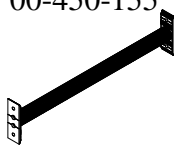
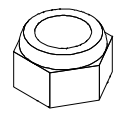
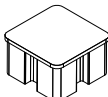

6

5

Pakkliste for / Parts list for / Packlista för :
31-185-100

Sign. _____

(N) (UK) (S)	Komponenter Components Komponenter	Dimensjon Dimension Dimension	Ant Qty Ant	Lev Lev Lev	Komponenter Components Komponenter	Dimensjon Dimension Dimension	Ant Qty Ant	Lev Lev Lev
	 00-400-016 (N) Med HPL (UK) With HPL (S) Med HPL	3235 x 95x 95	2		(N) Produkt merking (UK) Product marking (S) Produkt märkning		1	
	 00-400-017 (N) Med HPL (UK) With HPL (S) Med HPL	3235 x 95x 95	2		Bolter/skruer Bolts/Screws Bultar/Skruvar	Dimensjon Dimension Dimension	Ant Qty Ant	Lev Lev Lev
	 01-450-109	710 x 145 x 12	2			04-000-025 8 x 25 mm Torx 04-000-035 8 x 35 mm Torx	16 8	
	 00-450-155	520 x 120 x 40	2			04-040-008 8 mm	4	
	 00-400-998  00-400-997 Med hull	55 x 95 x 95 Med hull	4 4			04-060-120 120 x 15 x 8 mm 04-060-160 160 x 15 x 8 mm	8 2	
	 00-450-149	520 x 37	10		Monteringsanvisning Assembly Instructions Monteringsanvisning		1	
	 00-400-801	1980 x 150 x 60	1					
	 05-156-003 N-nett	1560 x 2980	1					

5 Pakkliste for / Parts list for / Packlista för :
31-185-100













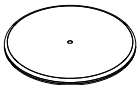

Sign. _____

Forankring / Foundations / Markförankring

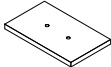

00-003-003

(N) Er bestilt Ikke bestilt
 (UK) In order Not in order
 (S) Beställt Ej beställt

00-400-997 	-4	
---	----	--

 00-003-100  00-003-101  00-003-102					 04-000-035 8 x 35 mm Torx 12
					 04-050-008 8 mm 12
				4	 04-060-120 120 x 15 x 8 mm 8
00-003-103 					 04-000-040 8 x 40 mm Torx 0
					 04-040-008 8 mm 0
				0	 04-050-008 8 mm 0
00-003-105 	Eller Or Eller				 04-010-035 10 x 35 mm 4
00-003-106 					 04-040-010 10 mm 4
				2	 04-050-010 10 mm 4

(N) Med bruk av betong (UK) With use of concrete
 (S) Med bruk av betong

	04-060-040 40 x 15 x 8 mm	16	
	04-008-055 8 x 55 mm	16	