

(N) Monteringsanvisning

(UK) Assembly Instructions

(S) Monteringsanvisning

Produkt nr. / Product no. / Produkt nr.

31-400-050

Ordr. nr. _____

Dato. _____

Sign. _____

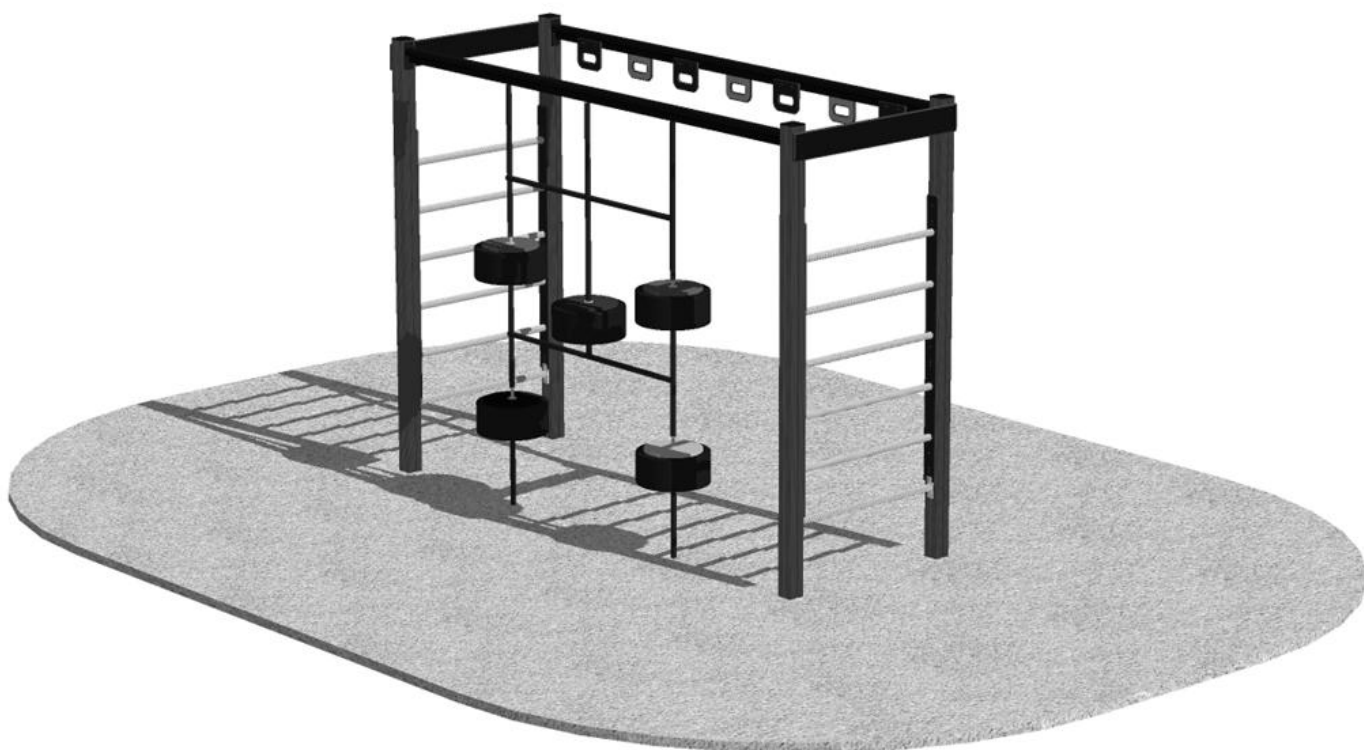

Søve Lekemiljø AS
3830 Ulefoss - Norway
Tlf: +47 35 94 65 65
www.sove.no



Søve AB
Göteborg
Phone: +46 (0)31 773 97 00
www.sove.se

27.05.2010

1

Monteringstips / Assembly Advice / Monteringsstips

N

- ▣ Les monteringsanvisningen nøye før montering.
 - ▣ Monter elementene i rekkefølgen som vist.
 - ▣ Boltene bør ikke skrues for hardt til før alt er montert, vatret og loddet. Skru så boltene til.
- NB! Ved bruk av drill, kan boltene ryke.
- ▣ På grunn av at solen kan gjøre rutsjeflaten veldig varm, bør rutsjebanens utløp vende mot nord-øst eller nord-vest.
 - ▣ Er lekeutstyret plassert i naturlige ferdselstraséer må området sikres mot spontan gjennomgang.
 - ▣ Innspringningshinder bør vurderes rundt lekeapparater hvor det er stor bevegelse, f.eks. ved huskestativ.
 - ▣ Det bør være fritt innsyn til lekeutstyr som er beregnet for barn under 3 år.

NB! Under monteringsarbeidet må utstyr, som ikke er forankret forsvarlig i bakken, avstives slik at det ikke velte. Området må avstenges under oppsettelse av apparatene med sperrebånd eller lignende.

UK

- ▣ Read the instruction carefully before assembling the play unit.
 - ▣ Assemble the components in the sequence shown in these instructions.
 - ▣ Fixings must not be fully tightened during assembly. Before casting the foundations, the structure must be level and plumb, at which point all fixings are tightened.
- PS! If use of drill, the bolts may be wrecked.
- ▣ Avoid positioning the slide facing due south because of overheating – ideal positions are facing north-east or north-west.
 - ▣ Secure the construction-area to prevent people from walking through it.
 - ▣ Consider installing barriers around play-equipment which gives rise to a lot of activity – i.e. swings.
 - ▣ Ensure that clear vision is possible across the play area so that supervision is possible from any position, particularly where children under 3 years of age will be playing.

NB! During assembly of the equipment, ensure that all structures are securely propped, especially when left overnight. Also ensure that equipment is supported whilst concrete foundations are setting and enclose the area securely to prevent access.

▮ Läs monteringsanvisningen noga före montering.

▮ Montera delarna i den ordningen som anvisas

▮ Skruvarna bör inte skruvas för hårt tills allt är monterat, i våg och lodat.

OBS! Används elektrisk skruvdragare, kan bulten gå sönder. Hårdra därför manuellt!

▮ Solen kan göra att rutchbanan blir väldigt varm. Banans nedfart rekommenderas att vändas i norrlig riktning

▮ Om lekplatsen placeras vid en gångväg mm bör området säkras mot genomfart av gående och cyklister.

▮ Inspringningshinder bör placeras runt lekutrustning med stor rörelse, t ex, gungställning.

▮ Det bör vara fri insyn till lekutrustning beräknat till barn under 3 år.

OBS! Under monteringsarbete bör utrustningen som inte ska förankras i marken, ställs så att den inte kan välta.

Området måste spärras när lekutrustningen byggs upp, med avspärrningsband eller liknande.

2

Nødvendig verktøy / Tools required / Nödvändiga verktyg

N
UK
S

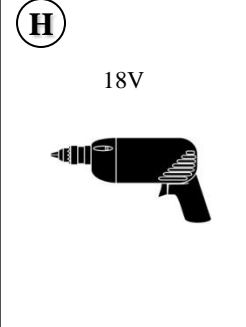
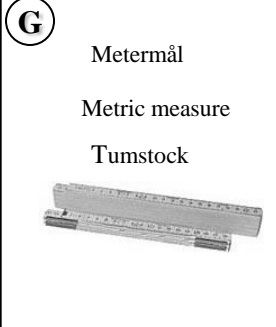
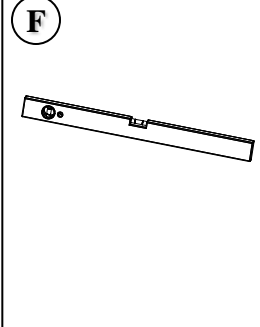
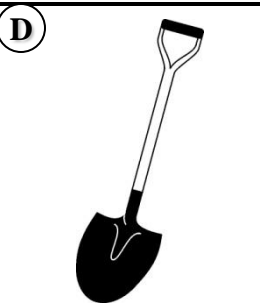
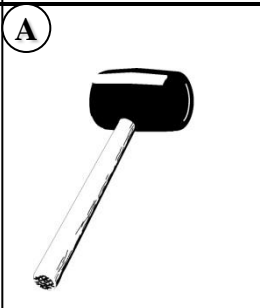

3

Nødvendig antall personer / Number of persons required / Lämpligt antal personer

N
UK
S

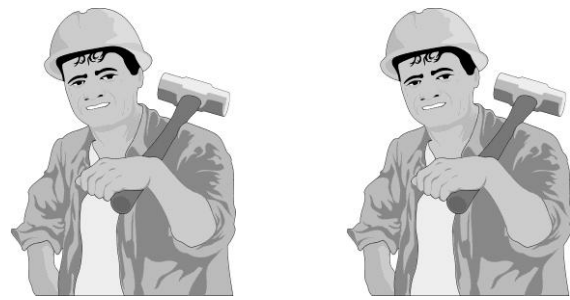

4





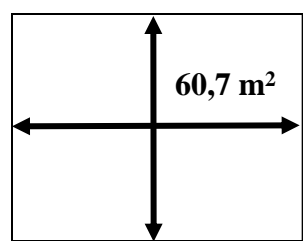

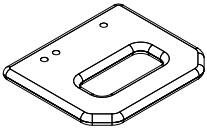

Anbefalt arealbehov ved montering / Recommended working space / Rekommenderad arealbehov vid montering

N
UK
S

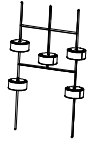
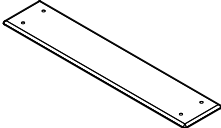

5
**Pakkliste for / Parts list for / Packlista för :
31-400-050**

Sign. _____

| N UK S | Komponenter | Dimensjon | Ant | Lev | Komponenter | Dimensjon | Ant | Lev |
|--------------|---|---|-----|-----|---|----------------|-----|-----|
| | Components | Dimension | Qty | Lev | Components | Dimension | Qty | Lev |
| S | Komponenter | Dimension | Ant | Lev | Komponenter | Dimension | Ant | Lev |
| | 00-400-170  | 172 x 200 x 15 | 7 | | 00-400-998  | 55 x 95 x 95 | 4 | |
| | | | | | 00-400-997 Med hull | | 4 | |
| | 00-400-803  | 3000 x 175 x 75 | 1 | | 00-400-150  | 940 x 120 x 40 | 2 | |
| | 00-400-805  | 3000 x 175 x 75 | 1 | | | | | |
| | 3 Hull | | | | | | | |
| | 00-400-016  | 3230 x 95x 95 | 2 | | | | | |
| | H | (N) Med HPL (UK) With HPL (S) Med HPL | | | | | | |
| | 00-400-017  | 3230 x 95x 95 | 2 | | | | | |
| | V | (N) Med HPL (UK) With HPL (S) Med HPL | | | | | | |
| | 00-104-500  | 2810 x 1330 | 1 | | | | | |
| | 00-400-102  | 1130 x 145 x 12 | 2 | | | | | |
| | Blå , Blue , Blå | | | | | | | |
| | 00-400-149  | 940 x 37 | 10 | | | | | |





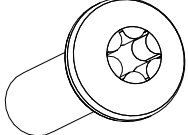
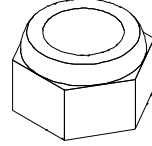
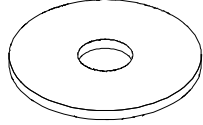









5
**Pakkliste for / Parts list for / Packlista för :
31-400-050**

Sign. _____

| N UK S | Bolter/skruer Bolts/Screws Komponenter | Dimensjon Dimension Dimension | Ant Qty Ant | Lev Lev | Bolter/skruer Bolts/Screws Bultar/Skruvar | Dimensjon Dimension Dimension | Ant Qty Ant | Lev Lev |
|--------------|---|---|--|---------------|---|---|--------------------|------------|
| | |  | 04-000-025 8 x 25 mm Torx 04-000-030 8 x 30 mm Torx 04-000-035 8 x 35 mm Torx | 19 14 8 | |  | 04-040-008 8 mm | 17 |
| |  | 04-050-008 8 mm | 14 | | | | | |
| | | | | | | | | |

Forankring / Foundations / Markförankring
00-003-003

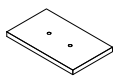
Er bestilt Ikke bestilt
 In order Not in order
 Bestått Ej bestått

| | | | | | | | | |
|----------------------|---|------------|---|--|---|-------------------------------|----|--|
| |  | 00-003-100 | | |  | 04-000-035 8 x 35 mm Torx | 12 | |
| |  | 00-003-101 | | |  | 04-050-008 8 mm | 12 | |
| |  | 00-003-102 | 4 | |  | 04-060-120 120 x 15 x 8 mm | 8 | |
| | 00-003-103 | | | |  | 04-000-040 8 x 40 mm Torx | 2 | |
| |  | | 2 | |  | 04-040-008 8 mm | 2 | |
| | | | | |  | 04-050-008 8 mm | 2 | |
| | 00-003-105 | | | |  | 04-010-035 10 x 35 mm | 0 | |
| | 00-003-106 | | | |  | 04-040-010 10 mm | 0 | |
| Eller Or Eller |  | | 0 | |  | 04-050-010 10 mm | 0 | |

6

Fundamentering med betong / Foundation concrete / Förankring med betong



(N) Bakkenivå (UK) Ground level (S) Marknivå

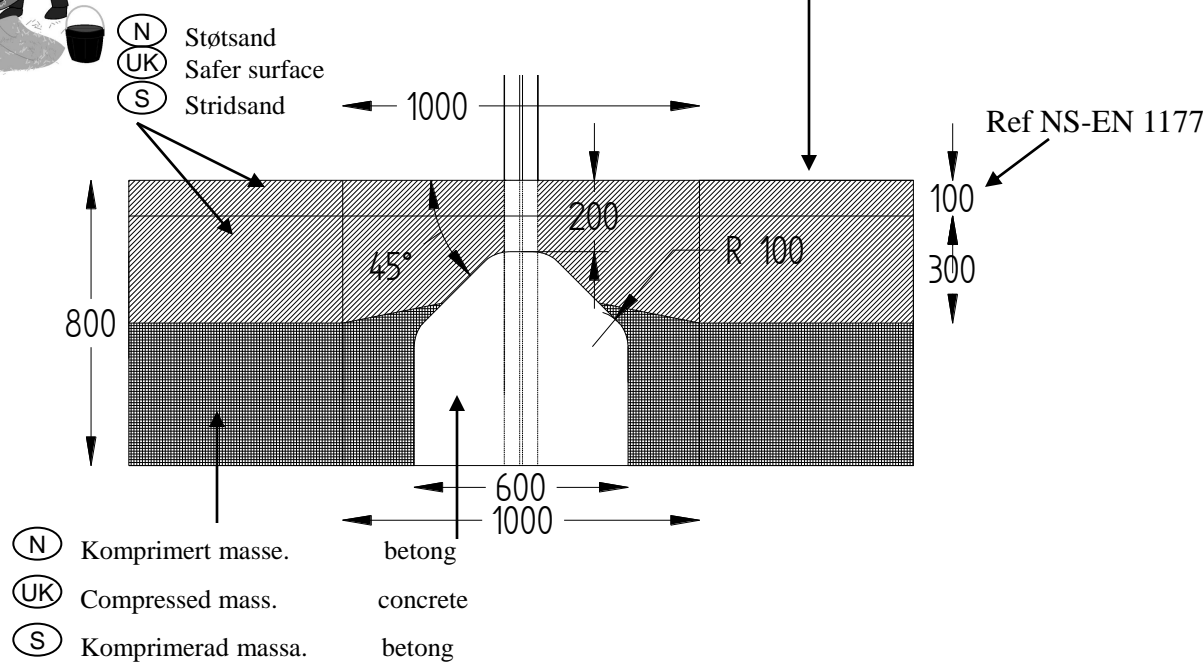

6

Fundamentering uten betong / Foundation without concrete / Förankring utan betong

(N) Bakkenivå (UK) Ground level (S) Marknivå

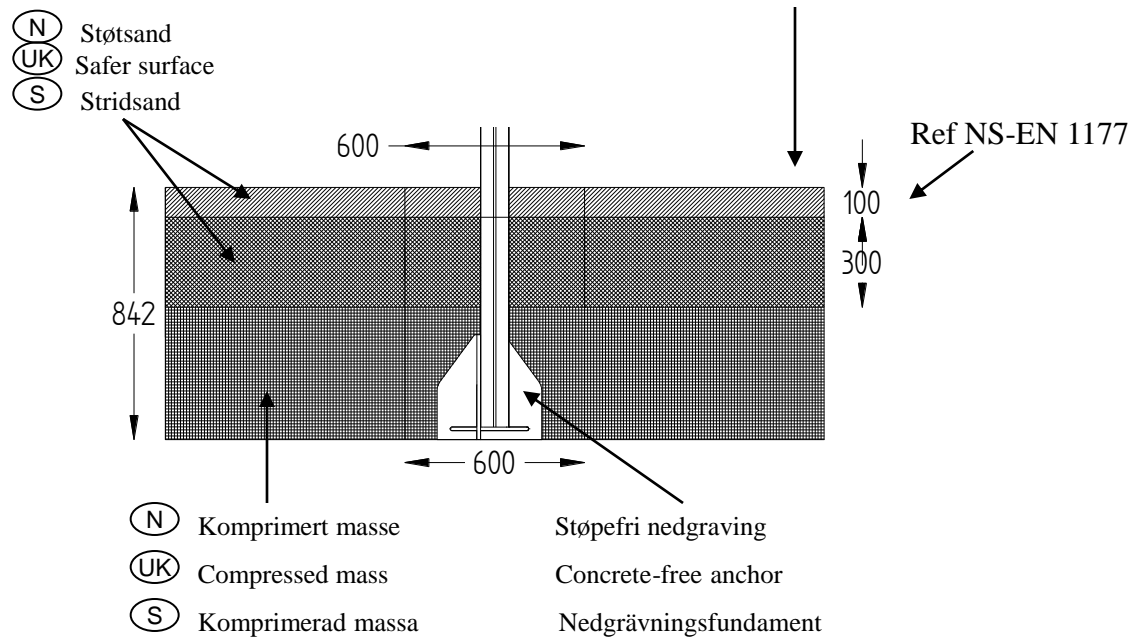

(N) Alle mål er oppgitt i millimeter

(UK) Scale measured in mm

(S) Alla mått är i millimeter.

- (N) For klatrenett
- (UK) For climbing net
- (S) För klätternät

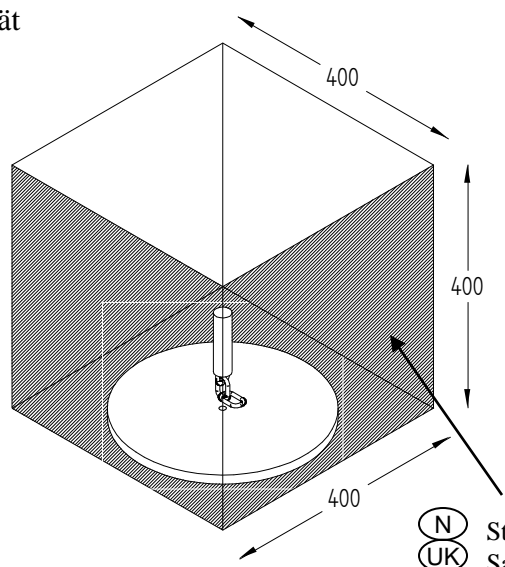
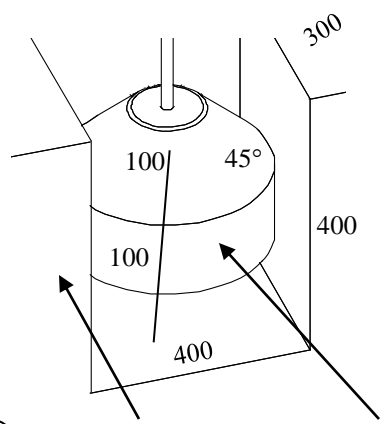

- (N) Komprimert masse. betong
- (UK) Compressed mass. concrete
- (S) Komprimerad massa. betong

- (N) Støtsand
- (UK) Safer surface
- (S) Stridsand

- (N) Alle mål er oppgitt i millimeter
- (UK) Scale measured in mm
- (S) Alla mått är i millimeter.

6

(N) Dybde for støping og forankring

(UK) Depth of foundations /

(S) Djup för gjutning och markförankring

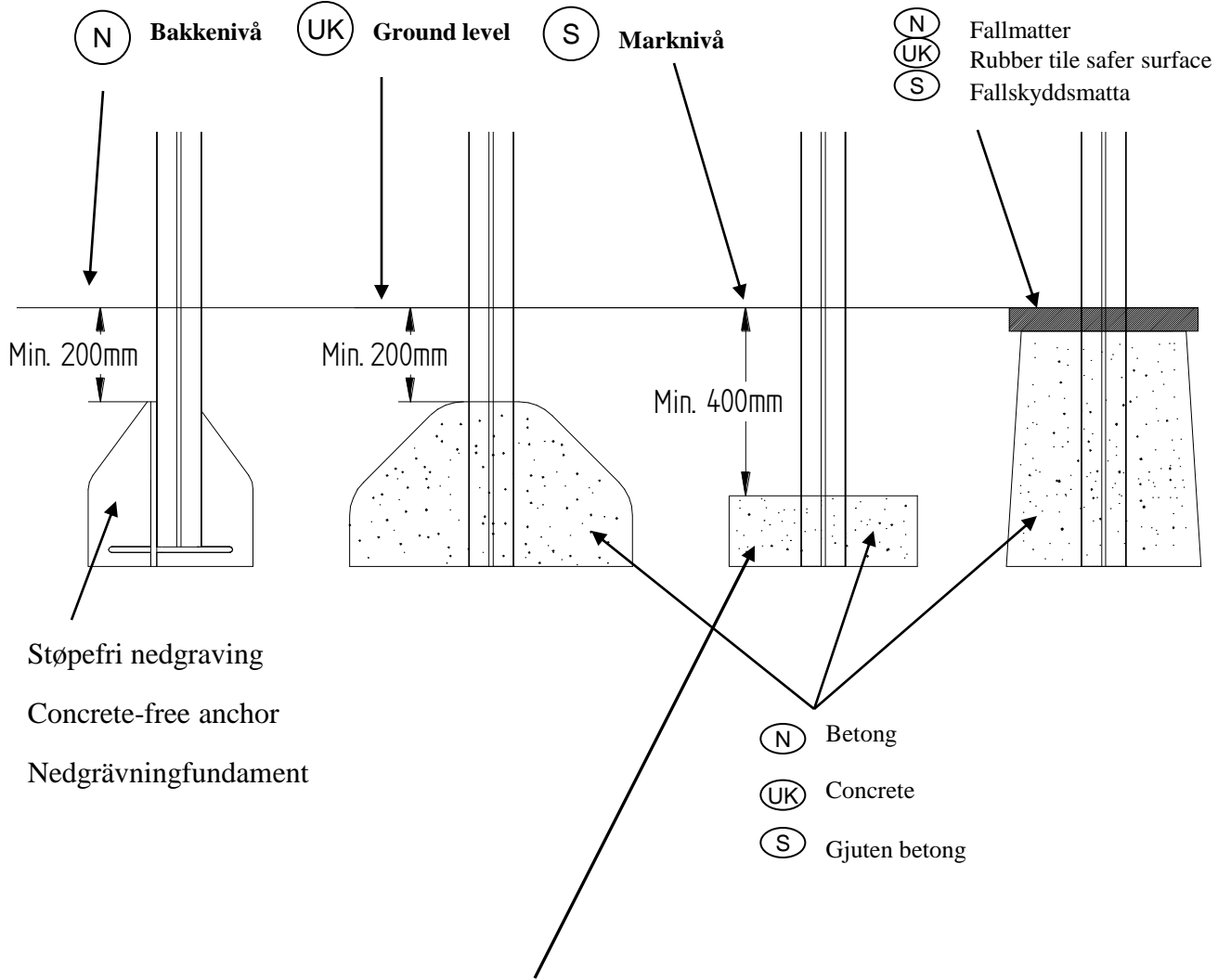

(N) Støpefri nedgraving
 (UK) Concrete-free anchor
 (S) Nedgrävningfundament

(N) Betong
 (UK) Concrete
 (S) Gjuten betong

(N) Denne støpemetoden anbefales ikke grunnet dårlig stabilitet av lekeapparatet.

(UK) This anchor is recommend not to use because of poor stability of the play unit.

(S) Denna förankring avrådes från att användas, därför att lekutrustningen får dålig fäste.

①

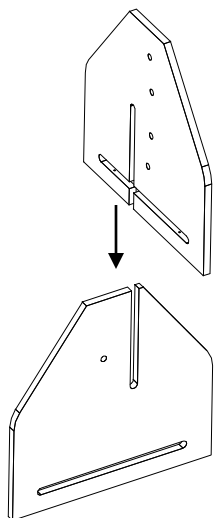

②

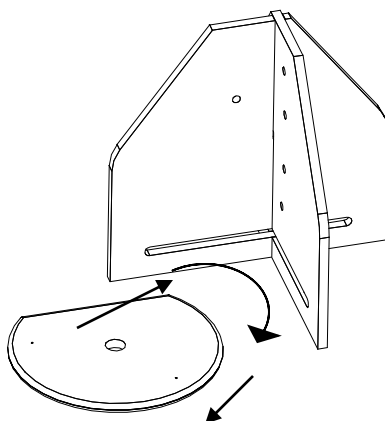

③

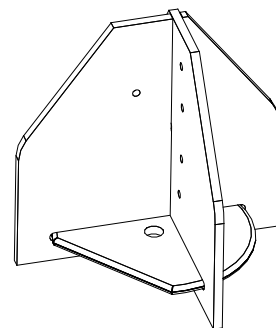

④

04-060-120 x 2
120 x 15 x 8 mm

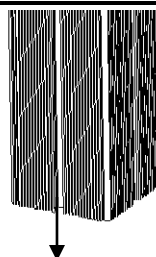

04-000-035 x 3
8 x 35 mm Torx

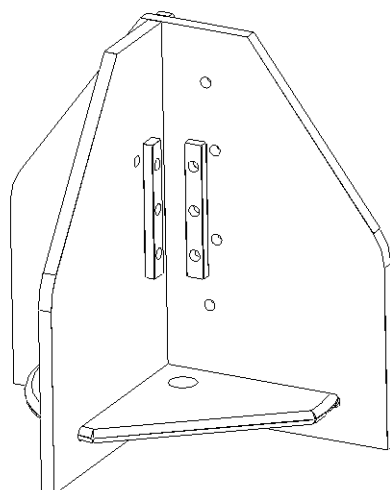

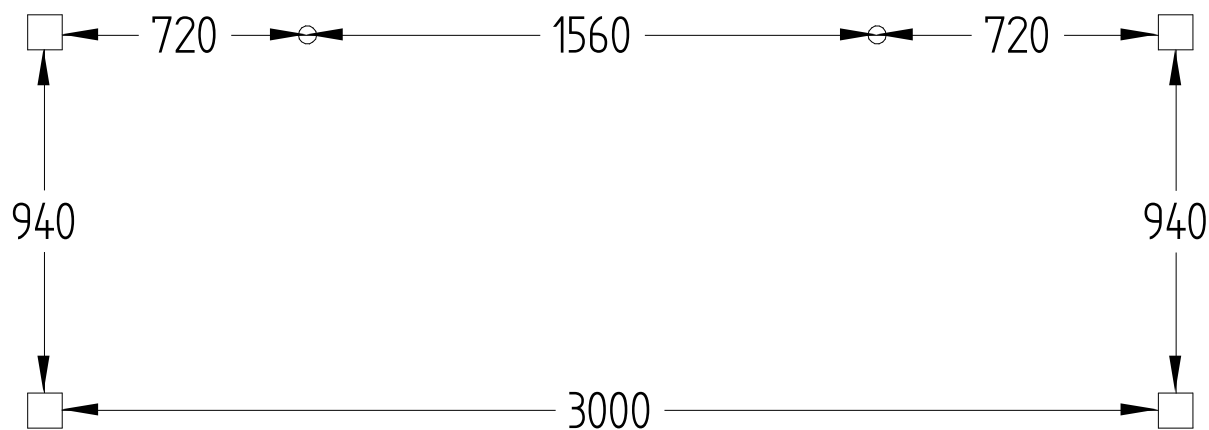

(N) Se punkt 11 for informasjon om dybde, lengde og bredde

(UK) Refer to Section 11 for dimension details of foundation holes

(S) Se punkt 11 för information om djup, längd och bredd

(N) Alle mål er oppgitt i millimeter

(UK) Scale measured in mm

(S) Alla mått är i millimeter

7

Sikkerhetssone / Safety zone / Säkerhetszon

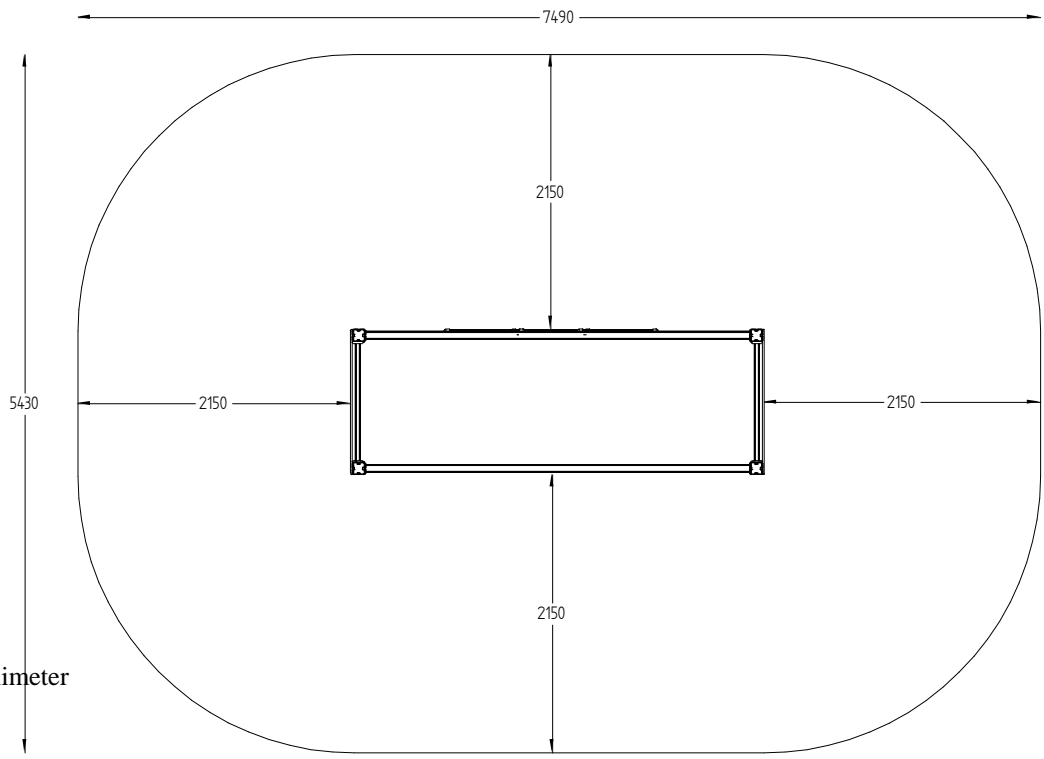

- (N) Alle mål er oppgitt i millimeter
- (UK) Scale measured in mm
- (S) Alla mått är i millimeter

8

Fallhøyder / Free height of fall / Fallhöjder

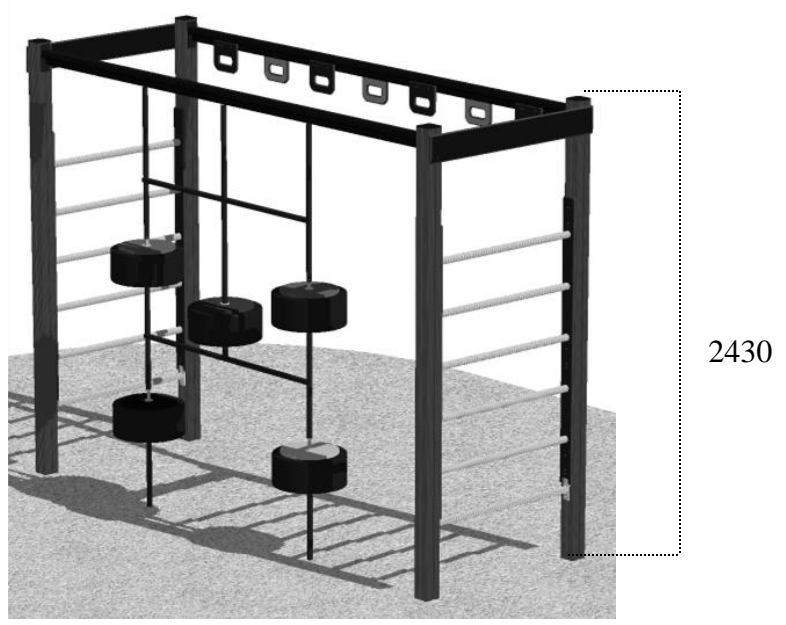

- (N) Alle mål er oppgitt i millimeter
- (UK) Scale measured in mm
- (S) Alla mått är i millimeter.

7

Sikkerhetssone / Safety zone / Säkerhetszon

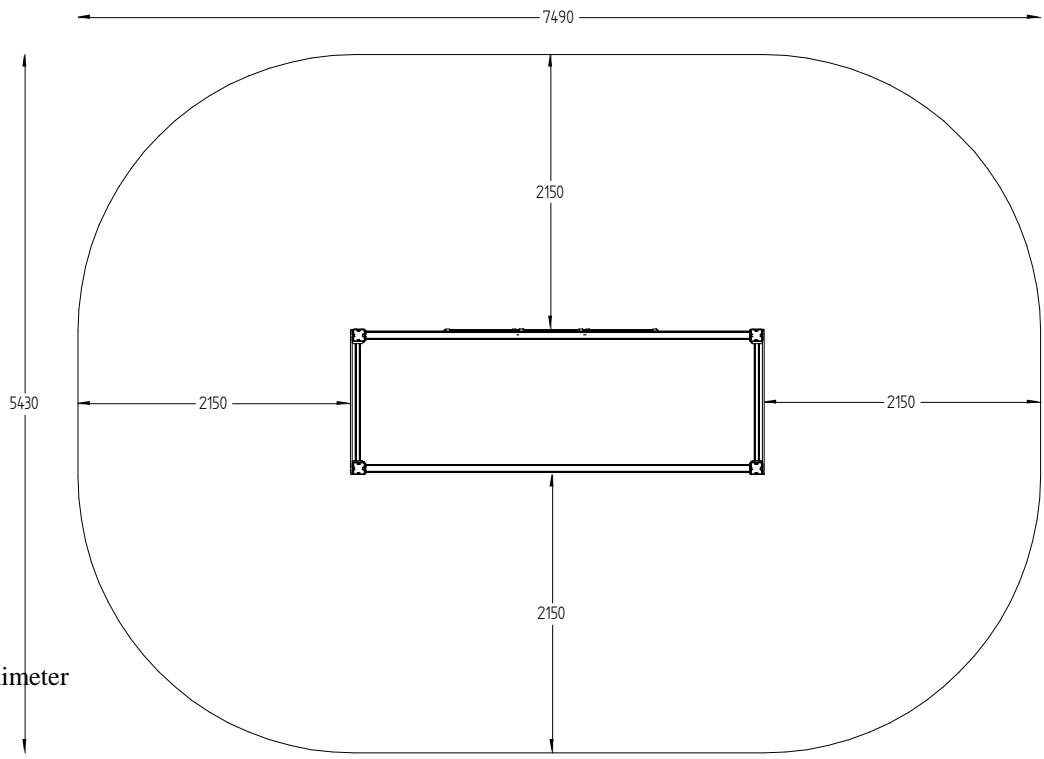

- (N) Alle mål er oppgitt i millimeter
- (UK) Scale measured in mm
- (S) Alla mått är i millimeter

8

Fallhøyder / Free height of fall / Fallhöjder

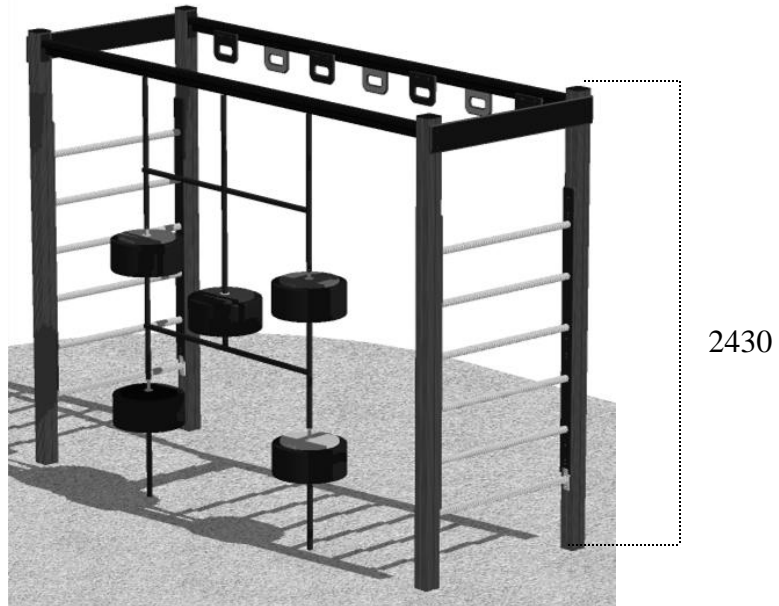

- (N) Alle mål er oppgitt i millimeter
- (UK) Scale measured in mm
- (S) Alla mått är i millimeter.

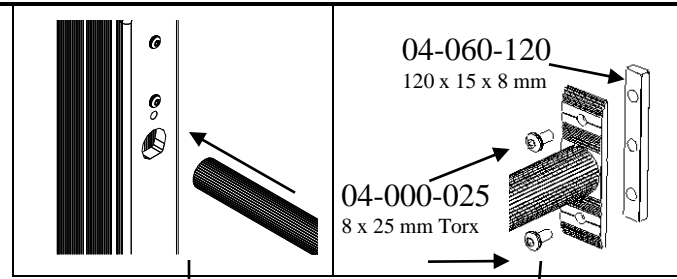
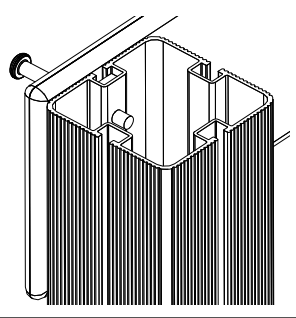

(N) Med bruk av betong
 (UK) With use of concrete
 (S) Med bruk av betong

00-400-997



00-400-017

1



00-400-016

00-400-149 x 5

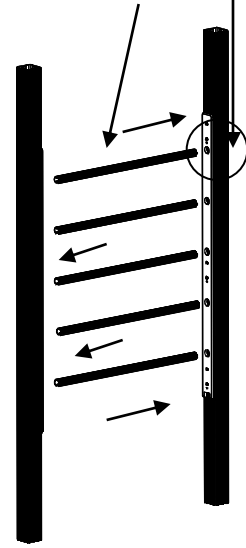

2



00-400-150

3

00-400-102

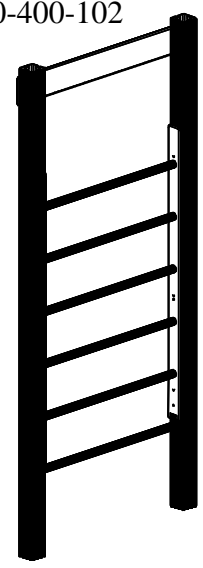

00-400-102

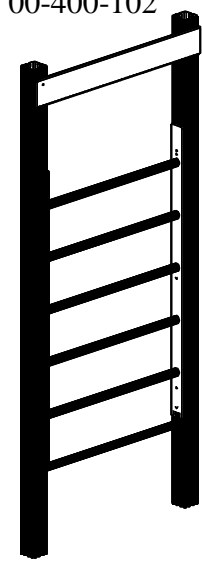

1

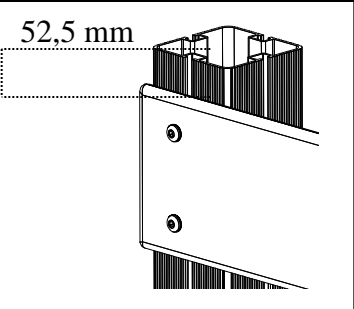
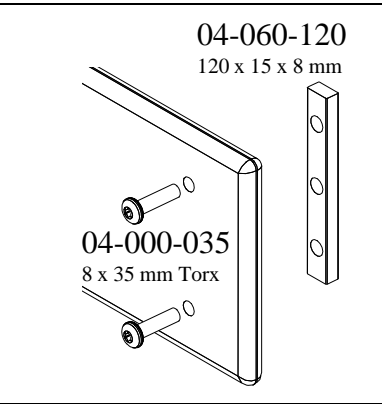

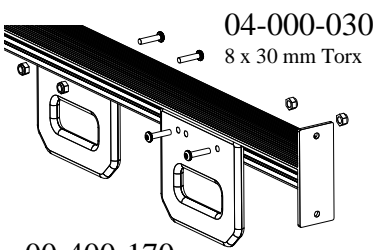
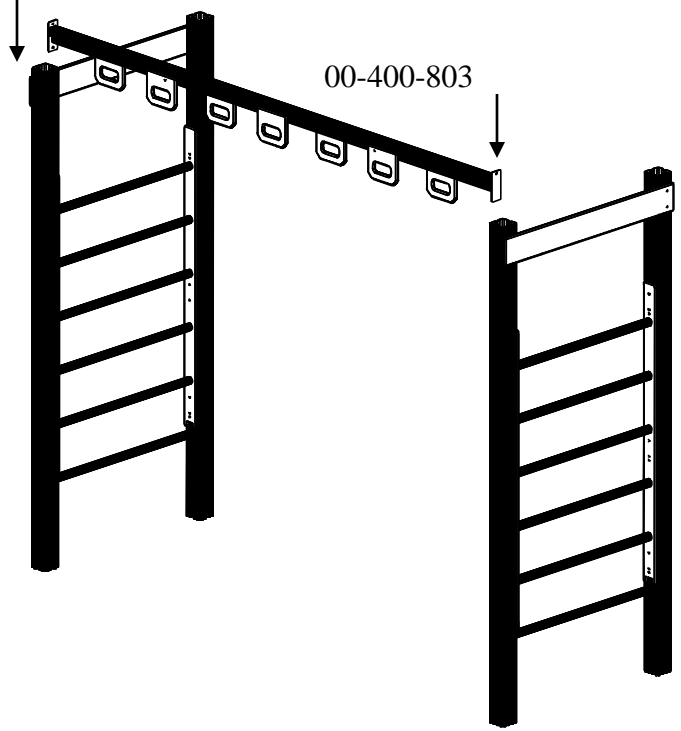
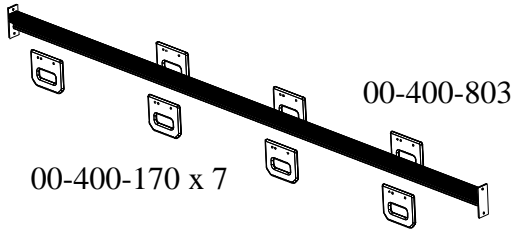

00-400-170

04-000-025
8 x 25 mm Torx

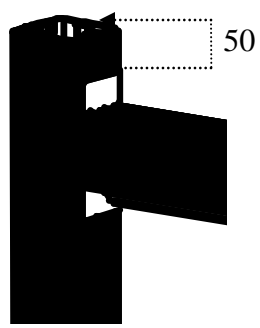
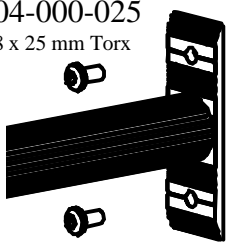

2

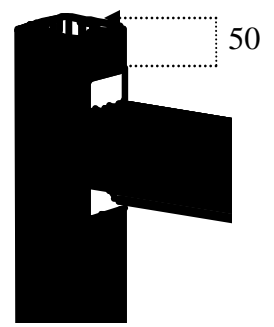
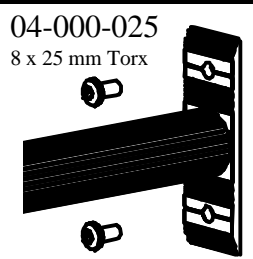
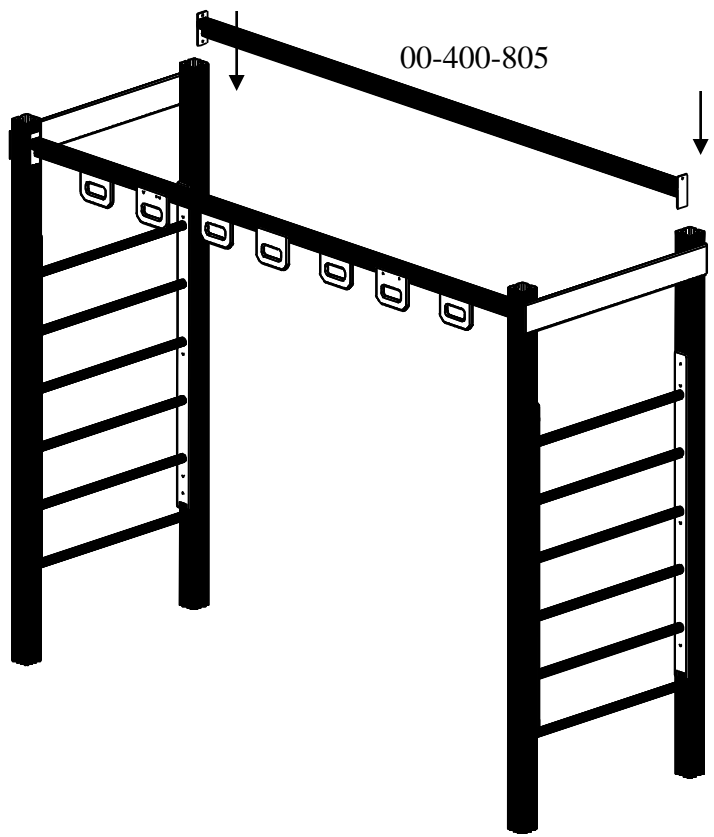

3

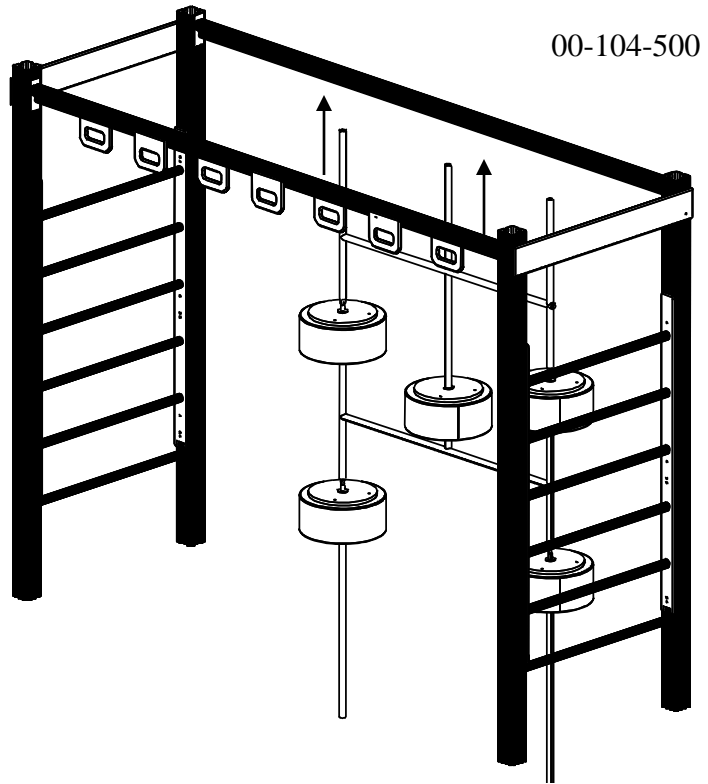
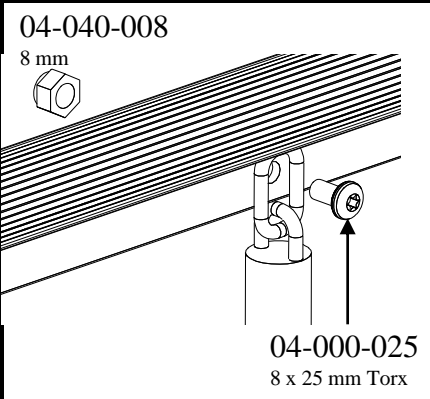

4

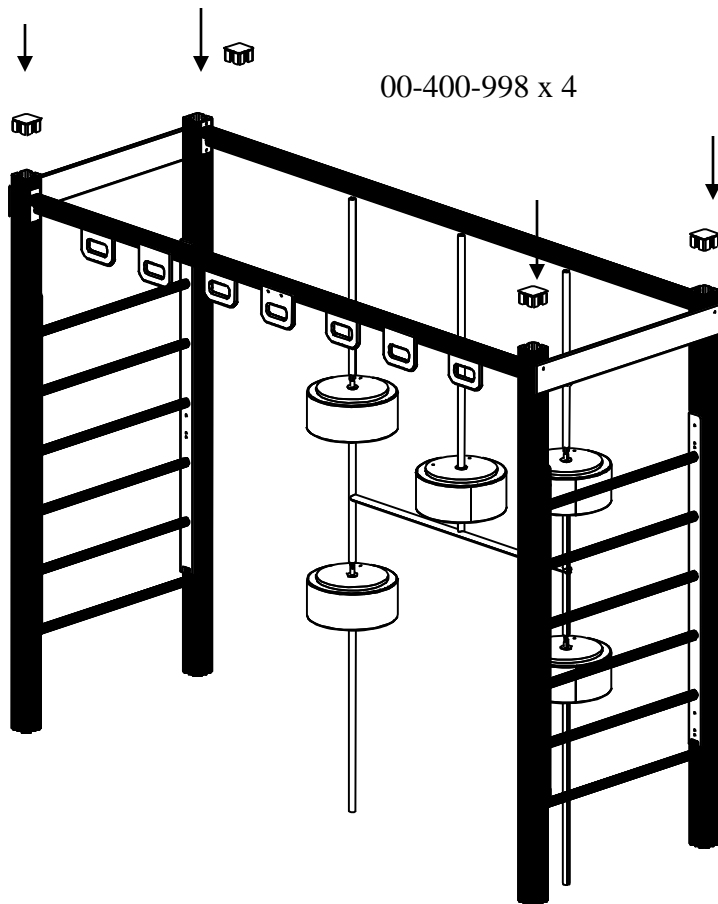

5

N

- ▣ Påse at fallunderlag er lagt i henhold til gjeldende regler eller vår anbefaling
- ▣ Fjern alle monteringshjelpemidler (rester av betong, planker, paller, plast, og lignende)
- ▣ Før utstyret tas i bruk, sjekk at det ikke er hektefare for anorakksnorer og lignende noen steder på lekeapparatet.

NB! Bør stå i 2-3 dager før bruk når forankring støpes.

UK

- ▣ Make sure the area and depth of safer surfacing are according to the current standard, or to the manufacturer's recommendation
- ▣ Make sure all tools and surplus materials are removed before play begins

PS! When complete, allow 2-3 days for the concrete to set before use.







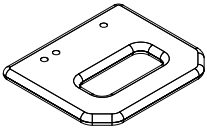

S

- ▣ Kontrollera att fallunderlag är utlagt enligt gällande regler eller vår rekommendation
- ▣ Ta bort alla monteringshjälpmedel (rester av betong, plankor, pallar, plast och liknande)
- ▣ Innan lekredskapet används, kontrollera att anoracksnoddar eller kläder/delar av kläder eller liknande inte kan fastna i några delar på redskapet.

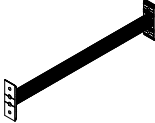
- ▣ OBS! Bör stå i 2-3 dagar innan användning när det gjuts

5
**Pakkliste for / Parts list for / Packlista för :
31-400-050**

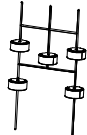
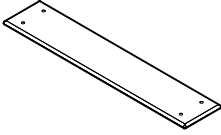
Sign. _____

| N UK S | Komponenter | Dimensjon | Ant | Lev | Komponenter | Dimensjon | Ant | Lev |
|--------------|---|--|-----|-----|---|----------------|-----|-----|
| | Components | Dimension | Qty | Lev | Components | Dimension | Qty | Lev |
| S | Komponenter | Dimension | Ant | Lev | Komponenter | Dimension | Ant | Lev |
| | 00-400-170  | 172 x 200 x 15 | 7 | | 00-400-998  | 55 x 95 x 95 | 4 | |
| | | | | | 00-400-997 Med hull | | 4 | |
| | 00-400-803  | 3000 x 175 x 75 | 1 | | 00-400-150  | 940 x 120 x 40 | 2 | |
| | 00-400-805  | 3000 x 175 x 75 | 1 | | | | | |
| | 3 Hull | | | | | | | |
| | 00-400-016  H | 3230 x 95x 95 N Med HPL UK With HPL S Med HPL | 2 | | | | | |
| | 00-400-017  V | 3230 x 95x 95 N Med HPL UK With HPL S Med HPL | 2 | | | | | |
| | 00-104-500  | 2810 x 1330 | 1 | | | | | |
| | 00-400-102  | 1130 x 145 x 12 Blå , Blue , Blå | 2 | | | | | |
| | 00-400-149  | 940 x 37 | 10 | | | | | |

5





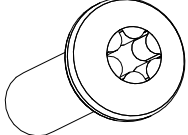
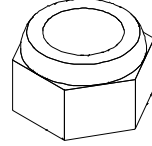
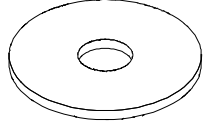









**Pakkliste for / Parts list for / Packlista för :
31-400-050**

Sign. _____

| N UK S | Bolter/skruer Bolts/Screws Komponenter | Dimensjon Dimension Dimension | Ant Qty Ant | Lev Lev | Bolter/skruer Bolts/Screws Bultar/Skruvar | Dimensjon Dimension Dimension | Ant Qty Ant | Lev Lev |
|--------------|---|---|--|---------------|---|---|--------------------|------------|
| | |  | 04-000-025 8 x 25 mm Torx 04-000-030 8 x 30 mm Torx 04-000-035 8 x 35 mm Torx | 19 14 8 | |  | 04-040-008 8 mm | 17 |
| |  | 04-050-008 8 mm | 14 | | | | | |
| | | | | | | | | |

Forankring / Foundations / Markförankring
00-003-003

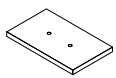
Er bestilt Ikke bestilt
 In order Not in order
 Bestått Ej bestått

| | | | | | | | | |
|----------------------|---|------------|---|--|---|-------------------------------|----|--|
| |  | 00-003-100 | | |  | 04-000-035 8 x 35 mm Torx | 12 | |
| |  | 00-003-101 | | |  | 04-050-008 8 mm | 12 | |
| |  | 00-003-102 | 4 | |  | 04-060-120 120 x 15 x 8 mm | 8 | |
| | 00-003-103 | | | |  | 04-000-040 8 x 40 mm Torx | 2 | |
| |  | | 2 | |  | 04-040-008 8 mm | 2 | |
| | | | | |  | 04-050-008 8 mm | 2 | |
| | 00-003-105 | | | |  | 04-010-035 10 x 35 mm | 0 | |
| | 00-003-106 | | | |  | 04-040-010 10 mm | 0 | |
| Eller Or Eller |  | | 0 | |  | 04-050-010 10 mm | 0 | |