

N

Monteringsanvisning

EN

Assembly Instructions

S

Monteringsanvisning

Produkt nr. / Product no. / Produkt nr.

31-400-060**Sort/ gul**

Ord. nr. _____

Dato. _____

Sign. _____

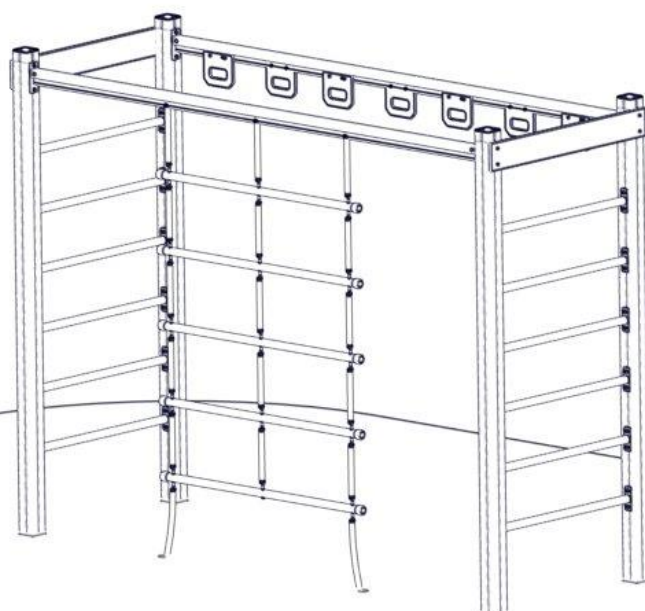
**søve**

Søve AS
 Grønnvoldveien 290
 3830 Ulefoss - Norway
 Tlf: +47 35 94 65 65
www.sove.no

**søve**

Søve AB
 EA Rosengrensgatan 32
 421 31 Västra Frölunda
 Phone: +46 (0)31 773 97 00
www.sove.se

Monteringstips / Assembly Advice / Monteringsstips

N

- Les monteringsanvisningen nøye før montering.

- Monter elementene i rekkefølgen som vist.
- Boltene bør ikke skrues for hardt til før alt er montert, vatret og loddet. Skru så boltene til.
- NB! Ved bruk av drill, kan boltene ryke.
- På grunn av at solen kan gjøre rutsjeflaten veldig varm, bør rutsjebanens utløp vende mot nord-øst eller nord-vest.
- Er lekeutstyret plassert i naturlige ferdselstraséer må området sikres mot gjennomgang.
- Innspringningshinder bør vurderes rundt lekeapparater hvor det er stor bevegelse, f.eks. ved huskestativ.
- Det bør være fritt innsyn til lekeutstyr som er beregnet for barn under 3 år.

NB! Under monteringsarbeidet må utstyr, som ikke er forankret forsvarlig i bakken, sikres slik at det ikke velte.

Området må avstenges under montering av apparatene med sperrebånd eller lignende.

EN

- Read the instruction carefully before assembling the play unit.

- Assemble the components in the sequence shown in these instructions. Fixings must not be fully tightened during assembly. Before casting the foundations, the structure must be level and plumb, at which point all fixings are tightened. PS! If use of drill, the bolts may be wrecked.
- Avoid positioning the slide facing due south because of overheating – ideal positions are facing north-east or north-west. Secure the construction-area to prevent people from walking through it.
- Consider installing barriers around play-equipment which gives rise to a lot of activity – i.e. swings.
- Ensure that clear vision is possible across the play area so that supervision is possible from any position, particularly where children under 3 years of age will be playing.

NB! During assembly of the equipment, ensure that all structures are securely propped, especially when left overnight. Also ensure that equipment is supported

Monteringstips / Assembly Advice / Monteringsstips**S**

- Läs monteringsanvisningen noga före montering.

- Montera delarna i den ordningen som anvisas
- Skruvarna bör inte skruvas för hårt tills allt är monterat, i våg och lodat.

OBS! Används elektrisk skruvdragare, kan bulten gå sönder. Hårdra därför manuellt!

- Solen kan göra att rutchbanan blir väldigt varm. Banans nedfart rekommenderas att vändas i norrlig riktning
- Om lekplatsen placeras vid en gångväg mm bör området säkras mot genomfart av gående och cyklister.
- Insprängningshinder bör placeras runt lekutrustning med stor rörelse, t ex, gungställning.
- Det bör vara fri insyn till lekutrustning beräknat till barn under 3 år.

OBS! Under monteringsarbete bör utrustningen som inte ska förankras i marken, ställs så att den inte kan välta.

Området måste spärras när lekutrustningen byggs upp, med avspärrningsband eller liknande.

Fundamentering med betong / Foundation concrete / Förankring med betong

- (N) Støtdempende materialer
- (EN) Impact attenuating materials
- (S) Støtdämpande material

Ref
NS-EN 1176-1
§4.2.8.5

- (N) Bakkenivå
- (EN) Ground level
- (S) Marknivå

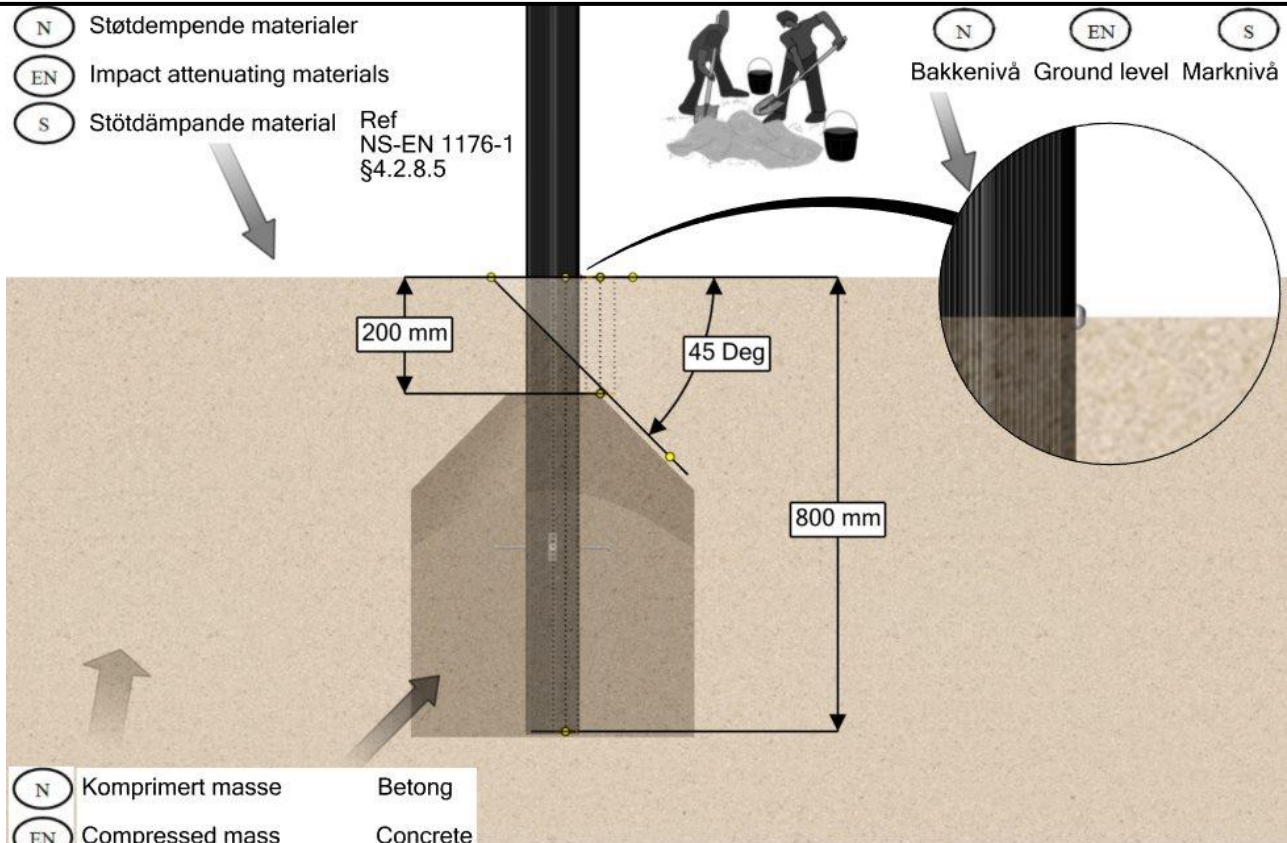

- (N) Komprimert masse Betong
- (EN) Compressed mass Concrete
- (S) Komprimerad massa Betong

Fundamentering uten betong / Foundation without concrete / Förankring utan betong

- (N) Støtdempende materialer Ref
NS-EN 1176-1
- (EN) Impact attenuating materials §4.2.8.5
- (S) Støtdämpande material

- (N) Bakkenivå
- (EN) Ground level
- (S) Marknivå

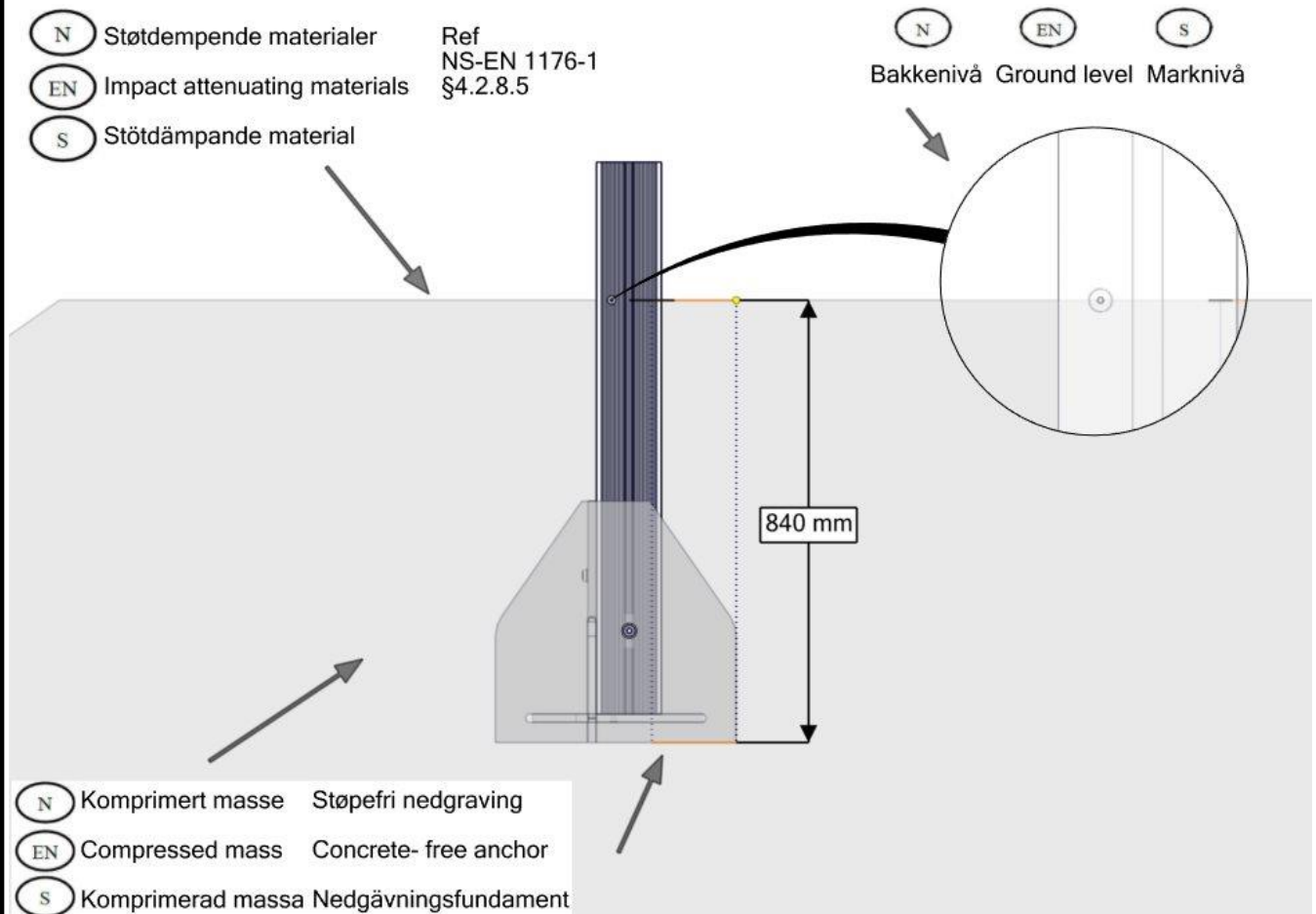







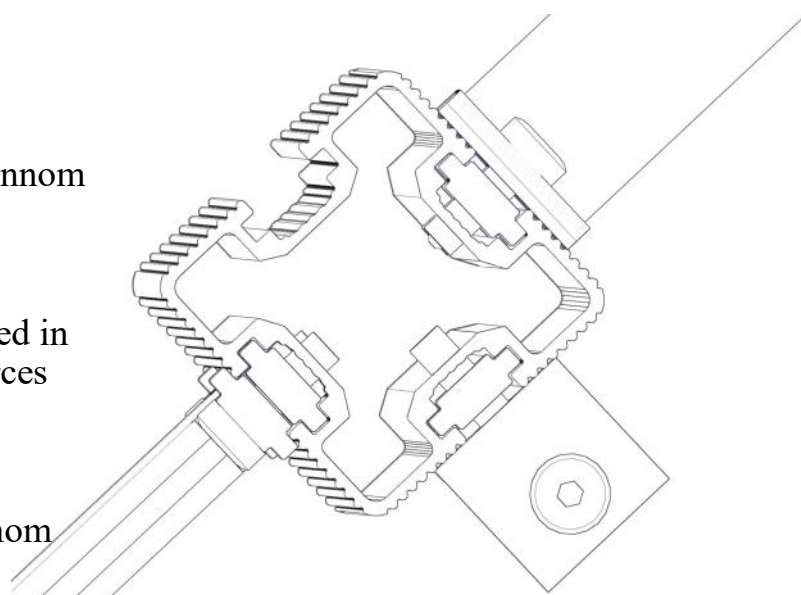



- (N) Komprimert masse Støpefri nedgraving
- (EN) Compressed mass Concrete-free anchor
- (S) Komprimerad massa Nedgävningsfundament

Fundamentering med betong / Foundation concrete / Förankring med betong

- (N) Bolten skrues HELT igjennom aluminiumen.
Maks moment: 30Nm
- (EN) The bolt must be tightened in to the post, so that it pierces the aluminium
Max torque: 30Nm
- (S) Bulten skruvas HELT genom aluminiumen.
Maks vridmoment: 30Nm



Nødvendig verktøy / Tools required / Nödvändiga verktyg

<p>(N)</p> <p>(EN)</p> <p>(S)</p>	<p>(A)</p> 	<p>(B)</p>  <p>Torx Nr 45</p>	<p>(C)</p> <p>5 mm 6 mm</p> 	<p>(D)</p> 	<p>(E)</p> 
		<p>Metermål Metric measure Tumstock</p> 	<p>Ø11mm Bor Ø11mm Drill Ø11mm Borr</p> 	<p>Merkebånd Mark ribbon Märkeband</p> 	<p>13 + 17mm</p> 

Nødvendig antall personer / Number of persons required / Rekommenderad antal personer



Anbefalt arealbehov ved montering / Recommended working space / Rekommenderad arealbehov vid montering

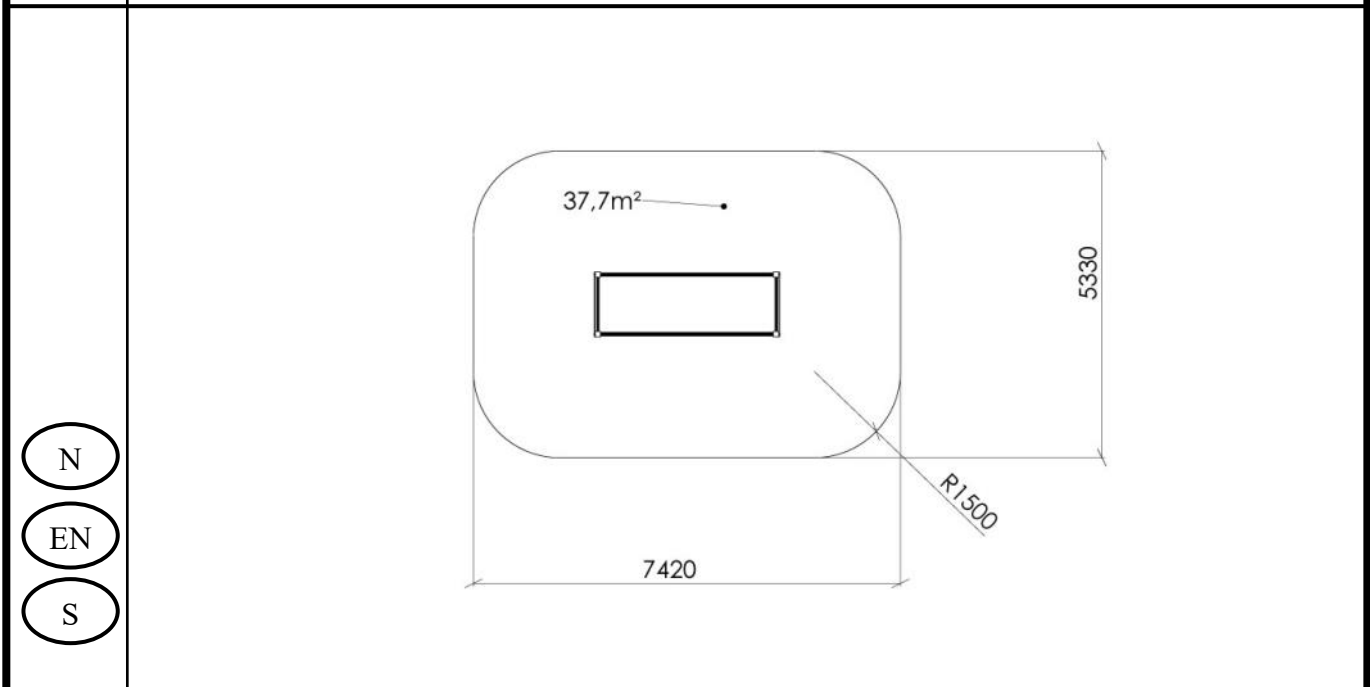

NO	Betongkvalitet	C25/30		
SE	Betongkvalitet			
EN	Concrete quality			
NO	Mengde betong		0,5	m ³
SE	Mängd betong			
EN	Amount of concrete			
NO	Fundament størrelse		0,5 x 0,5 x 0,4	m
SE	Stiftelsestorlek			
EN	Foundation size			
NO	For sikkerhet må fundamentene med sand eller myk jord være minst 50% større i areal			
SE	För säkerheten måste grunden med sand eller mjuk jord vara minst 50% större i området			
EN	For safety, the foundations with sand or soft soil must be at least 50% larger in area			
NO	Tyngste element	SFA5117/1	10,5	Kg
SE	Tyngsta element			
EN	Heaviest element			
NO	Største element	SFA5117/1	3,23x0,095x0,095	m
SE	Största element			
EN	Biggest element			

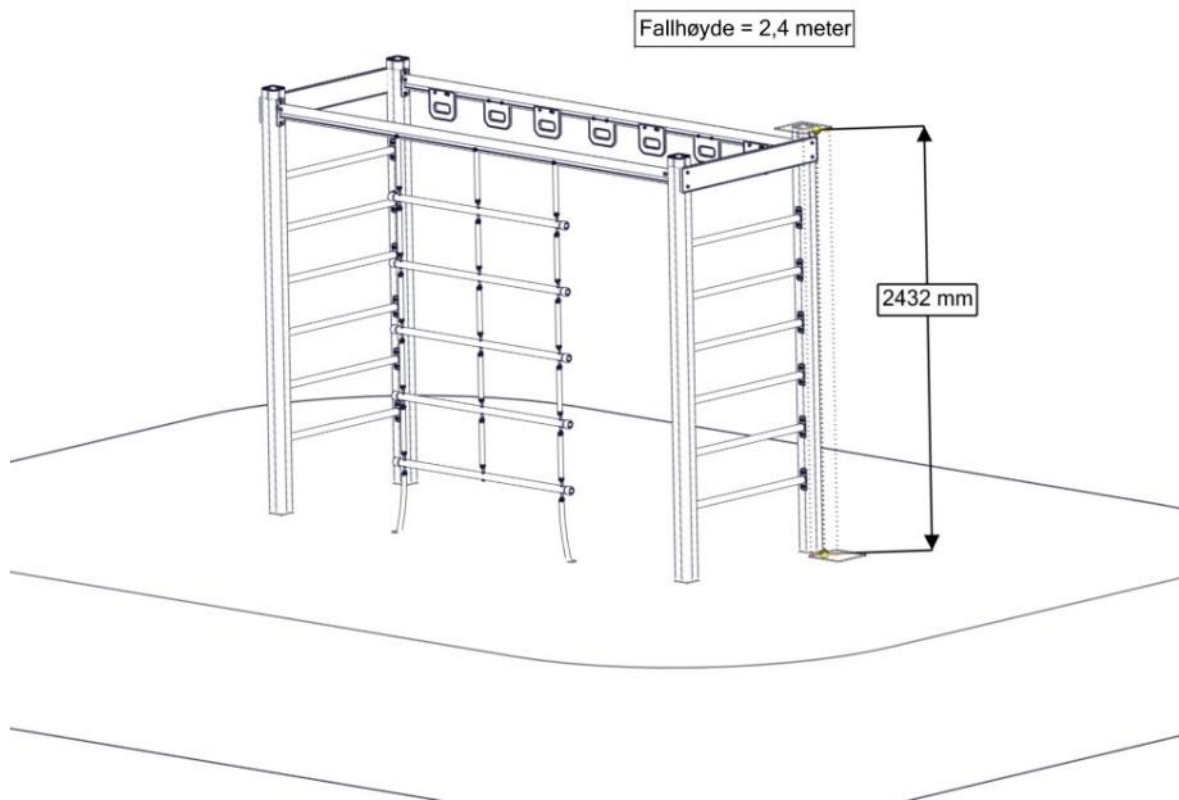
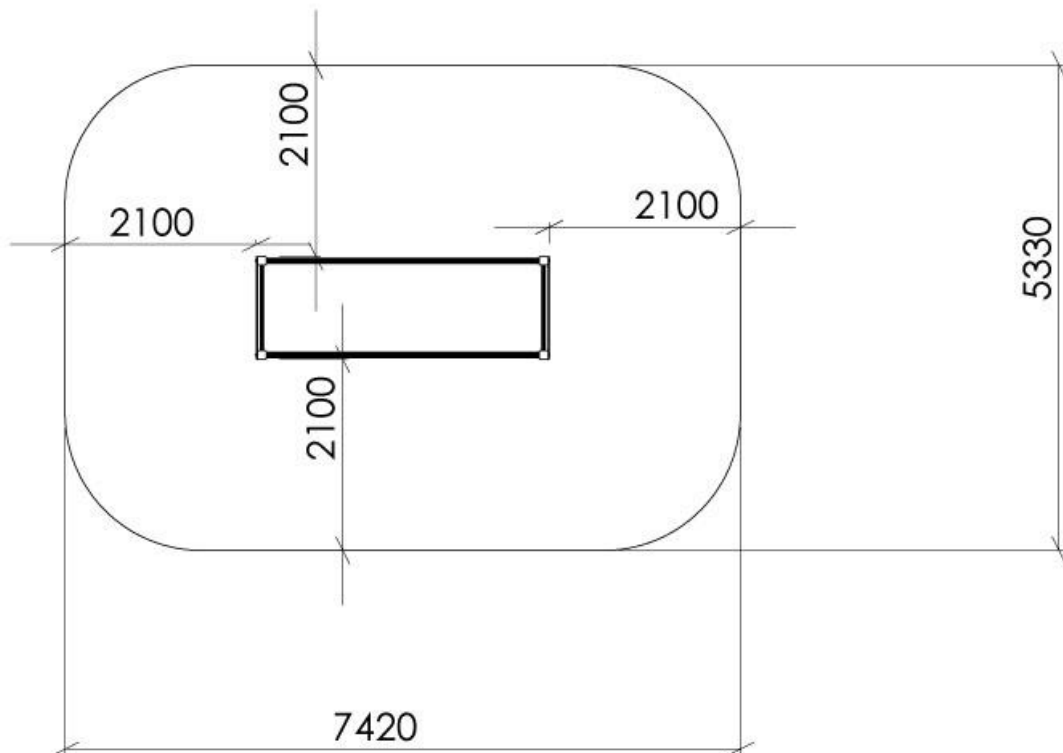
Fallhøyder / Free height of fall / Fallhöjder**Sikkerhetszone / Safety zone / Säkerhetszon**

Plassering av forankringer / Ground plan / Placering av förankringar

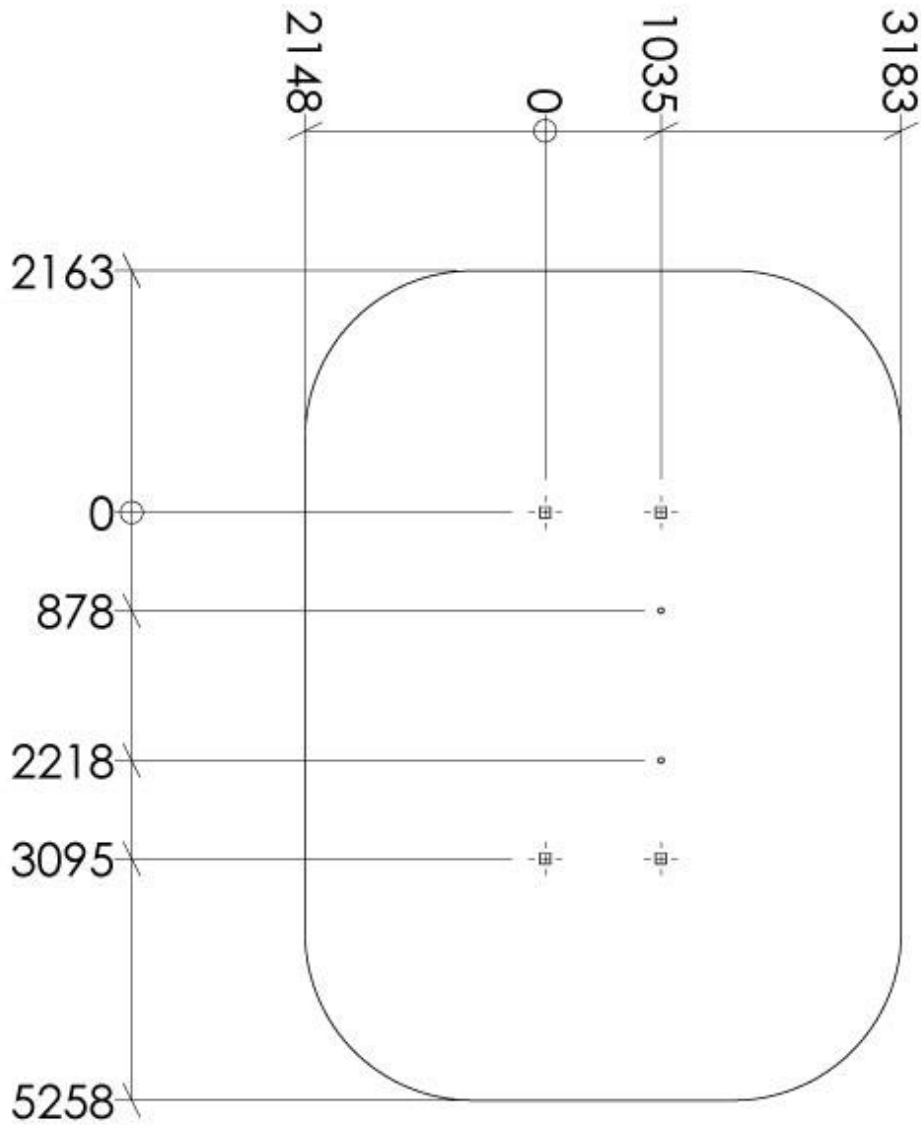

N

Alle mål er oppgitt i millimeter

EN







Scale measured in mm

S

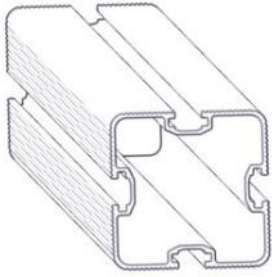
Alla mått är i millimeter.







Boltepakker for / Boltpackage for / Bultpaket för



Sign. _____.

Ekornet Sort/Gul 31-400-060	Navn	Artnr/ dimensjon	Ant	Lev
	Stolpe 95x95 L= 3230 (800-2430) Sort	SFA5117/1	4	
	Sperrerør STD L=940 Gul	00-400-150K (se egen del- montering)	12	
	Endelokk 95x95 Sort	00-400-998	4	
	Sprosse HPL standard Sort	00-400-103K (se egen del- montering)	2	
	Drager L=3000 for 7 handtak Sort	00-400-818K (se egen del- montering)	1	
	Alu profil Rype I, L=3000 3 hull cc 600 Sort	00-400-823K (se egen del- montering)	1	

Boltepakker for / Boltpackage for / Bultpaket för

Sign. _____.

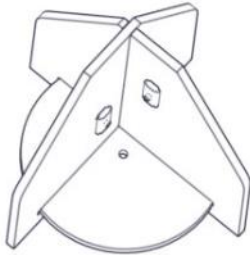
Ekornet Sort/Gul 31-400-060	Navn	Artnr/ dimensjon	Ant	Lev
	Produktmerke	00-100-401 (Montert hos Søve)	0	
	AE- nett kjetting med sperreør Rød/Gul	05-103-022K (se egen del- montering)	1	
	Håndtak HPL Rød Håndtak HPL, Gul	00-400-177 00-400-176	3 4	
	Torx M8x30	04-000-030	14	
	Låsemutter M8	04-040-008	14	
	Plastpropp 13mm hode 9-11	04-090-002	7	

Boltepakker for / Boltpackage for / Bultpaket för		Sign. _____.		
Ekornet Sort/Gul 31-400-060	Navn	Artnr/ dimensjon	Ant	Lev
	<u>For nedgraving</u>			
	Nedgravingsfundament 95x95	00-003-004K (se egen del- montering)	4	
	<u>For støping</u>			
	Støpe fundament	00-003-110K	4	

Montering av lekeapparatet / Assembly instructions / Montering av lekredskapet

Se separat delmontering for detaljer
 See separate assembly for details
 Se separata delmontering för detaljer

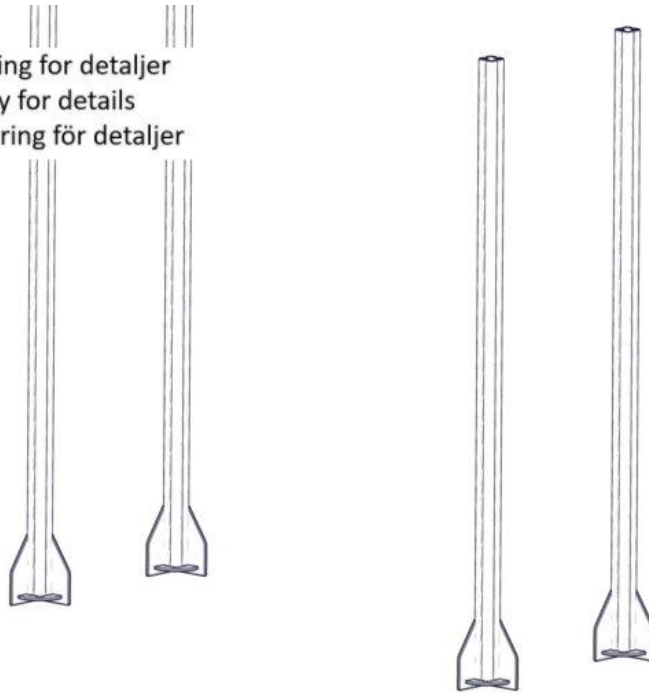

Part Name	Article nr.	Qty
Stolpe 95x95 L=3230	SFA5117/1	4
Nedgravingsfundament 95x95	00-003-004K	4

Se separat delmontering for detaljer
 See separate assembly for details
 Se separata delmontering för detaljer

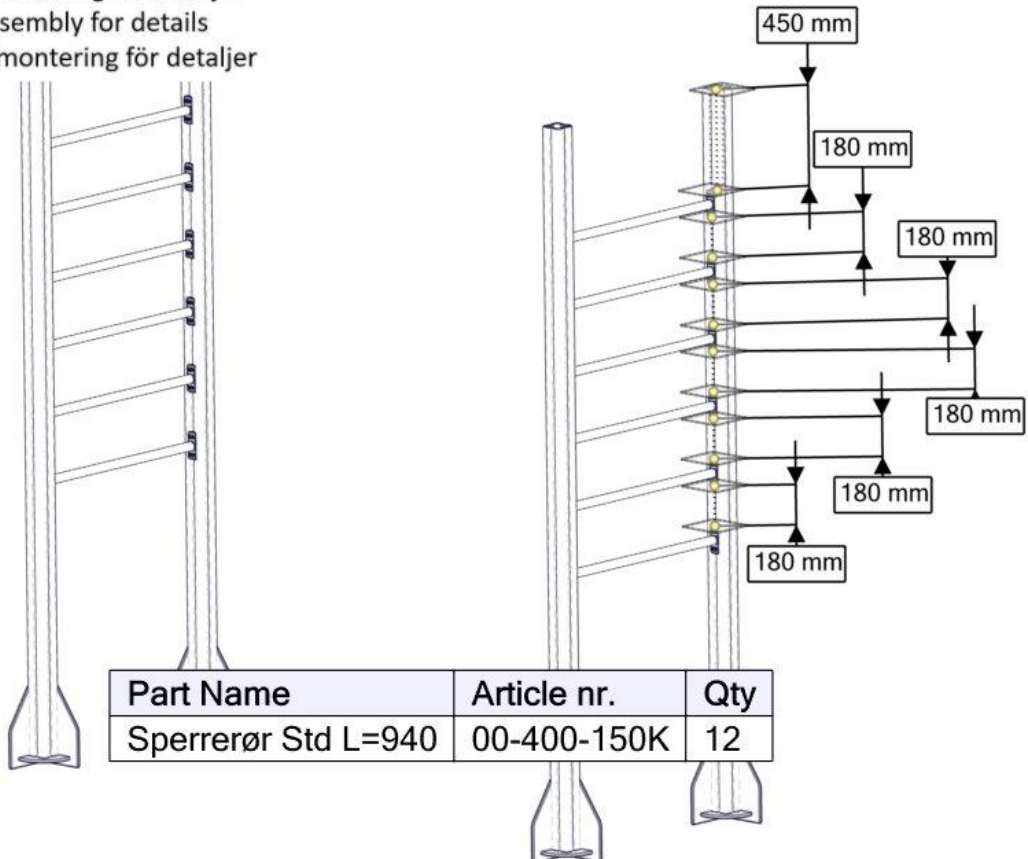

Part Name	Article nr.	Qty
Sperrerør Std L=940	00-400-150K	12

Montering av lekeapparatet / Assembly instructions / Montering av lekredskapet

Se separat delmontering for detaljer
 See separate assembly for details
 Se separata delmontering för detaljer

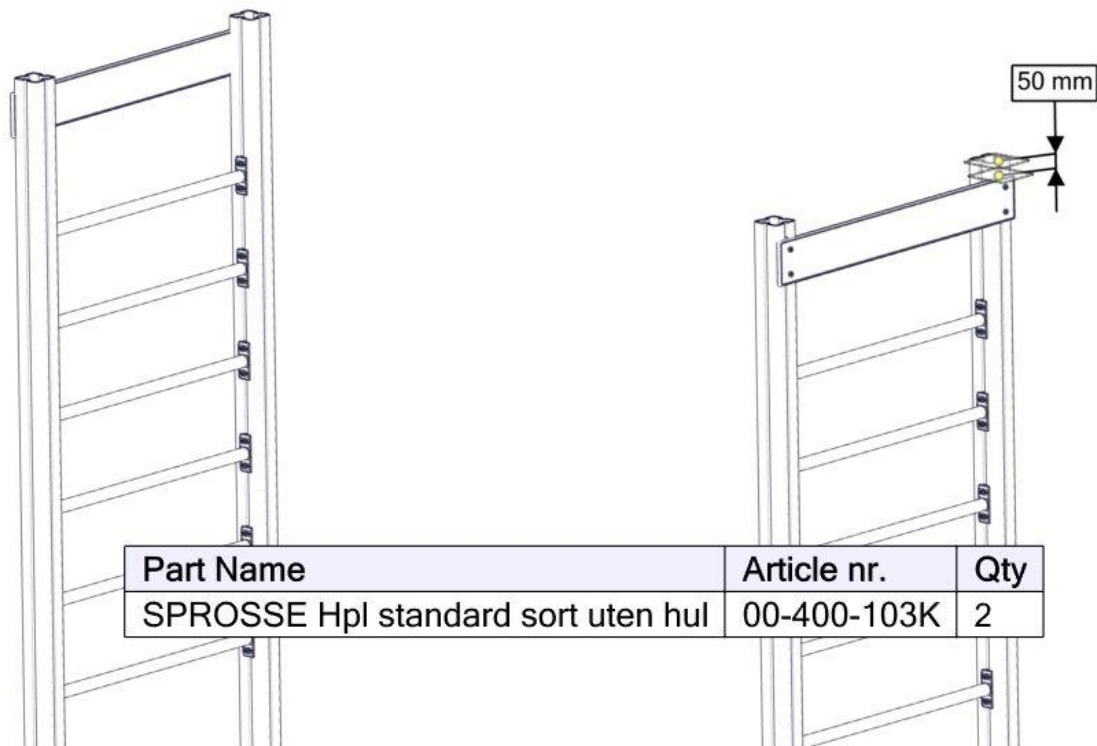

Part Name	Article nr.	Qty
SPROSSE Hpl standard sort uten hul	00-400-103K	2

Se separat delmontering for detaljer
 See separate assembly for details
 Se separata delmontering för detaljer

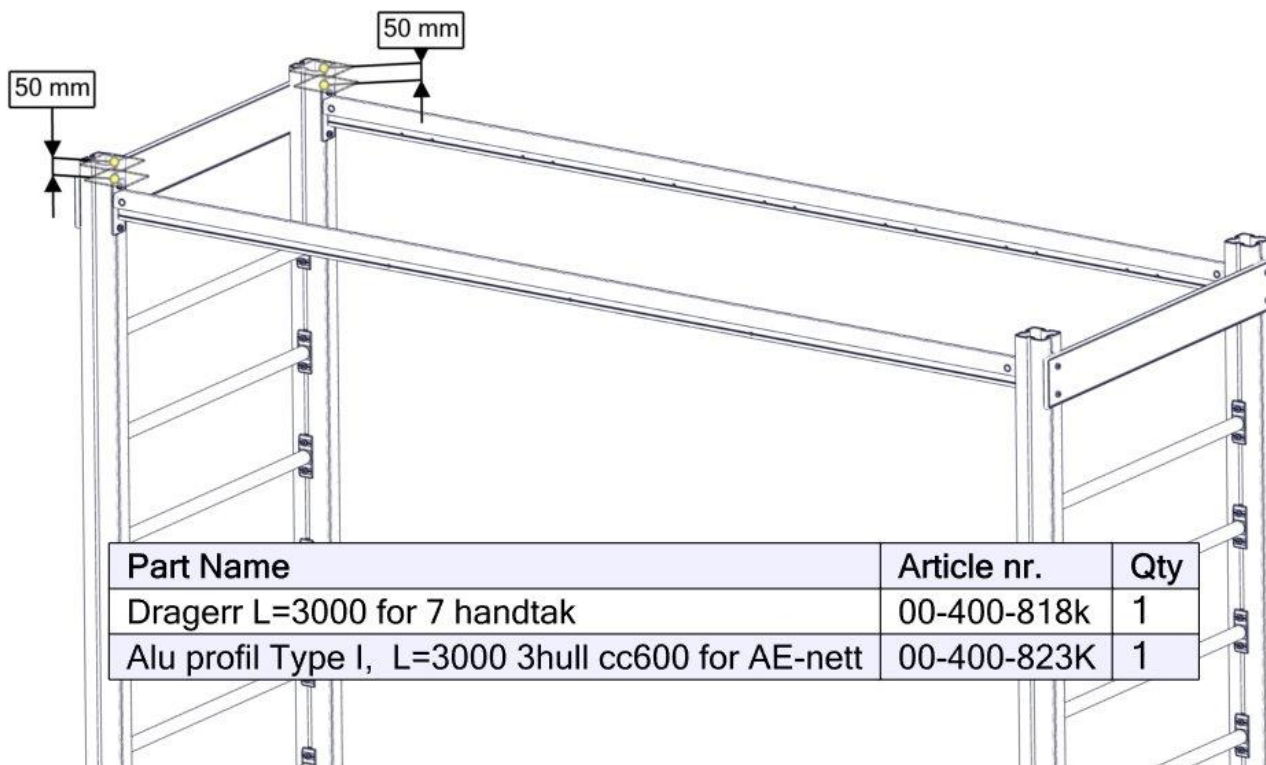

Part Name	Article nr.	Qty
Dragerr L=3000 for 7 handtak	00-400-818k	1
Alu profil Type I, L=3000 3hull cc600 for AE-nett	00-400-823K	1

Montering av lekeapparatet / Assembly instructions / Montering av lekredskapet

Se separat delmontering for detaljer
 See separate assembly for details
 Se separata delmontering för detaljer

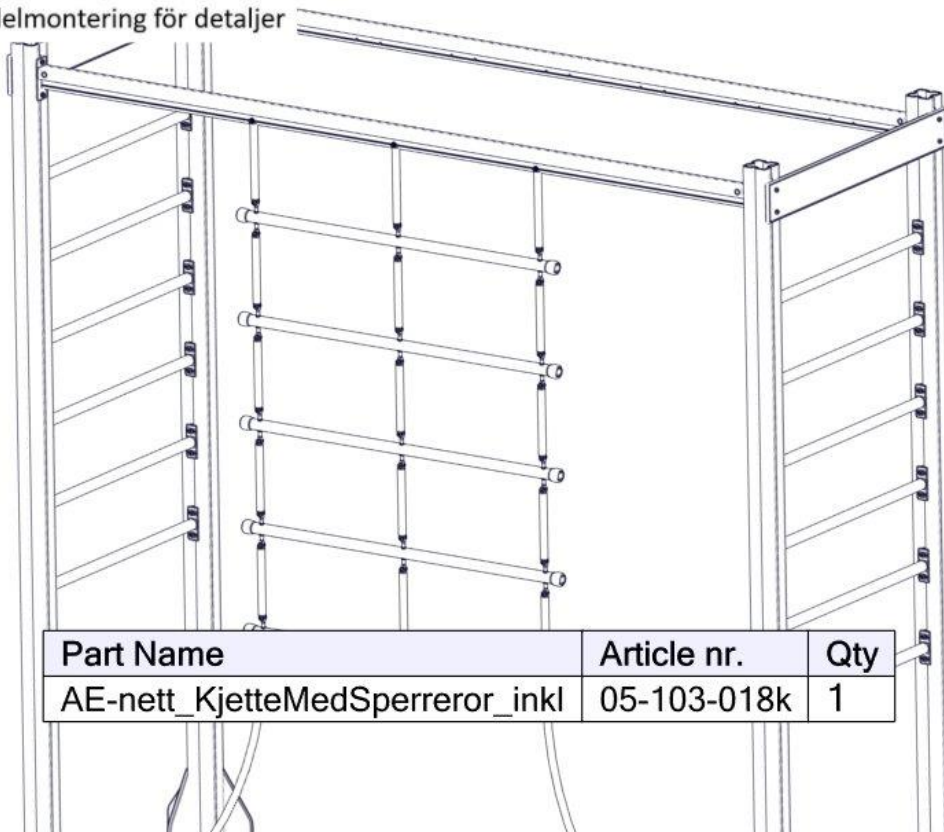

Part Name	Article nr.	Qty
AE-nett_KjetteMedSperreror_inkl	05-103-018k	1

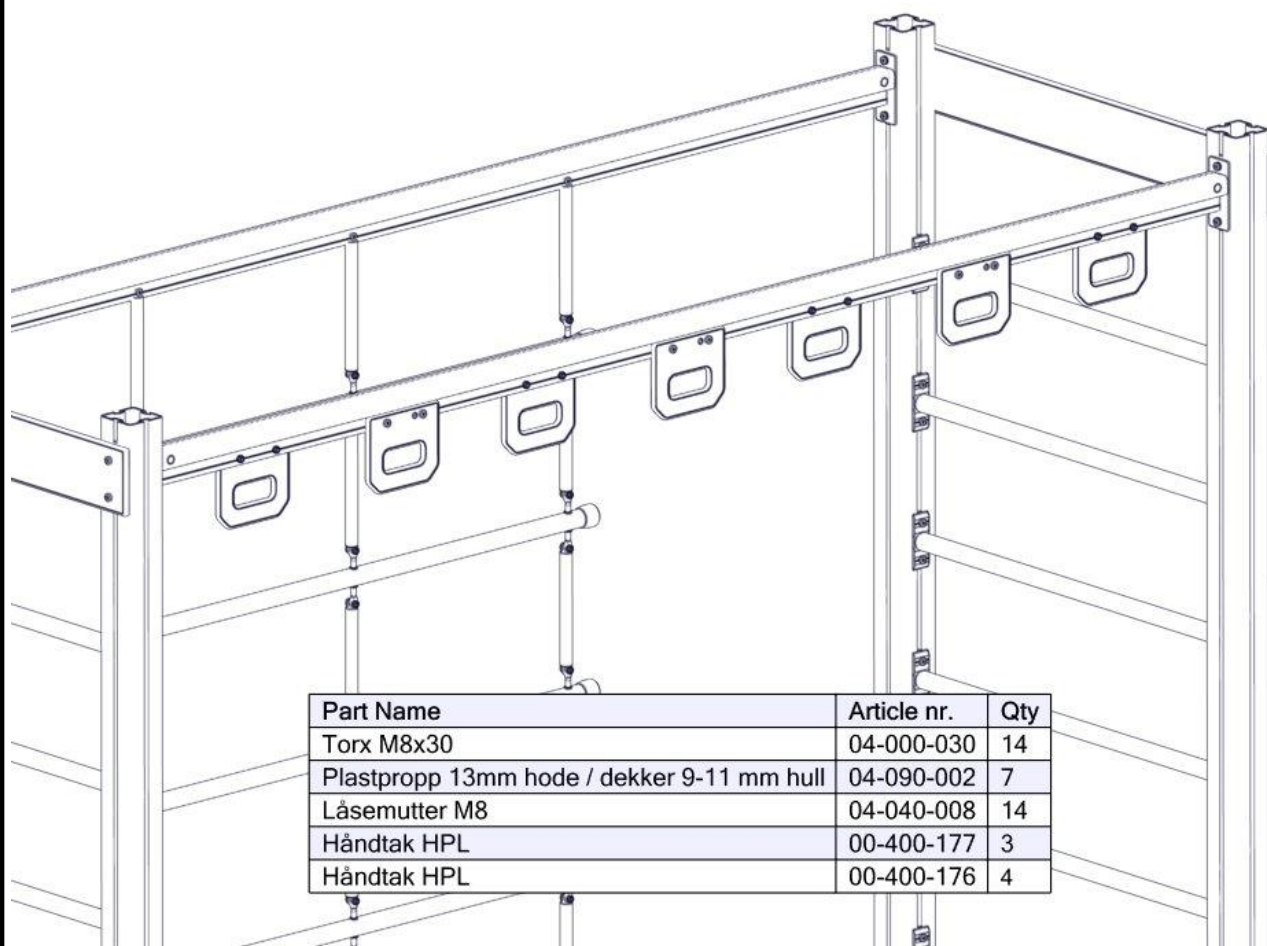



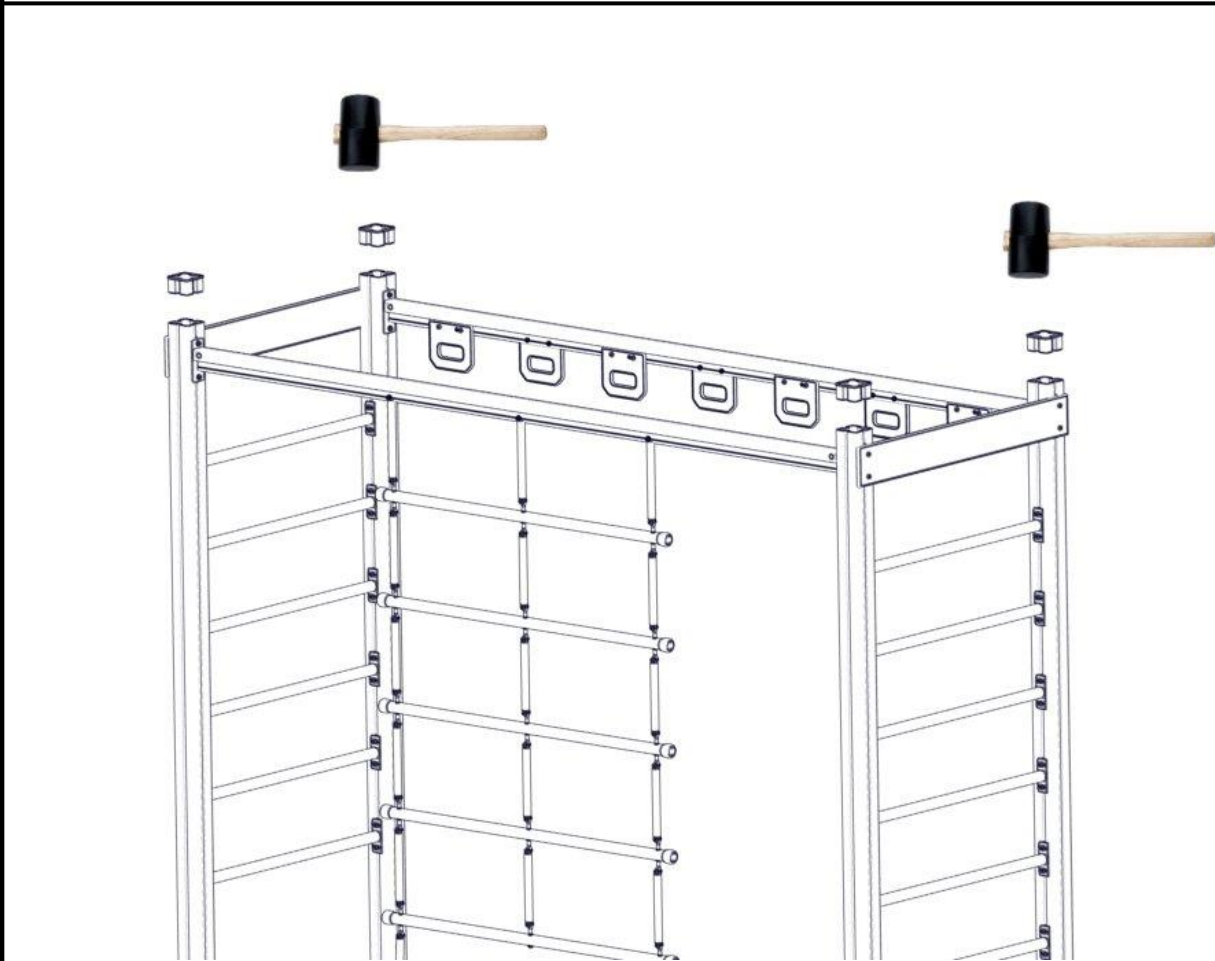
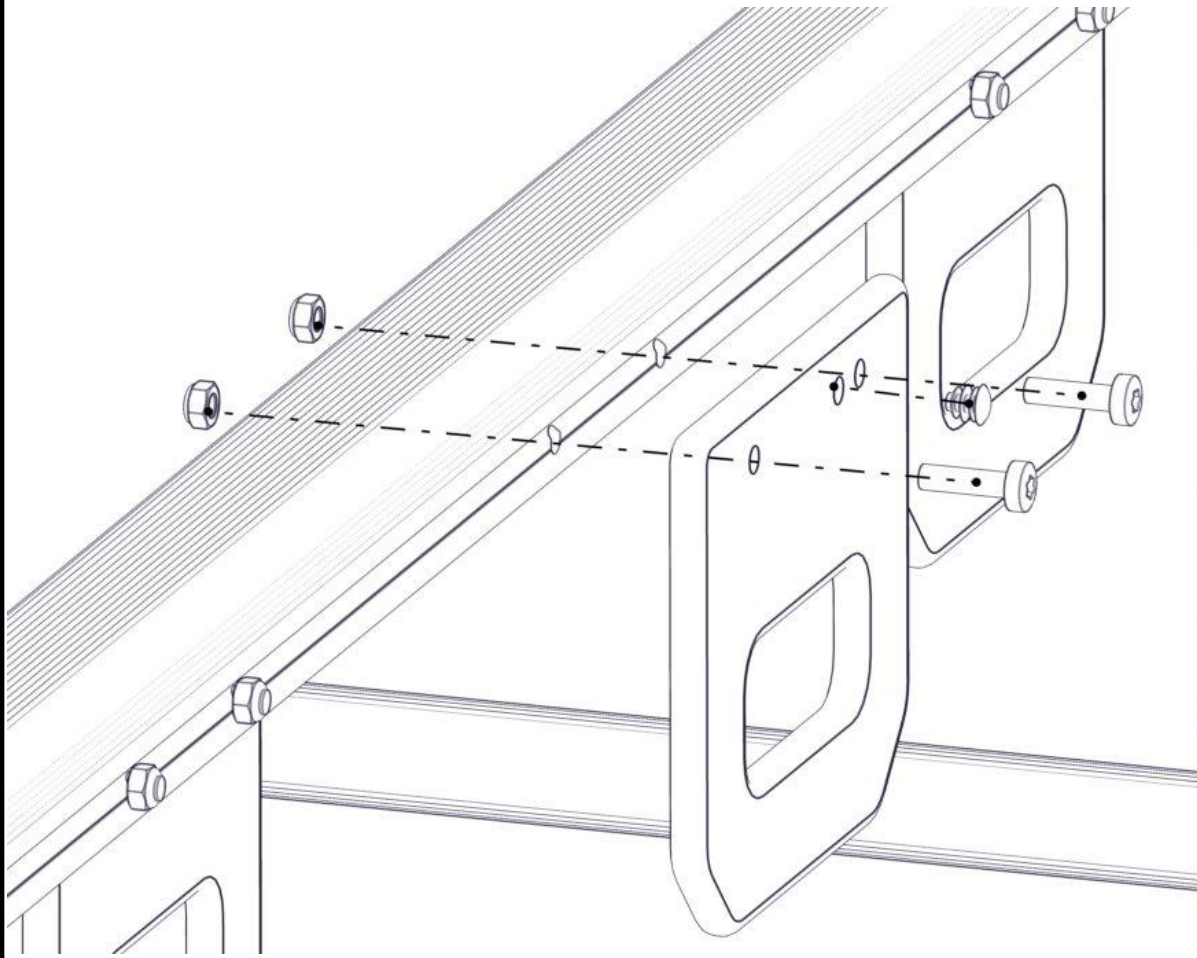



Part Name	Article nr.	Qty
Torx M8x30	04-000-030	14
Plastpropp 13mm hode / dekker 9-11 mm hull	04-090-002	7
Låsemutter M8	04-040-008	14
Håndtak HPL	00-400-177	3
Håndtak HPL	00-400-176	4

Montering av lekeapparatet / Assembly instructions / Montering av lekredskapet

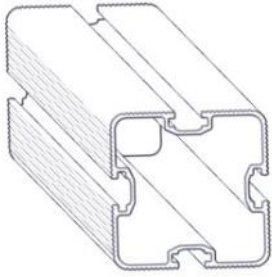
Før utstyret tas i bruk / Before play begins / Innan lekredskapet tas i bruk	
N	<ul style="list-style-type: none"> ● Påse at fallunderlag er utlagt i henhold til gjeldende regler eller vår anbefaling ● Fjern alle monteringshjelpemidler (rester av betong, planker, paller, plast, og lignende) ● Før utstyret tas i bruk, burde man sjekke at det ikke er fare for at anorakksnorer og lignende som kan hekte seg fast noen steder på lekeapparatet. (Vedlagte snor med dobbe (kneledd) kan brukes til å sjekke at dette er i orden. Se vedlagte veiledning for bruk av denne. Dette gjøres for å oppdage eventuelle feilmonteringer.?) ● NB! Bør stå i 2-3 dager før bruk
EN	<ul style="list-style-type: none"> ● Make sure the area and depth of safer surfacing are according to the current standard, or to the manufacturer's recommendation ● Make sure all tools and surplus materials are removed before play begins ● PS! When complete, allow 2-3 days for the concrete to set before use
S	<ul style="list-style-type: none"> ● Kontrollera att fallunderlag är utlagt enligt gällande regler eller vårt rekommendation ● Ta bort alla monteringshjälpmedel (rester av betong, plankor, pallar, plast och liknande) ● Innan lekredskapet används, kontrollera att anoracksnoddar eller kläder/delar av kläder eller liknande inte kan fastna i några delar på redskapet. (Den bipackade "knävringen" kan man med fördel användas för denna kontroll. ● Detta görs för att upptäcka eventuella felmonteringar.)







Boltepakker for / Boltpackage for / Bultpaket för

Sign. _____.

Ekornet Sort/Gul 31-400-060	Navn	Artnr/ dimensjon	Ant	Lev
	Stolpe 95x95 L= 3230 (800-2430) Sort	SFA5117/1	4	
	Sperrerør STD L=940 Gul	00-400-150K (se egen del- montering)	12	
	Endelokk 95x95 Sort	00-400-998	4	
	Sprosse HPL standard Sort	00-400-103K (se egen del- montering)	2	
	Drager L=3000 for 7 handtak Sort	00-400-818K (se egen del- montering)	1	
	Alu profil Rype I, L=3000 3 hull cc 600 Sort	00-400-823K (se egen del- montering)	1	



Boltepakker for / Boltpackage for / Bultpaket för

Sign. _____.

Ekornet Sort/Gul 31-400-060	Navn	Artnr/ dimensjon	Ant	Lev
	Produktmerke	00-100-401 (Montert hos Søve)	0	
	AE- nett kjetting med sperreør Rød/Gul	05-103-022K (se egen del- montering)	1	
	Håndtak HPL Rød Håndtak HPL, Gul	00-400-177 00-400-176	3 4	
	Torx M8x30	04-000-030	14	
	Låsemutter M8	04-040-008	14	
	Plastpropp 13mm hode 9-11	04-090-002	7	

Boltepakker for / Boltpackage for / Bultpaket för

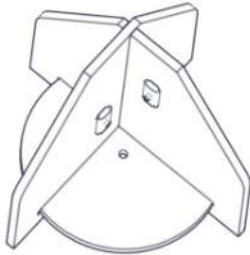
Sign. _____.

Ekornet Sort/Gul 31-400-060	Navn	Artnr/ dimensjon	Ant	Lev
	<u>For nedgraving</u>			
	Nedgravingsfundament 95x95	00-003-004K (se egen del- montering)	4	
	<u>For støping</u>			
	Støpe fundament	00-003-110K	4	