

N

Monteringsanvisning

EN

Assembly Instructions

S

Monteringsanvisning

Produkt nr. / Product no. / Produkt nr.

31-400-080

Ordr. nr. _____

Dato. _____

Sign. _____

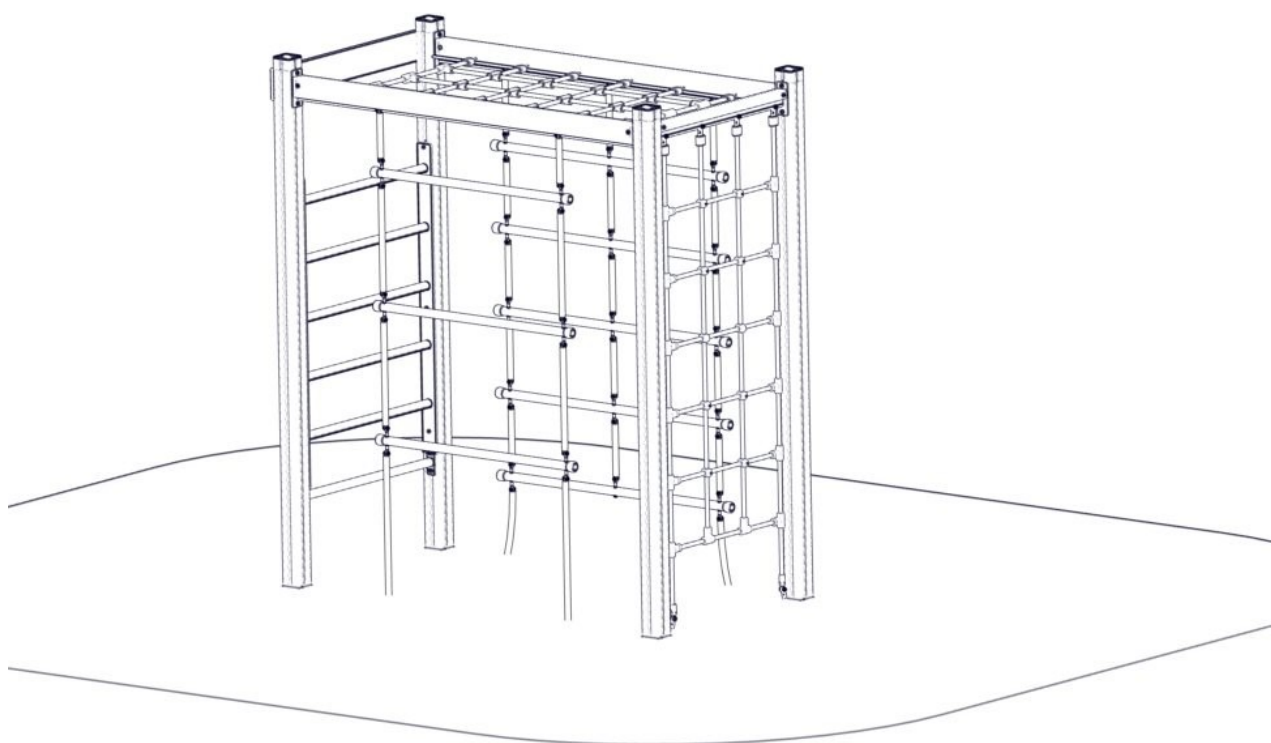
**søve**

Søve AS
Grønnvoldveien 290
3830 Ulefoss - Norway
Tlf: +47 35 94 65 65
www.sove.no

**søve**

Søve AB
EA Rosengrensgatan 32
421 31 Västra Frölunda
Phone: +46 (0)31 773 97 00
www.sove.se

Monteringstips / Assembly Advice / Monteringsstips

N

- Les monteringsanvisningen nøye før montering.
- Monter elementene i rekkefølgen som vist.
- Boltene bør ikke skrues for hardt til før alt er montert, vatret og loddet. Skru så boltene til.
- NB! Ved bruk av drill, kan boltene ryke.
- På grunn av at solen kan gjøre rutsjeplaten veldig varm, bør rutsjebanens utløp vende mot nord-øst eller nord-vest.
- Er lekeutstyret plassert i naturlige ferdselstraséer må området sikres mot gjennomgang.
- Innspringningshinder bør vurderes rundt lekeapparater hvor det er stor bevegelse, f.eks. ved huskestativ.
- Det bør være fritt innsyn til lekeutstyr som er beregnet for barn under 3 år.

NB! Under monteringsarbeidet må utstyr, som ikke er forankret forsvarlig i bakken, sikres slik at det ikke velte.

Området må avstenges under montering av apparatene med sperrebånd eller lignende.

EN

- Read the instruction carefully before assembling the play unit.
- Assemble the components in the sequence shown in these instructions. Fixings must not be fully tightened during assembly. Before casting the foundations, the structure must be level and plumb, at which point all fixings are tightened. PSI If use of drill, the bolts may be wrecked.
- Avoid positioning the slide facing due south because of overheating – ideal positions are facing north-east or north-west. Secure the construction-area to prevent people from walking through it.
- Consider installing barriers around play-equipment which gives rise to a lot of activity – i.e.swings.
- Ensure that clear vision is possible across the play area so that supervision is possible from any position, particularly where children under 3 years of age will be playing.

NB! During assembly of the equipment, ensure that all structures are securely propped, especially when left overnight. Also ensure that equipment is supported

Monteringstips / Assembly Advice / Monteringsstips**S**

- Läs monteringsanvisningen noga före montering.

- Montera delarna i den ordningen som anvisas
- Skruvarna bör inte skruvas för hårt tills allt är monterat, i våg och lodat.









OBS! Används elektrisk skruvdragare, kan bulten gå sönder. Hårdra därför manuellt!

- Solen kan göra att rutchbanan blir väldigt varm. Banans nedfart rekommenderas att vändas i norrlig riktning
- Om lekplatsen placeras vid en gångväg mm bör området säkras mot genomfart av gående och cyklister.
- Insprängningshinder bör placeras runt lekutrustning med stor rörelse, t ex, gungställning.
- Det bör vara fri insyn till lekutrustning beräknat till barn under 3 år.

OBS! Under monteringsarbete bör utrustningen som inte ska förankras i marken, ställs så att den inte kan välta.

Området måste spärras när lekutrustningen byggs upp, med avspärrningsband eller liknande.

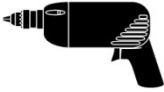
Nødvendig verktøy / Tools required / Nödvändiga verktyg

<p>(N)</p> <p>(EN)</p> <p>(S)</p>	<p>(A)</p> 	<p>(B)</p>  <p>Torx Nr 45 High quality</p>	<p>(C)</p> <p>5 mm 6 mm</p> 	<p>(D)</p> 	<p>(E)</p> 
		<p>Metermål Metric measure Tumstock</p> 	<p>16 V</p> 	<p>Merkebånd Mark ribbon Märkeband</p> 	<p>13 + 17mm</p> 

Nødvendig antall personer / Number of persons required / Rekommenderad antal personer





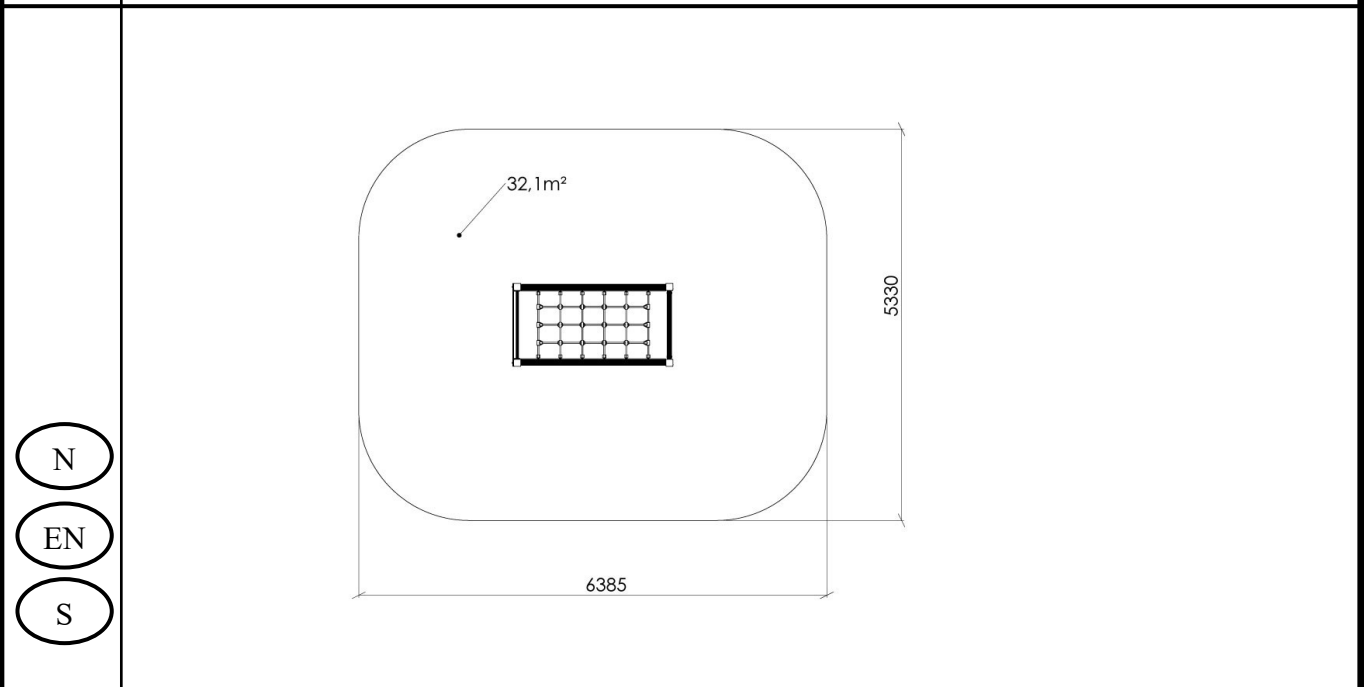





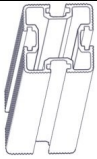

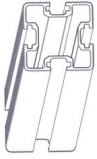

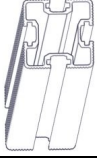
Anbefalt arealbehov ved montering / Recommended working space / Rekommenderad arealbehov vid montering



Boltepakker for / Boltpackage for / Bultpaket för

Sign. _____

Stolpe 95x95	Ant= 4	Navn	Artnr/dimensjon	Ant	Lev
		VK95 3230 800-2430 (1)	00-400-038	2	
		Stolp ende (1)	00-400-998	2	
Stolpe 95x95 med HPL	Ant= 1	Navn	Artnr/dimensjon	Ant	Lev
 Høyre		VK95 3230 800-2430 (1)	00-400-016	1	
		Stolp ende (1)	00-400-998	1	
Stolpe 95x95 med HPL	Ant= 1	Navn	Artnr/dimensjon	Ant	Lev
 Venstre		VK95 3030 600-2430 (1)	00-400-017	1	
		Stolp ende (1)	00-400-998	1	
Ribbevegge	Ant= 1	Navn	Artnr/dimensjon	Ant	Lev
		Sperrerør L=940	00-400-149(5)	5	
		Sperrerør med beslag	00-400-150(1)	1	
		Sprosse 1130x145x12 Svart	00-400-097(1)	1	
		Brikke_120_3T Brikke_150_3T Montert hos Søve	04-060-120(2) 04-060-150(2)	2 0	
		Torx M8x25 Torx M8x35	04-000-025 04-000-035	4 4	







Boltepakker for / Boltpackage for / Bultpaket för

Sign. _____

Drager	Ant= 1	Navn	Artnr/dimensjon	Ant	Lev
		Drager: L=1980 6 hull Horizontal 2 hull vertikal	00-400-859	1	
Drager	Ant= 2	Navn	Artnr/dimensjon	Ant	Lev
		Drager: L=1980 6 hull Horizontal 3 hull vertikal	00-400-857	1	
Drager	Ant= 1	Navn	Artnr/dimensjon	Ant	Lev
		Drager: L=940 4 hull vertikal	00-400-815	1	
Festemidler drager	Ant=	Navn	Artnr/dimensjon	Ant	Lev
		Brikke 180_3T Montert hos Søve	04-060-180	0	
		Brikke 160_2T	04-060-160	2	
		Torx M8x25	04-000-025	12	
	Skive M8	04-050-008	12		
Produktmerke	Ant= 1	Navn	Artnr/dimensjon	Ant	Lev
		Produktmerking Hos Søve	25-200-180	0	

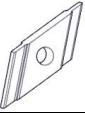

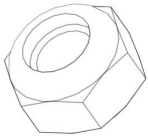
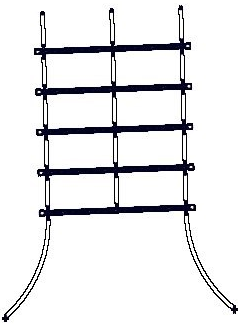

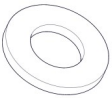
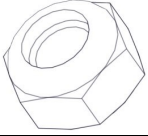

Boltepakker for / Boltpackage for / Bultpaket för

Sign. _____.

M-nett	Ant= 1	Navn	Artnr/dimensjon	Ant	Lev
		M-Nett	05-079-014	1	
		Torx M8x25	04-000-025	6	
		Brikke skrå 15-1T	04-060-053	2	
		Skive M8	04-050-008	4	
		Låsemutter M8	04-040-008	4	
Æ-nett	Ant= 1	Navn	Artnr/dimensjon	Ant	Lev
		Æ-Nett	05-103-018	1	
		Torx M8x25 Torx M8x35	04-000-025 04-000-035	3 2	
		Brikke skrå 15-1T	04-060-053	2	
		Skive M8	04-050-008	5	
		Låsemutter M8	04-040-008	3	

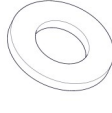
Boltepakker for / Boltpackage for / Bultpaket för

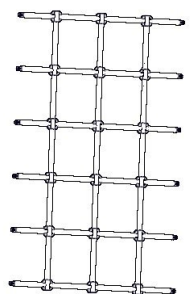
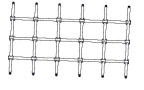
Sign. _____

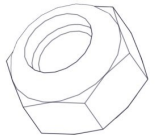
ÅÅ-nett	Ant= 1	Navn	Artnr/dimensjon	Ant	Lev
		ÅÅ-nett	05-103-016	1	
		Torx M8x25 (2) Torx M8x35(2)	04-000-025 04-000-035	2 2	
		Skive M8 (2) Skive M8 stor	04-050-008 04-055-008	2 2	
		Låsemutter M8 (4)	04-040-008	4	
		Fundamentplate (2)	00-003-103	2	
Tak--nett	Ant= 1	Navn	Artnr/dimensjon	Ant	Lev
		Tak-Nett	05-100-006	1	
		Torx M8x25	04-000-025	12	
		Skive M8	04-050-008	12	
		Låsemutter M8	04-040-008	12	

Boltepakker for / Boltpackage for / Bultpaket för

Sign. _____.

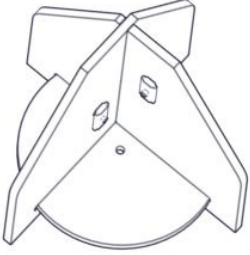
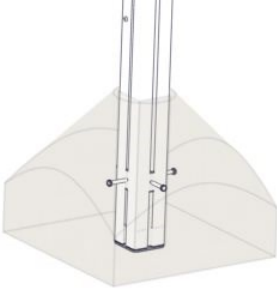
	Navn	Artnr/ dimensjon	Ant	Lev
	Fundament Nedgraving			
	Nedgravingsfundament Til 95x95 stolpe	00-003-004K	4	
	Fundament Støp			
	Fundament til støp Til 95x95 stolpe	00-003-110K	4	

Fundamentering med betong // Foundation concrete // Förankring med betong

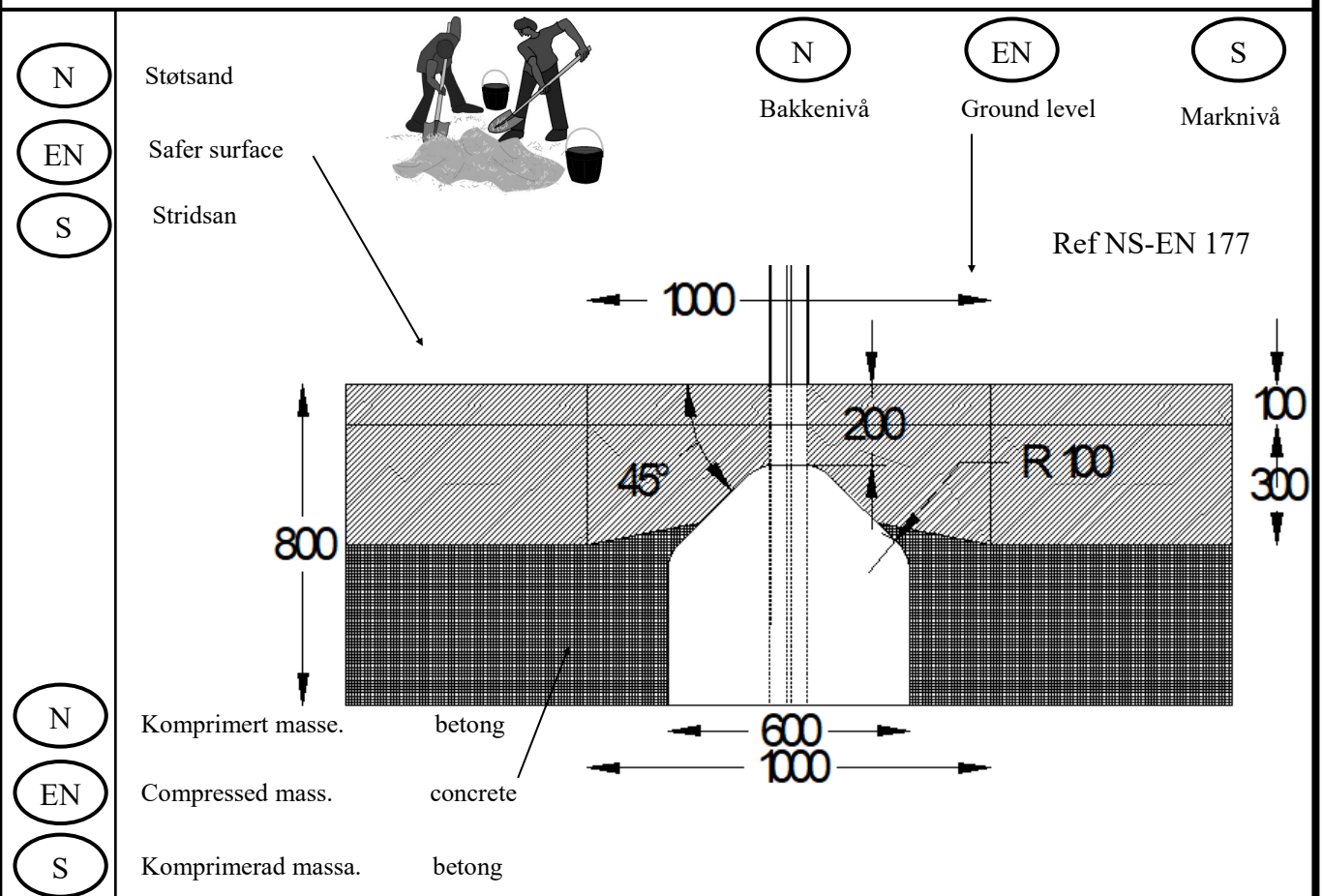

Fundamentering uten betong // Foundation without concrete // Förankring utan betong

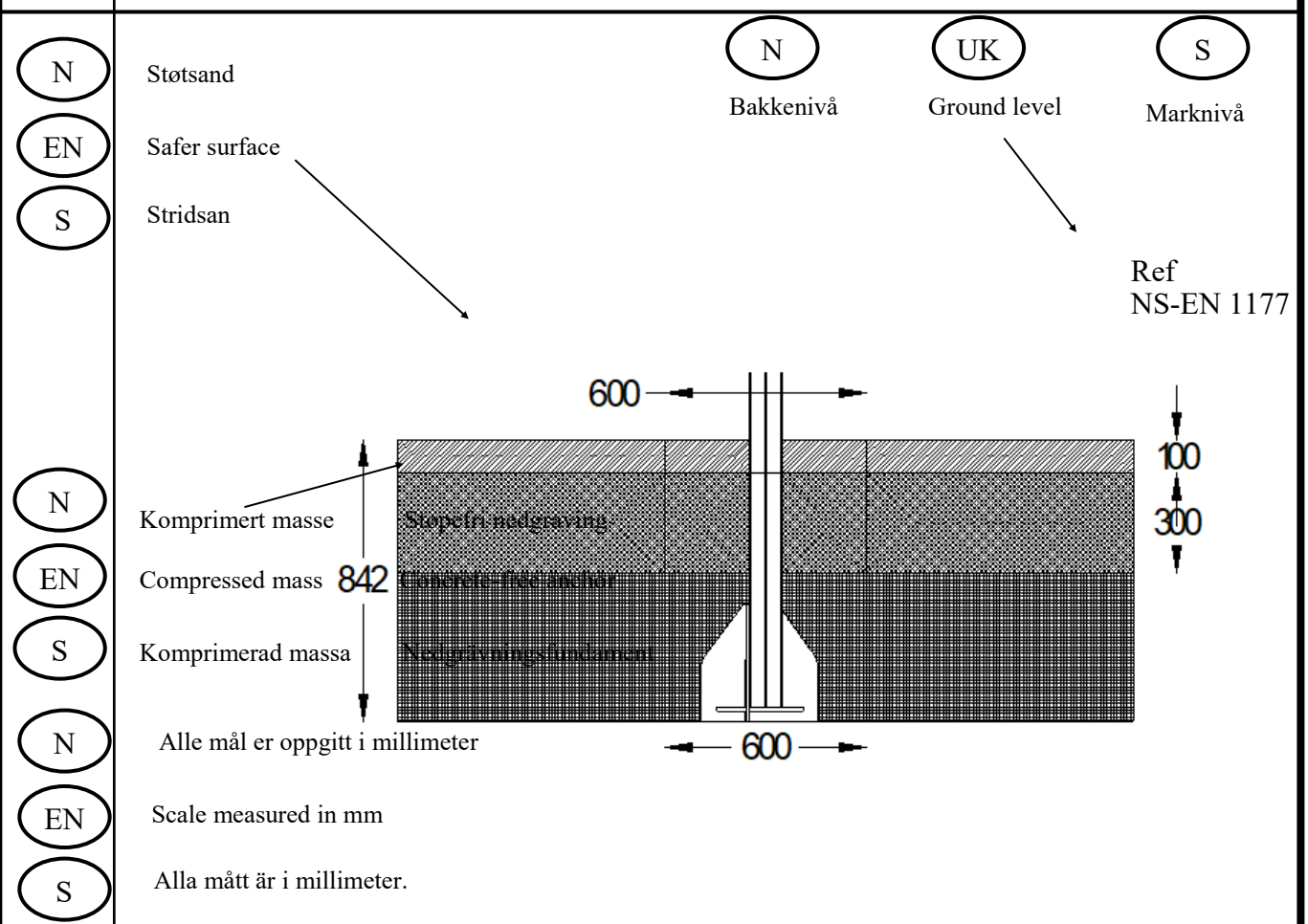

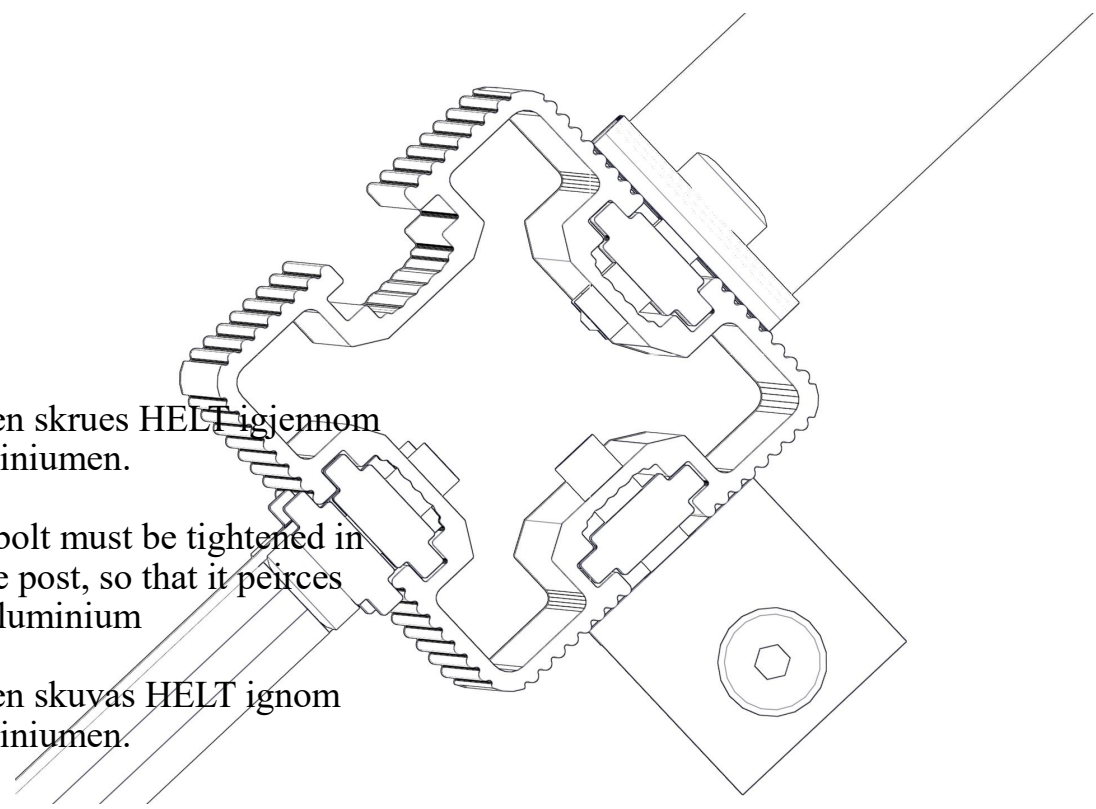
<p data-bbox="124 1556 220 1624">N</p> <p data-bbox="124 1691 220 1758">EN</p> <p data-bbox="124 1848 220 1915">S</p>	 <p data-bbox="239 1579 702 1668">Bolten skrues HELT igjennom aluminiumen.</p> <p data-bbox="239 1691 686 1825">The bolt must be tightened in to the post, so that it peirces the aluminium</p> <p data-bbox="239 1848 662 1937">Bulten skruvas HELT ignom aluminiumen.</p>

Fallhøyder / Free height of fall / Fallhöjder

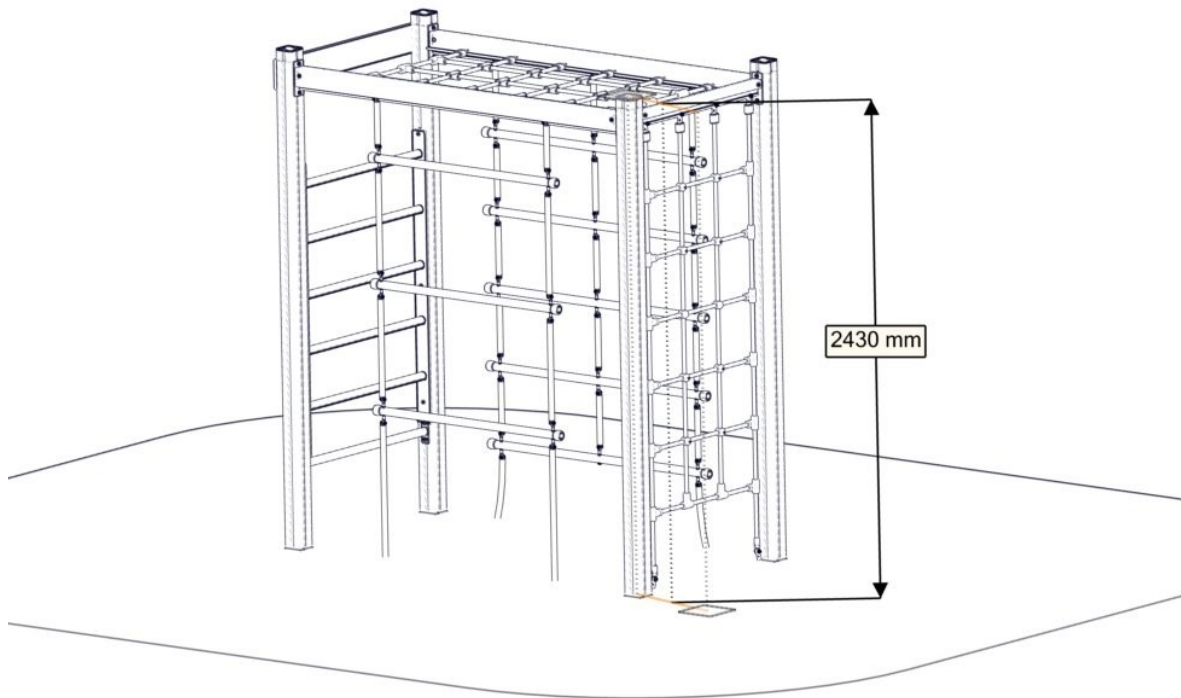

Sikkerhetszone / Safety zone / Säkerhetszon

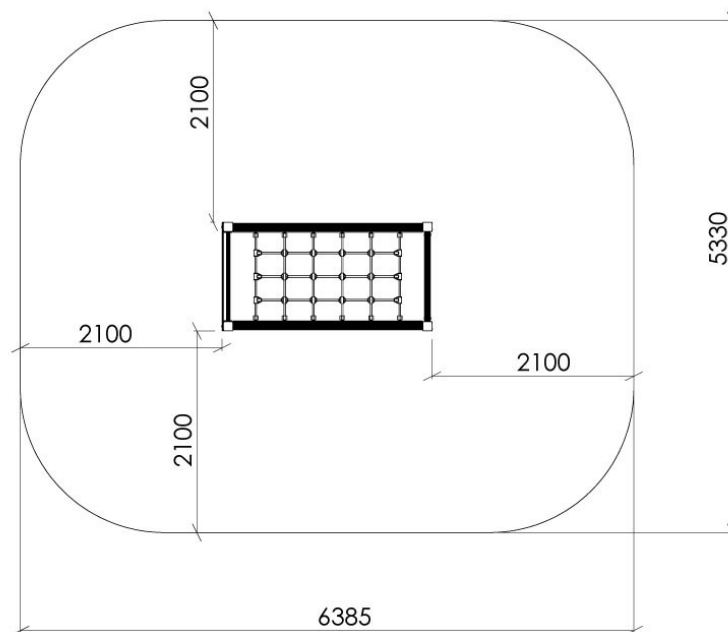

Plassering av forankringer / Ground plan / Placering av förankringar

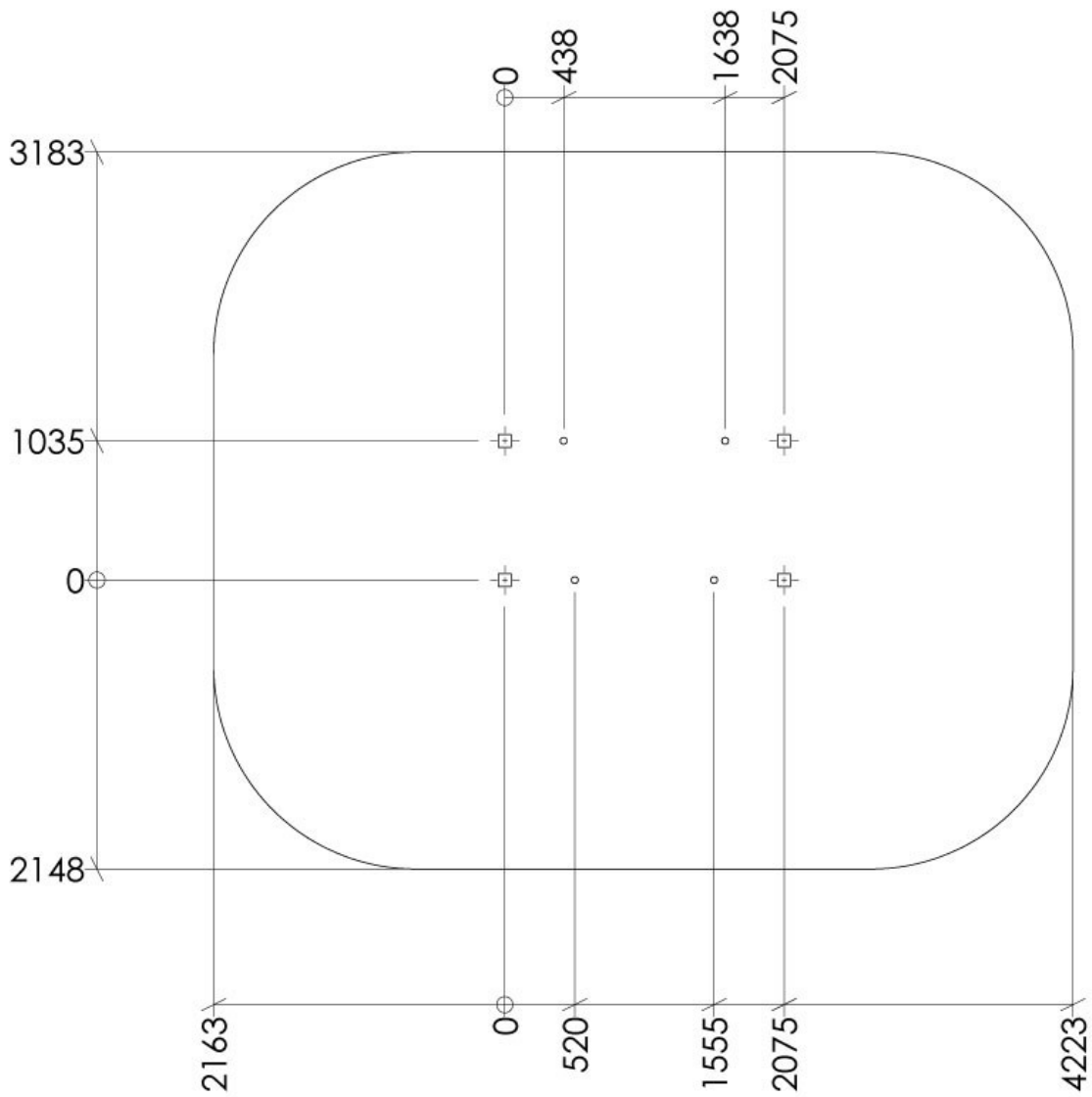

N

Alle mål er oppgitt i millimeter

EN

Scale measured in mm

S

Alla mått är i millimeter.

Montering av lekeapparatet / Assembly instructions / Montering av lekredskapet

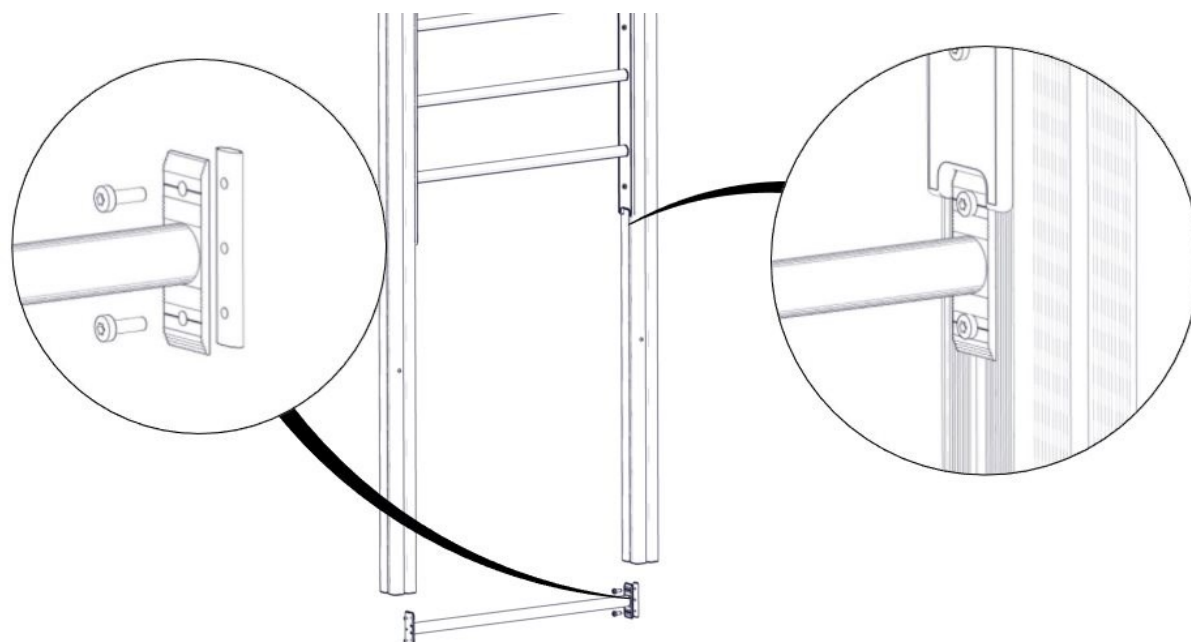
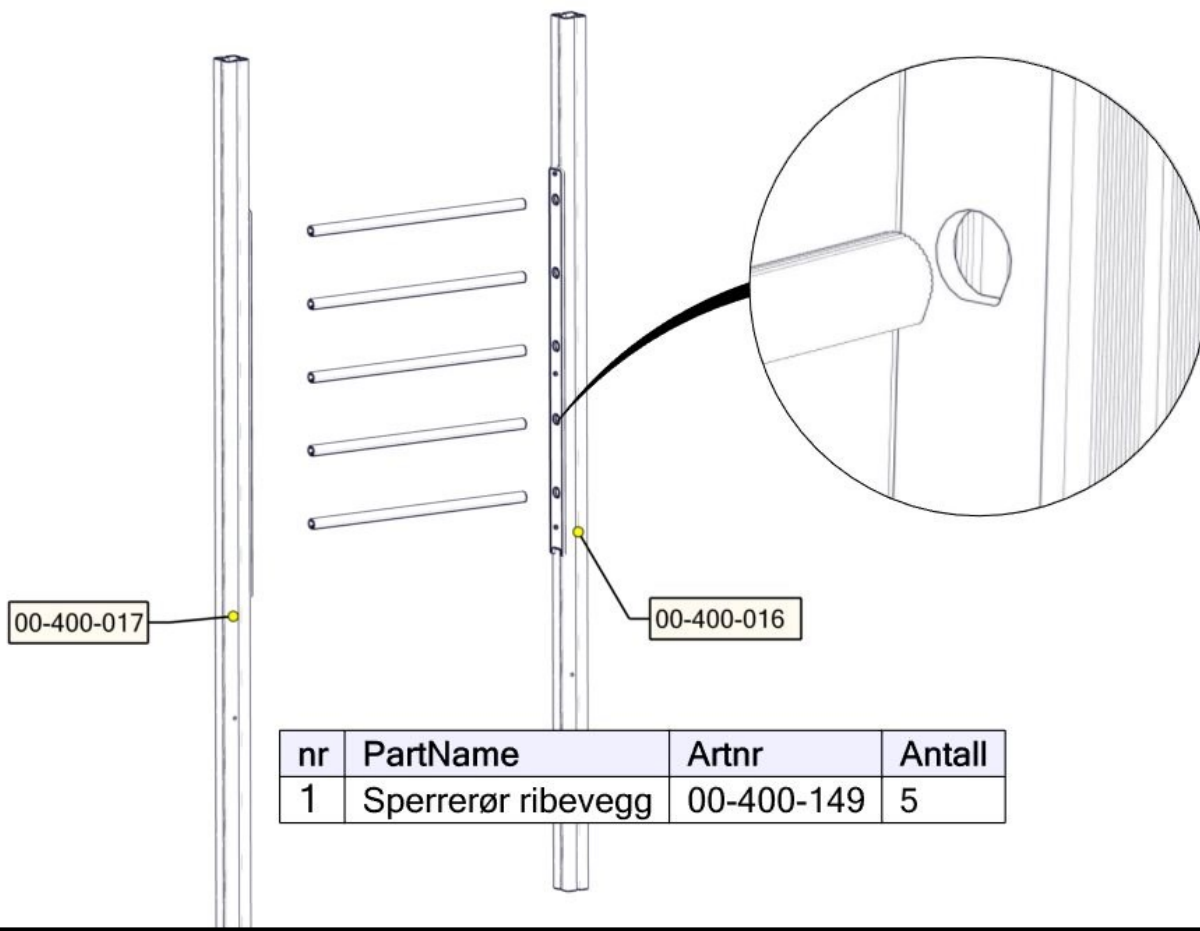

nr	PartName	Artnr	Antall
1	Sperrerør Std L=940	00-400-150	1
2	Torx M8x25	04-000-025	4
3	Brikke 120 3xM8	04-060-120	2

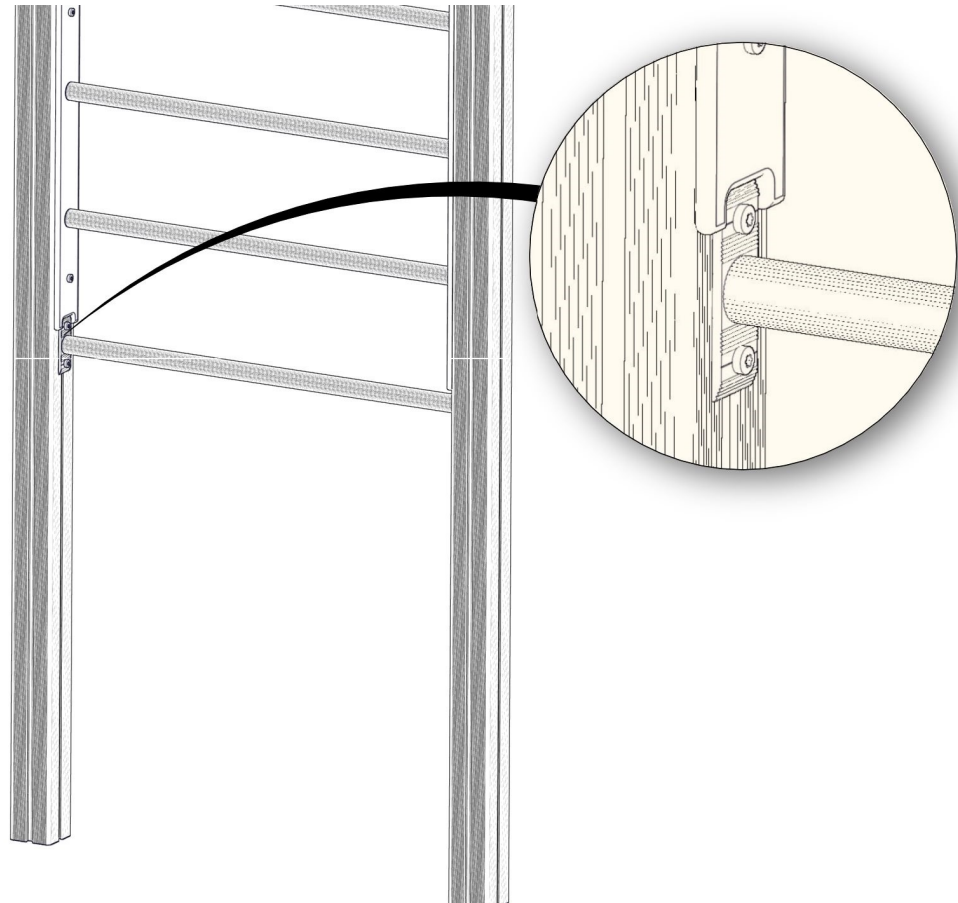
Montering av lekeapparatet / Assembly instructions / Montering av lekredskapet

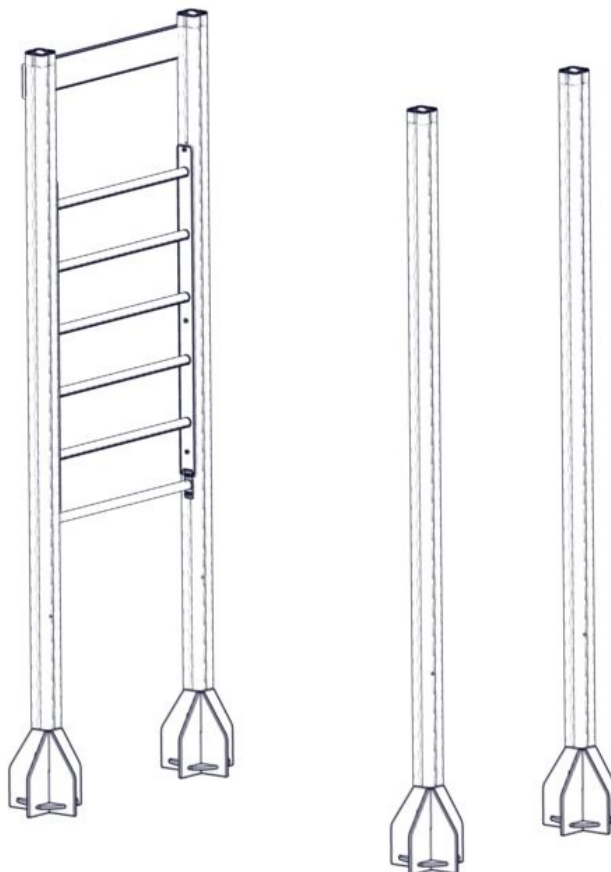
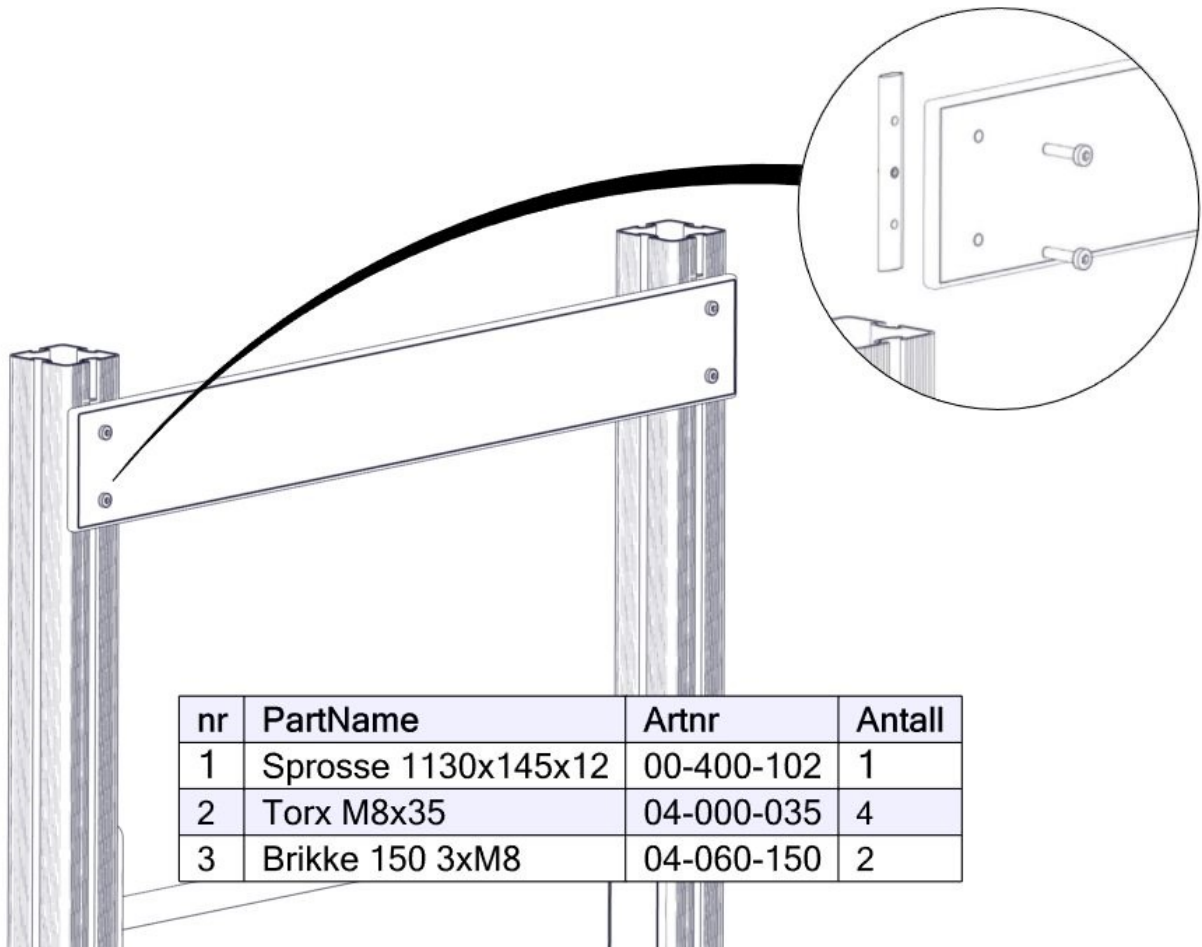

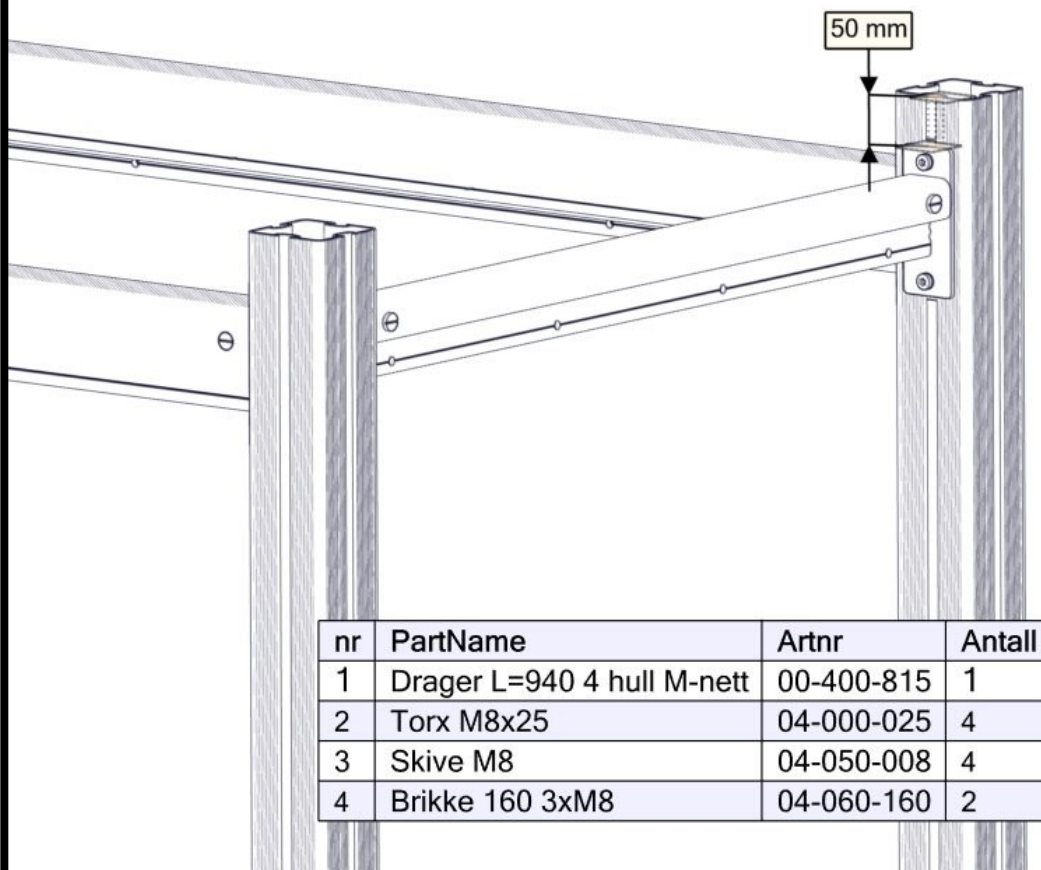
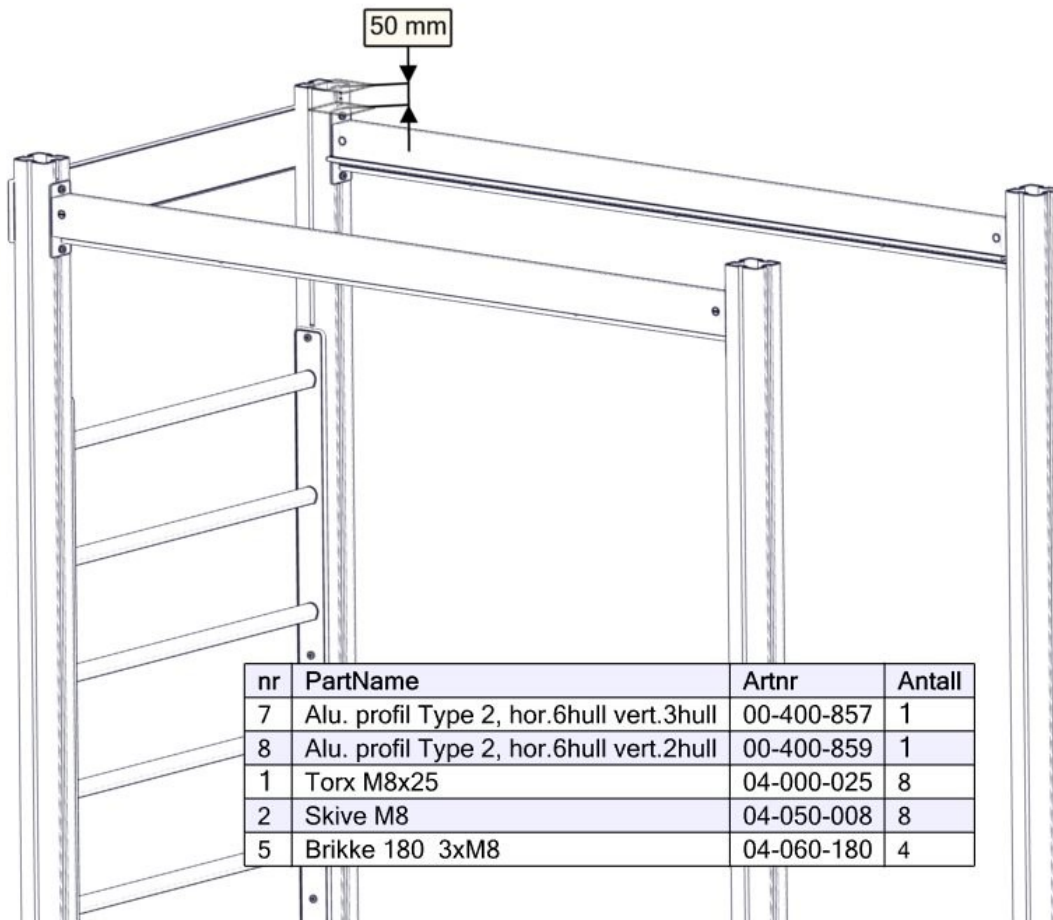

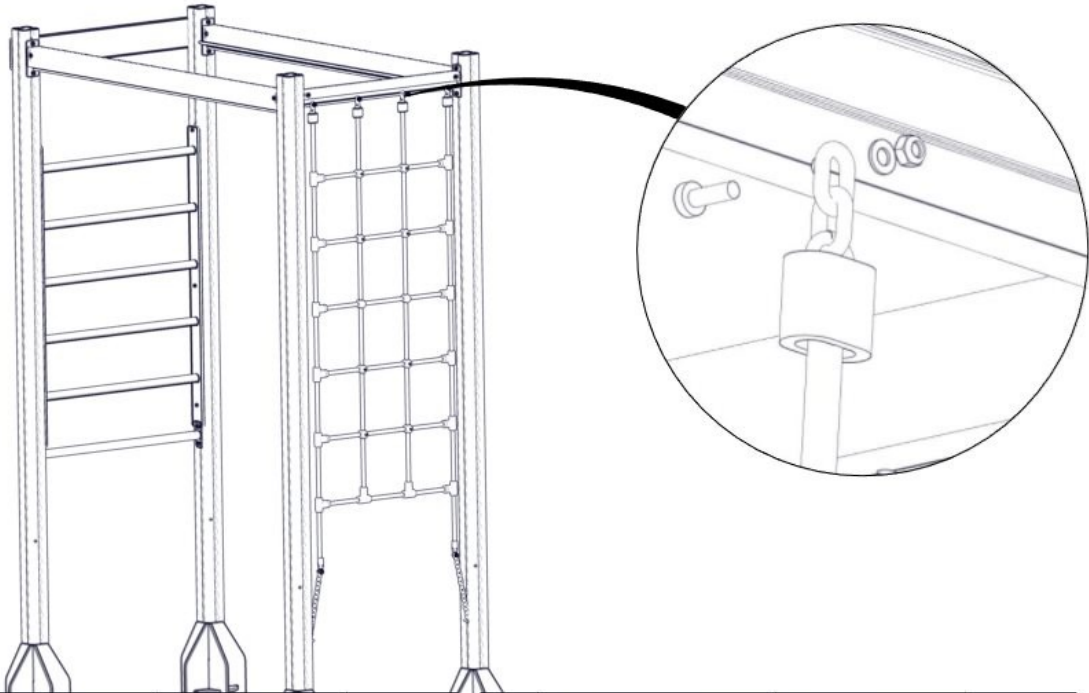

nr	PartName	Artnr	Antall	nr	PartName	Artnr	Antall
2	Torx M8x25	04-000-025	4	1	M-nett	05-079-014	1
3	Låsemutter M8	04-040-008	4				
4	Skive M8	04-050-008	4				

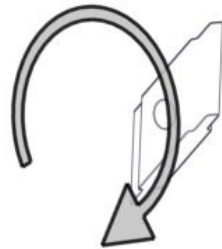

nr	PartName	Artnr	Antall
2	Brikke skraa 15 1xM8	04-060-053	1

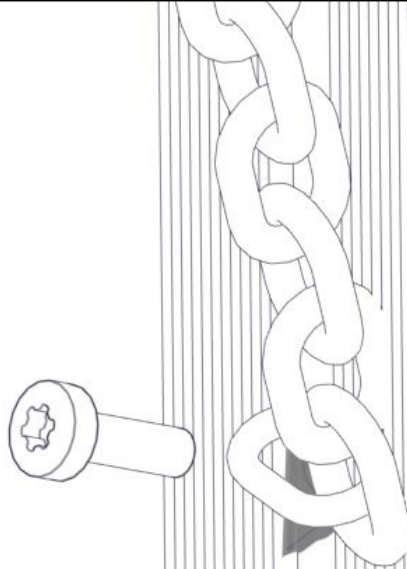

nr	PartName	Artnr	Antall
1	Torx M8x25	04-000-025	1

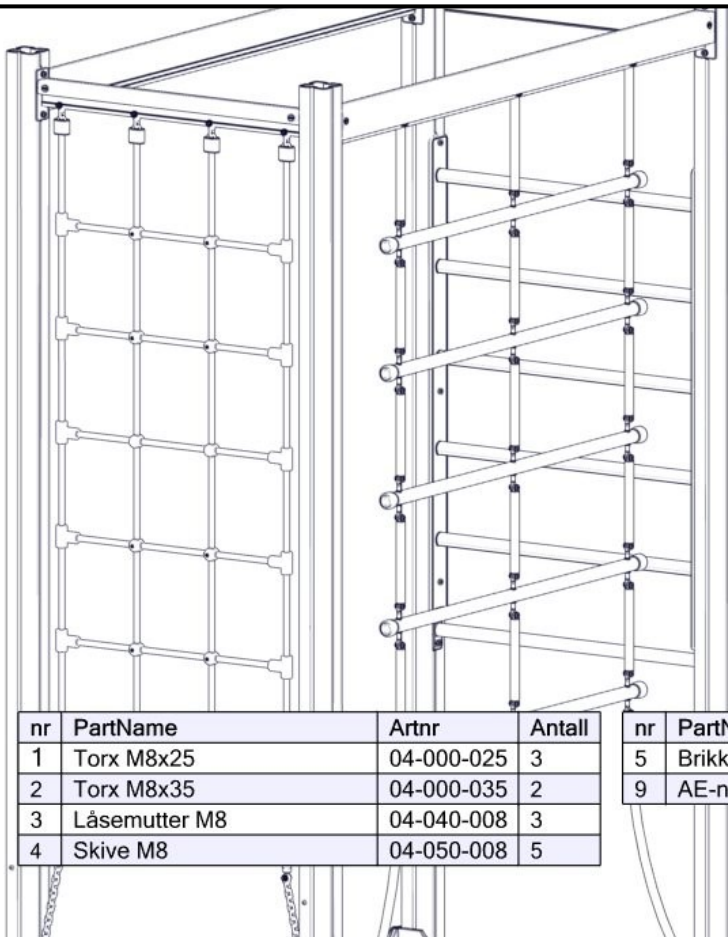

nr	PartName	Artnr	Antall
1	Torx M8x25	04-000-025	3
2	Torx M8x35	04-000-035	2
3	Låsemutter M8	04-040-008	3
4	Skive M8	04-050-008	5

nr	PartName	Artnr	Antall
5	Brikke 50 1XM8	04-060-050	2
9	AE-nett_KjetteMedSperreror	05-103-018	1

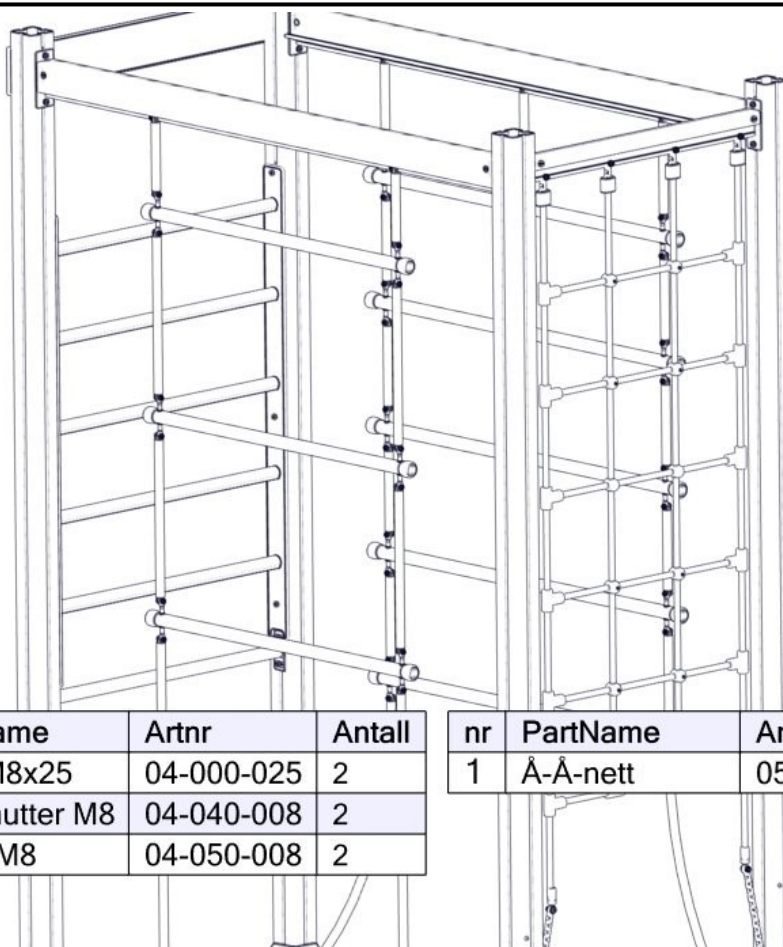

nr	PartName	Artnr	Antall
2	Torx M8x25	04-000-025	2
3	Låsemutter M8	04-040-008	2
4	Skive M8	04-050-008	2

nr	PartName	Artnr	Antall
1	Å-Å-nett	05-103-016	1

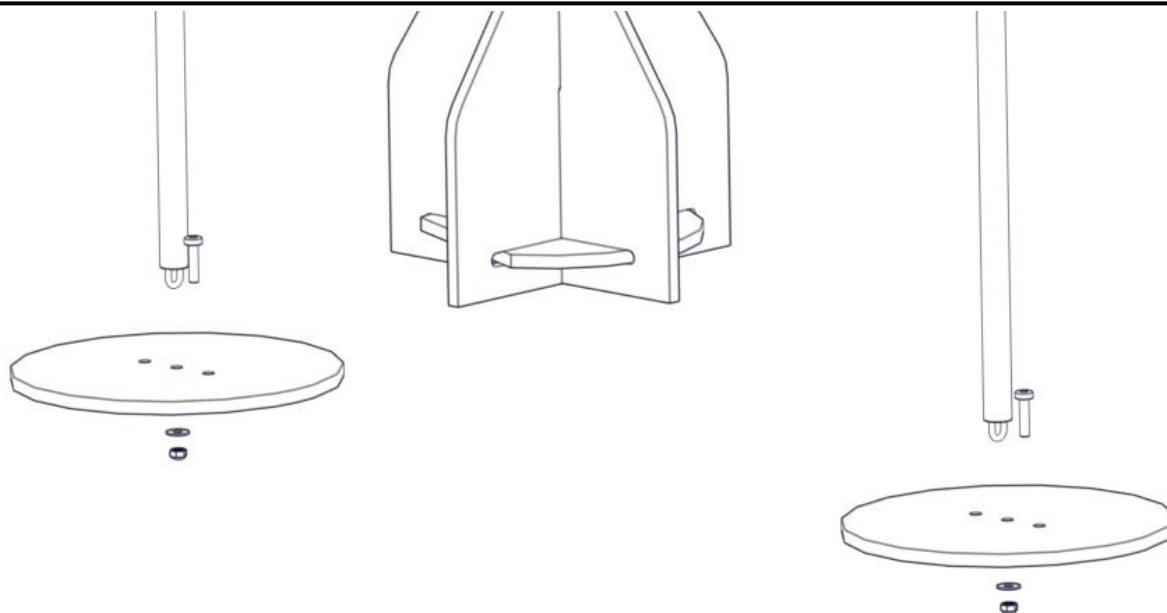

nr	PartName	Artnr	Antall
1	Fundament plate	00-003-103	2
2	Torx M8x35	04-000-035	2
3	Låsemutter M8	04-040-008	2



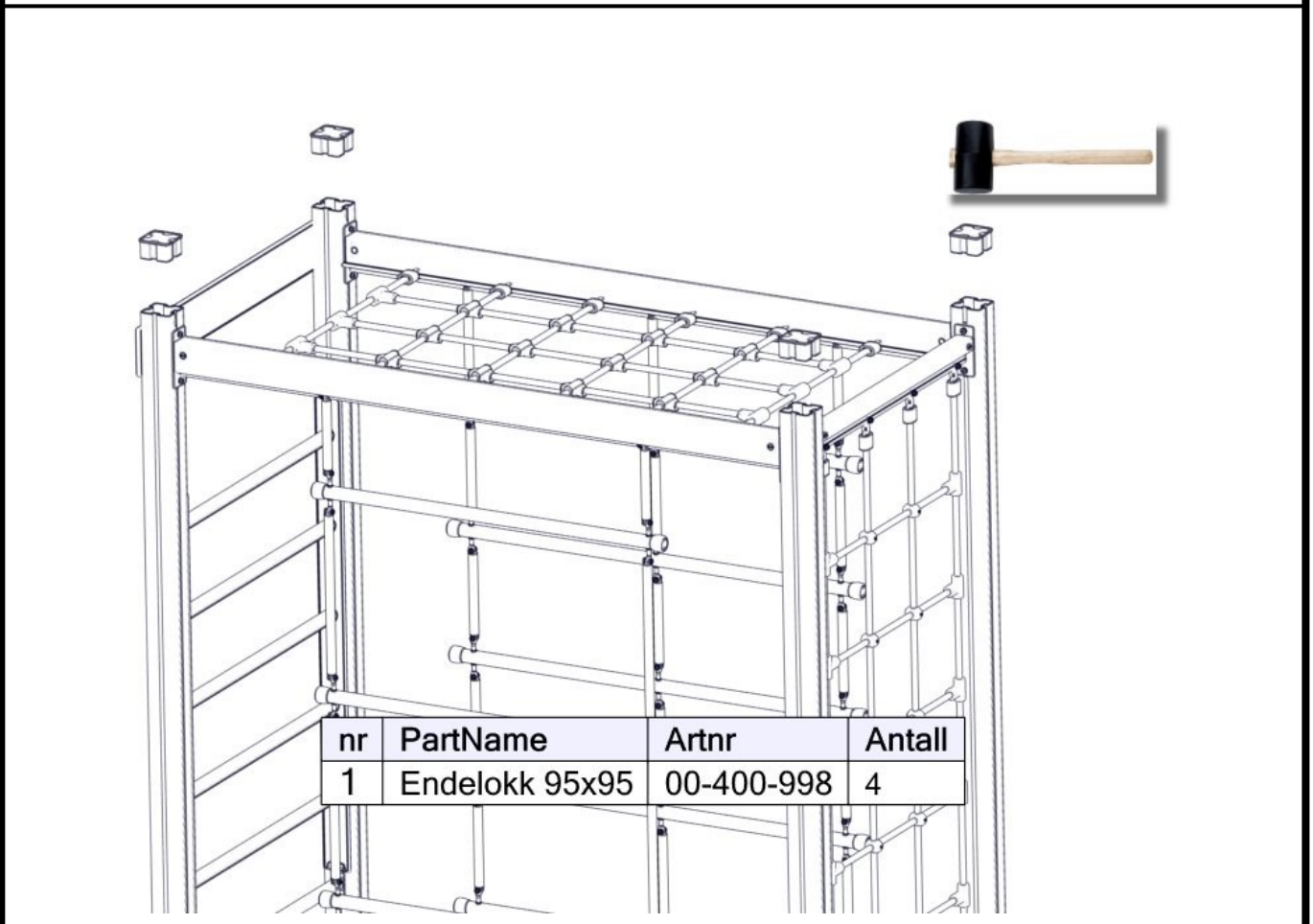
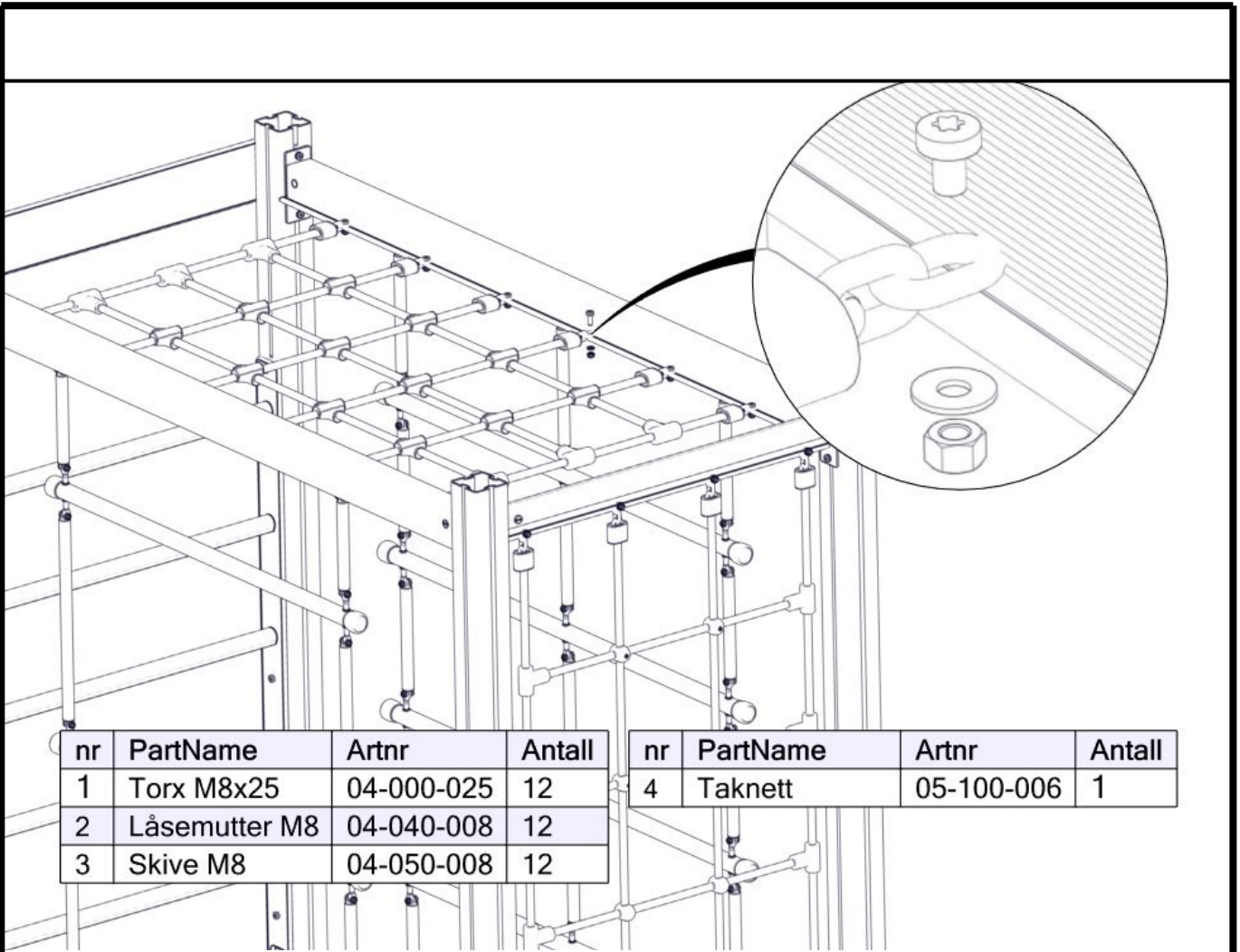







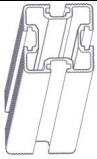

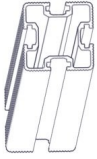
nr	PartName	Artnr	Antall
4	Skive M8 stor	04-055-008	2

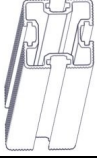

Før utstyret tas i bruk / Before play begins / Innan lekredskapet tas i bruk	
N	<ul style="list-style-type: none"> ● Påse at fallunderlag er utlagt i henhold til gjeldende regler eller vår anbefaling ● Fjern alle monteringshjelpemidler (rester av betong, planker, paller, plast, og lignende) ● Før utstyret tas i bruk, burde man sjekke at det ikke er fare for at anorakksnorer og lignende som kan hekte seg fast noen steder på lekeapparatet. (Vedlagte snor med dobbe (kneledd) kan brukes til å sjekke at dette er i orden. Se vedlagte veiledning for bruk av denne. Dette gjøres for å oppdage eventuelle feilmonteringer.?) ● NB! Bør stå i 2-3 dager før bruk
EN	<ul style="list-style-type: none"> ● Make sure the area and depth of safer surfacing are according to the current standard, or to the manufacturer's recommendation ● Make sure all tools and surplus materials are removed before play begins ● PS! When complete, allow 2-3 days for the concrete to set before use
S	<ul style="list-style-type: none"> ● Kontrollera att fallunderlag är utlagt enligt gällande regler eller vårt rekommendation ● Ta bort alla monteringshjälpmedel (rester av betong, plankor, pallar, plast och liknande) ● Innan lekredskapet används, kontrollera att anoracksnoddar eller kläder/delar av kläder eller liknande inte kan fastna i några delar på redskapet. (Den bipackade "knävringen" kan man med fördel användas för denna kontroll. ● Detta görs för att upptäcka eventuella felmonteringar.)

Boltepakker for / Boltpackage for / Bultpaket för

Sign. _____

Stolpe 95x95	Ant= 4	Navn	Artnr/dimensjon	Ant	Lev
		VK95 3230 800-2430 (1)	00-400-038	2	
		Stolp ende (1)	00-400-998	2	
Stolpe 95x95 med HPL	Ant= 1	Navn	Artnr/dimensjon	Ant	Lev
 Høyre		VK95 3230 800-2430 (1)	00-400-016	1	
		Stolp ende (1)	00-400-998	1	
Stolpe 95x95 med HPL	Ant= 1	Navn	Artnr/dimensjon	Ant	Lev
 Venstre		VK95 3030 600-2430 (1)	00-400-017	1	
		Stolp ende (1)	00-400-998	1	
Ribbevegge	Ant= 1	Navn	Artnr/dimensjon	Ant	Lev
		Sperrerør L=940	00-400-149(5)	5	
		Sperrerør med beslag	00-400-150(1)	1	
		Sprosse 1130x145x12 Svart	00-400-097(1)	1	
		Brikke_120_3T Brikke_150_3T Montert hos Søve	04-060-120(2) 04-060-150(2)	2 0	
		Torx M8x25 Torx M8x35	04-000-025 04-000-035	4 4	









Boltepakker for / Boltpackage for / Bultpaket för

Sign. _____

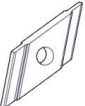
Drager	Ant= 1	Navn	Artnr/dimensjon	Ant	Lev
		Drager: L=1980 6 hull Horizontal 2 hull vertikal	00-400-859	1	
Drager	Ant= 2	Navn	Artnr/dimensjon	Ant	Lev
		Drager: L=1980 6 hull Horizontal 3 hull vertikal	00-400-857	1	
Drager	Ant= 1	Navn	Artnr/dimensjon	Ant	Lev
		Drager: L=940 4 hull vertikal	00-400-815	1	
Festemidler drager	Ant=	Navn	Artnr/dimensjon	Ant	Lev
		Brikke 180_3T Montert hos Søve	04-060-180	0	
		Brikke 160_2T	04-060-160	2	
		Torx M8x25	04-000-025	12	
	Skive M8	04-050-008	12		
Produktmerke	Ant= 1	Navn	Artnr/dimensjon	Ant	Lev
		Produktmerking Hos Søve	25-200-180	0	

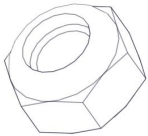
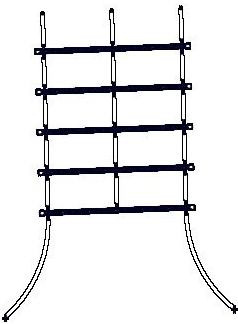

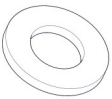



Boltepakker for / Boltpackage for / Bultpaket för

Sign. _____

M-nett	Ant= 1	Navn	Artnr/dimensjon	Ant	Lev
		M-Nett	05-079-014	1	
		Torx M8x25	04-000-025	6	
		Brikke skrå 15-1T	04-060-053	2	
		Skive M8	04-050-008	4	
		Låsemutter M8	04-040-008	4	
Æ-nett	Ant= 1	Navn	Artnr/dimensjon	Ant	Lev
		Æ-Nett	05-103-018	1	
		Torx M8x25 Torx M8x35	04-000-025 04-000-035	3 2	
		Brikke skrå 15-1T	04-060-053	2	
		Skive M8	04-050-008	5	
		Låsemutter M8	04-040-008	3	

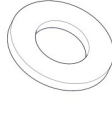
Boltepakker for / Boltpackage for / Bultpaket för

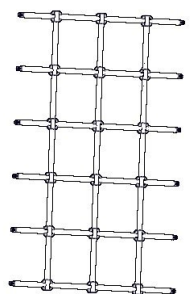
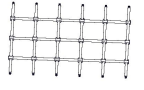
Sign. _____

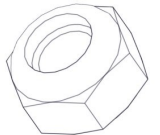
ÅÅ-nett	Ant= 1	Navn	Artnr/dimensjon	Ant	Lev
		ÅÅ-nett	05-103-016	1	
		Torx M8x25 (2) Torx M8x35(2)	04-000-025 04-000-035	2 2	
		Skive M8 (2) Skive M8 stor	04-050-008 04-055-008	2 2	
		Låsemutter M8 (4)	04-040-008	4	
		Fundamentplate (2)	00-003-103	2	
Tak--nett	Ant= 1	Navn	Artnr/dimensjon	Ant	Lev
		Tak-Nett	05-100-006	1	
		Torx M8x25	04-000-025	12	
		Skive M8	04-050-008	12	
		Låsemutter M8	04-040-008	12	

Boltepakker for / Boltpackage for / Bultpaket för

Sign. _____.

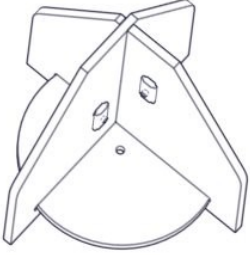
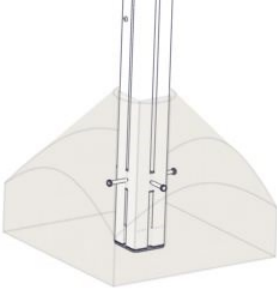
	Navn	Artnr/ dimensjon	Ant	Lev
	Fundament Nedgraving			
	Nedgravingsfundament Til 95x95 stolpe	00-003-004K	4	
	Fundament Støp			
	Fundament til støp Til 95x95 stolpe	00-003-110K	4	

Revidert

08-01-2020

Endret artikkel nr på sprosse ribbevegg og økte antall på fundament plate til åå-nett fra 1
til 2 stk

26-03-2020 MTK

Ny sikkerhetszone