

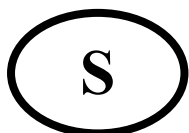

Monteringsanvisning



Assembly Instructions



Monteringsanvisning

Produkt nr. / Product no. / Produkt nr.

31-400-085

Ordr. nr. _____

Dato. _____

Sign. _____

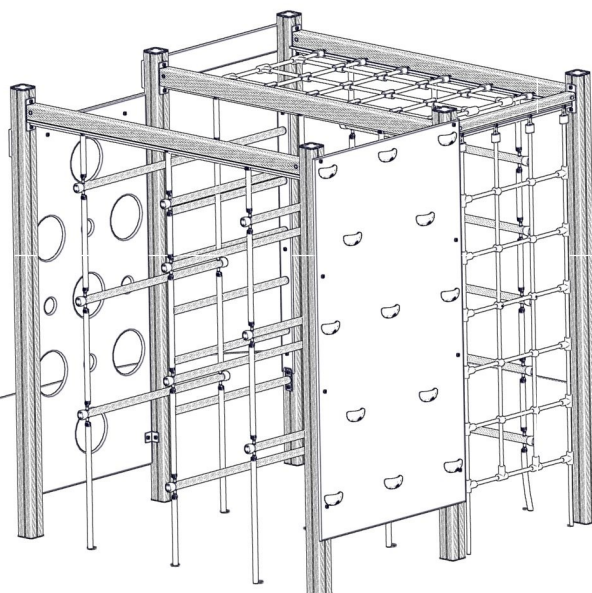

søve

Søve AS
Grønnvoldveien 290
3830 Ulefoss - Norway
Tlf: +47 35 94 65 65
www.sove.no



søve

Søve AB
EA Rosengrensgatan 32
421 31 Västra Frölunda
Phone: +46 (0)31 773 97 00
www.sove.se

Monteringstips / Assembly Advice / Monteringsstips**N**

- Les monteringsanvisningen nøye før montering.
- Monter elementene i rekkefølgen som vist.
- Boltene bør ikke skrues for hardt til før alt er montert, vatret og loddet. Skru så boltene til.
- NB! Ved bruk av drill, kan boltene ryke.
- På grunn av at solen kan gjøre rutsjeplaten veldig varm, bør rutsjebanens utløp vende mot nord-øst eller nord-vest.
- Er lekeutstyret plassert i naturlige ferdselstraséer må området sikres mot gjennomgang.
- Innspringningshinder bør vurderes rundt lekeapparater hvor det er stor bevegelse, f.eks. ved huskestativ.
- Det bør være fritt innsyn til lekeutstyr som er beregnet for barn under 3 år.

NB! Under monteringsarbeidet må utstyr, som ikke er forankret forsvarlig i bakken, sikres slik at det ikke velte.

Området må avstenges under montering av apparatene med sperrebånd eller lignende.

EN

- Read the instruction carefully before assembling the play unit.
- Assemble the components in the sequence shown in these instructions. Fixings must not be fully tightened during assembly. Before casting the foundations, the structure must be level and plumb, at which point all fixings are tightened. PSI If use of drill, the bolts may be wrecked.
- Avoid positioning the slide facing due south because of overheating – ideal positions are facing north-east or north-west. Secure the construction-area to prevent people from walking through it.
- Consider installing barriers around play-equipment which gives rise to a lot of activity – i.e. swings.
- Ensure that clear vision is possible across the play area so that supervision is possible from any position, particularly where children under 3 years of age will be playing.

NB! During assembly of the equipment, ensure that all structures are securely propped, especially when left overnight. Also ensure that equipment is supported

Monteringstips / Assembly Advice / Monteringsstips**S**

- Läs monteringsanvisningen noga före montering.

- Montera delarna i den ordningen som anvisas
- Skruvarna bör inte skruvas för hårt tills allt är monterat, i våg och lodat.









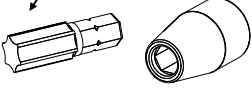

OBS! Används elektrisk skruvdragare, kan bulten gå sönder. Hårdra därför manuellt!

- Solen kan göra att rutchbanan blir väldigt varm. Banans nedfart rekommenderas att vändas i norrlig riktning
- Om lekplatsen placeras vid en gångväg mm bör området säkras mot genomfart av gående och cyklister.
- Insprängningshinder bör placeras runt lekutrustning med stor rörelse, t ex, gungställning.
- Det bör vara fri insyn till lekutrustning beräknat till barn under 3 år.

OBS! Under monteringsarbete bör utrustningen som inte ska förankras i marken, ställs så att den inte kan välta.

Området måste spärras när lekutrustningen byggs upp, med avspärrningsband eller liknande.

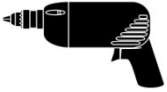
Nødvendig verktøy / Tools required / Nödvändiga verktyg

| | | | | | |
|-----------------------------------|--|---|---|--|--|
| <p>(N)</p> <p>(EN)</p> <p>(S)</p> | <p>(A)</p>  | <p>(B)</p>  <p>Torx Nr 45 High quality</p>  | <p>(C)</p> <p>5 mm 6 mm</p>  | <p>(D)</p>  | <p>(E)</p>  |
| |  | <p>Metermål Metric measure Tumstock</p>  | <p>16 V</p>  | <p>Merkebånd Mark ribbon Märkeband</p>  | <p>13 + 17mm</p>  |

Nødvendig antall personer / Number of persons required / Rekommenderad antal personer





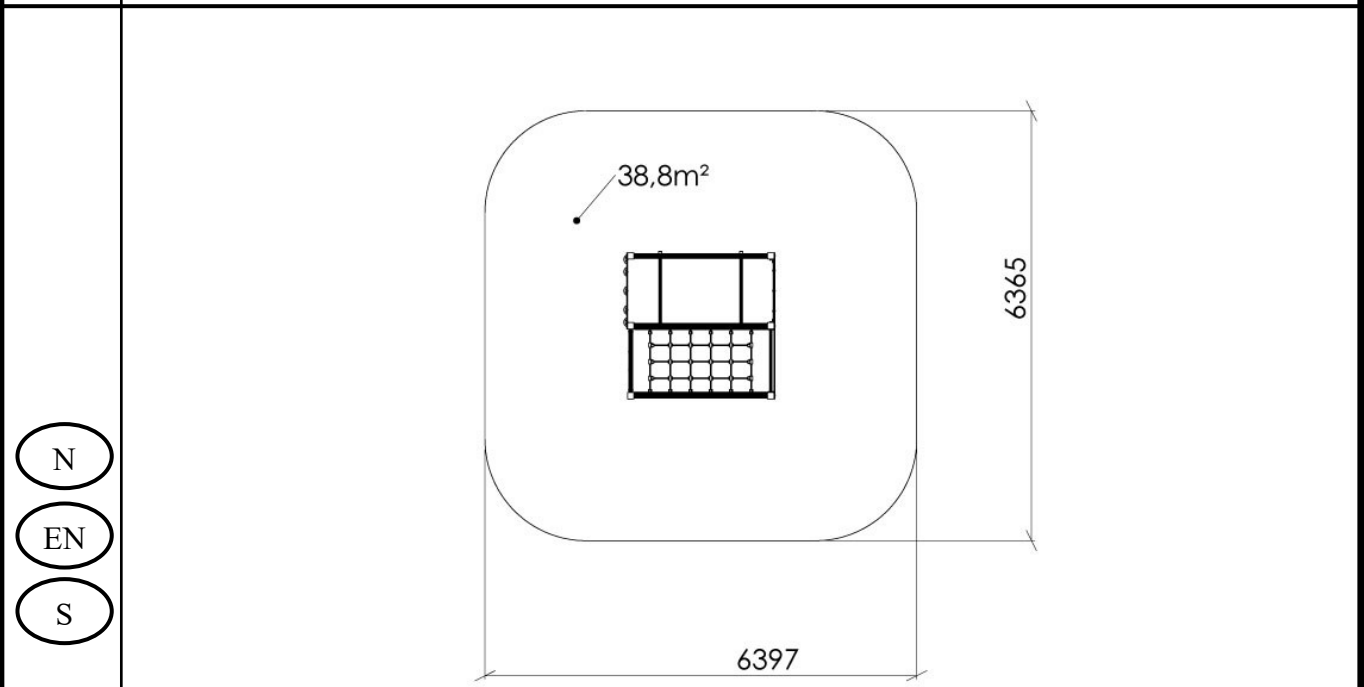





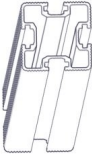

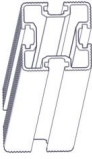

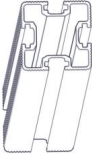
Anbefalt arealbehov ved montering / Recommended working space / Rekommenderad arealbehov vid montering



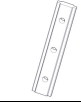

Boltepakker for / Boltpackage for / Bultpaket för

Sign. _____

| Stolpe 95x95 | Ant= 4 | Navn | Artnr/dimensjon | Ant | Lev |
|---|---|---------------------------------|--------------------------------|------------|------------|
|  |  | VK95 3030 600-2430 (1) | 00-400-038 | 4 | |
| | | Stolp ende (1) | 00-400-998 | 4 | |
| Stolpe 95x95 med HPL | Ant= 1 | Navn | Artnr/dimensjon | Ant | Lev |
|  Høyre |  | VK95 3030 600-2430 (1) | 00-400-016 | 1 | |
| | | Stolp ende (1) | 00-400-998 | 1 | |
| Stolpe 95x95 med HPL | Ant= 1 | Navn | Artnr/dimensjon | Ant | Lev |
|  Venstre |  | VK95 3030 600-2430 (1) | 00-400-017 | 1 | |
| | | Stolp ende (1) | 00-400-998 | 1 | |
| Ribbevegge | Ant= 1 | Navn | Artnr/dimensjon | Ant | Lev |
|  |  | Sperrerør L=940 | 00-400-149(5) | 5 | |
| |  | Sperrerør med beslag | 00-400-150(1) | 1 | |
| |  | Sprosse 1130x145x12 Svart | 00-400-102(1) | 1 | |
| |  | Brikke_120_3T Brikke_150_3T | 04-060-120(2) 04-060-150(2) | 2 2 | |
| |  | Torx M8x25 Torx M8x35 | 04-000-025 04-000-035 | 4 4 | |



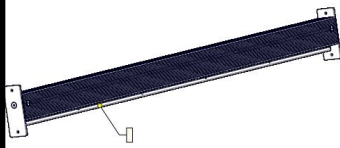
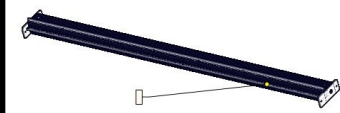
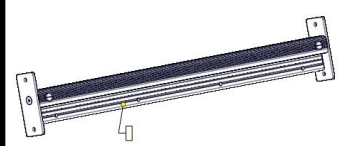





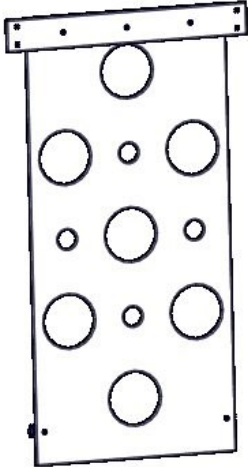

Boltepakker for / Boltpackage for / Bultpaket för

Sign. _____

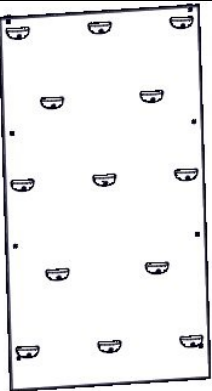
| Drager | Ant= 1 | Navn | Artnr/dimensjon | Ant | Lev |
|---|---|--|-----------------|-----|-----|
|  | | Drager: L=1980 3 hull Vertikal | 00-400-858 | 1 | |
| Drager | Ant= 2 | Navn | Artnr/dimensjon | Ant | Lev |
|  | | Drager: L=1980 6 hull Horizontal 3 hull vertikal | 00-400-857 | 2 | |
| Drager | Ant= 1 | Navn | Artnr/dimensjon | Ant | Lev |
|  | | Drager: L=940 4 hull vertikal | 00-400-815 | 1 | |
| Festemidler drager | Ant= | Navn | Artnr/dimensjon | Ant | Lev |
|  |  | Brikke 180_3T | 04-060-180 | 6 | |
| | | Brikke 160_2T | 04-060-160 | 2 | |
| | | Torx M8x25 | 04-000-025 | 16 | |
| Produktmerke | Ant= 1 | Navn | Artnr/dimensjon | Ant | Lev |
|  | | Produktmerking Hos Søve | 25-200-180 | 0 | |

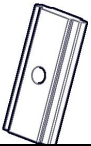
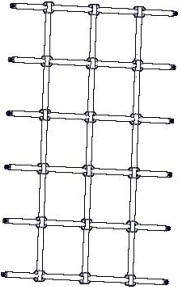







Boltepakker for / Boltpackage for / Bultpaket för

Sign. _____

| Klatrevegge med hull | Ant= 1 | Navn | Artnr/dimensjon | Ant | Lev |
|---|---|--|--|-------------|------------|
|  | | Klatrevegge | 00-400-750 | 1 | |
| |  | Torx M8x35 Torx M8x25 Torx M8x12 | 04-000-035 04-000-025 04-000-012 | 4 2 2 | |
| |  | Brikke 150_3T Brikke 50-1T | 04-060-150 04-060-050 | 2 2 | |
| |  | Vinkel 50x50x4 | 04-070-036 | 2 | |
| |  | Møbelknapp | 04-030-016 | 2 | |
| Klatrevegge med gripp | Ant= 1 | Navn | Artnr/dimensjon | Ant | Lev |
|  | | Klatrevegge | 00-400-720 | 1 | |
| |  | Torx M8x35 | 04-000-035 | 8 | |
| |  | Brikke 50-1T | 04-060-050 | 8 | |
| Tak--nett | Ant= 1 | Navn | Artnr/dimensjon | Ant | Lev |
|  |  | Tak-Nett | 05-100-006 | 1 | |
| |  | Torx M8x25 | 04-000-025 | 12 | |
| |  | Skive M8 | 04-050-008 | 12 | |
| |  | Låssemutter M8 | 04-040-008 | 12 | |

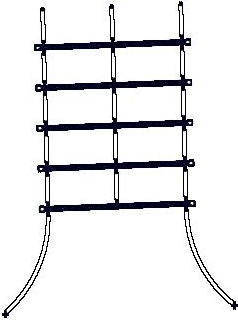

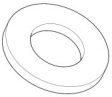





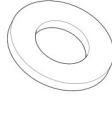

Boltepakker for / Boltpackage for / Bultpaket för

Sign. _____

| M-nett | Ant= 1 | Navn | Artnr/dimensjon | Ant | Lev |
|---|---|--------------------------|--------------------------|--------|-----|
|  | | M-Nett | 05-079-014 | 1 | |
| |  | Torx M8x25 Torx M8x35 | 04-000-025 04-000-035 | 4 2 | |
| |  | Brikke 50-1T | 04-060-050 | 2 | |
| |  | Skive M8 | 04-050-008 | 6 | |
| |  | Låsemutter M8 | 04-040-008 | 4 | |
| Æ-nett | Ant= 1 | Navn | Artnr/dimensjon | Ant | Lev |
|  | | Æ-Nett | 05-103-018 | 1 | |
| |  | Torx M8x25 Torx M8x35 | 04-000-025 04-000-035 | 3 2 | |
| |  | Brikke 50-1T | 04-060-050 | 2 | |
| |  | Skive M8 | 04-050-008 | 5 | |
| |  | Låsemutter M8 | 04-040-008 | 3 | |



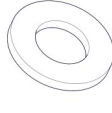

Boltepakker for / Boltpackage for / Bultpaket för

Sign. _____

| ÅÅ-nett | Ant= 2 | Navn | Artnr/dimensjon | Ant | Lev |
|---|---|---------------------------------|--------------------------|--------|-----|
|  |  | ÅÅ-nett | 05-103-017 | 2 | |
| |  | Torx M8x25 (2) Torx M8x35(2) | 04-000-025 04-000-035 | 4 4 | |
| |  | Skive M8 (2) | 04-050-008 | 4 | |
| |  | Låsemutter M8 (4) | 04-040-008 | 8 | |
| |  | Fundamentplate (2) | 00-003-106 | 4 | |
| Å-nett | Ant= 1 | Navn | Artnr/dimensjon | Ant | Lev |
|  |  | Å-nett | 05-103-018 | 1 | |
| |  | Torx M8x25 (2) Torx M8x35(2) | 04-000-025 04-000-035 | 2 2 | |
| |  | Skive M8(4) | 04-050-008 | 4 | |
| |  | Låsemutter M8 (4) | 04-040-008 | 4 | |
| |  | Fundamentplate(2) | 00-003-106 | 2 | |

Boltepakker for / Boltpackage for / Bultpaket för

Sign. _____.

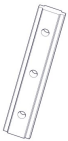
| Fundament | Ant= 6 | Navn | Artnr/dimensjon | Ant | Lev |
|-----------|---|--|-----------------|-----|-----|
| |  | Fundament plate(1) | 00-003-010 | 6 | |
| |  | Fundamentdel1 (1) 4x med VK70 hull 1x med VK95 hull | 00-003-010 | 6 | |
| |  | Fundament del2 (1) 4x med VK70 hull 1x med VK95 hull | 00-003-010 | 6 | |
| |  | Torx M8x35(3) | 04-000-035 | 18 | |
| |  | Brikke 120 3T (2) | 04-060-120 | 12 | |

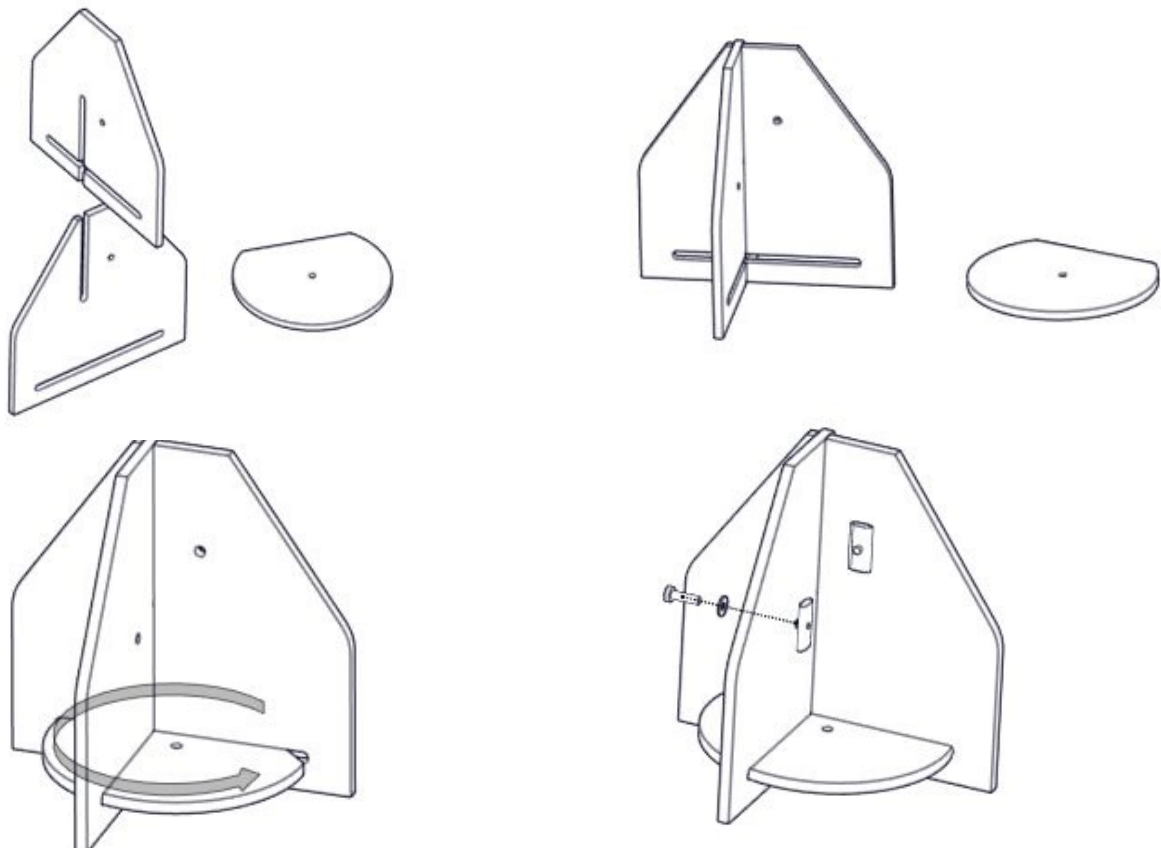

Fundamentering med betong // Foundation concrete // Förankring med betong

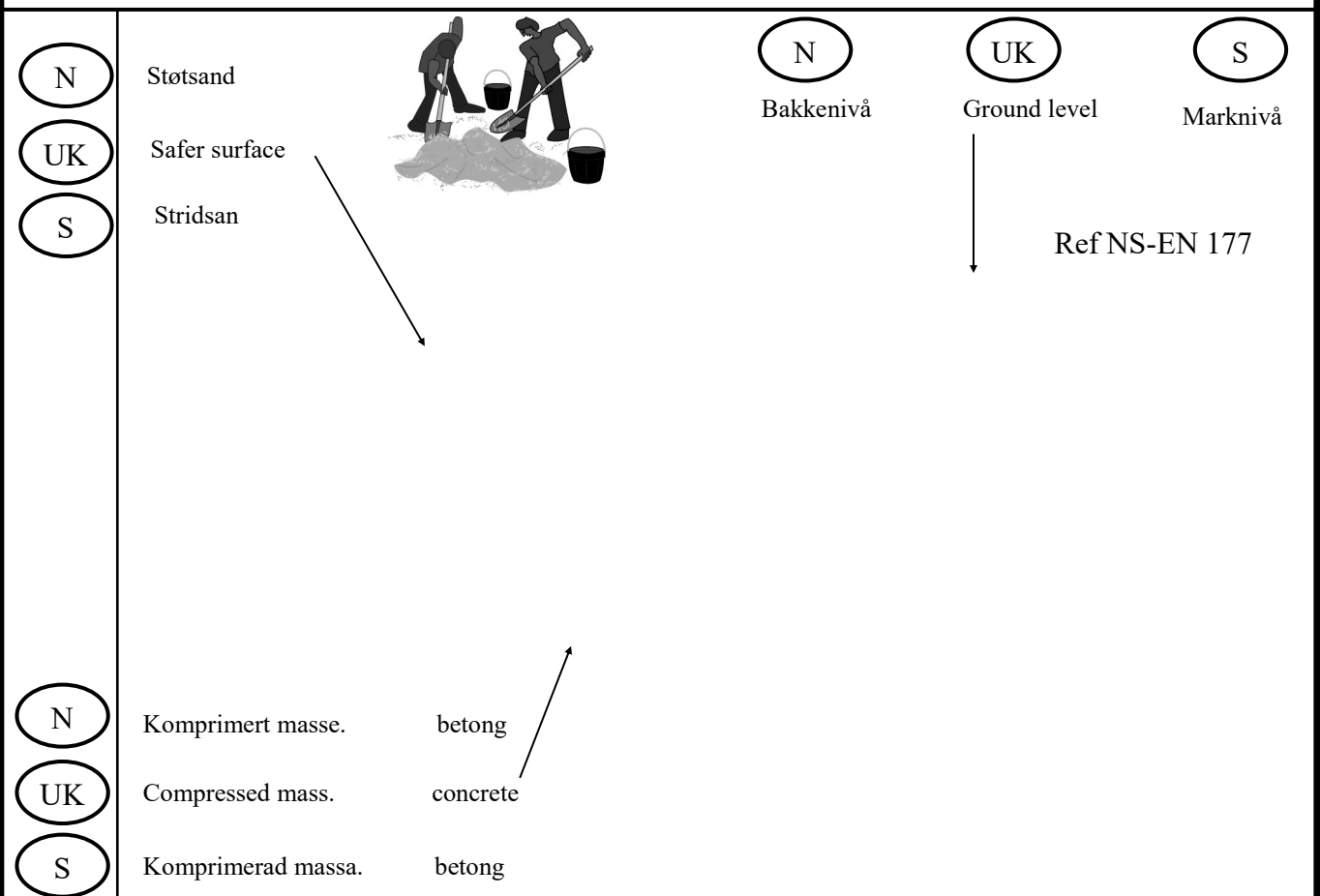

Fundamentering uten betong // Foundation without concrete // Förankring utan betong

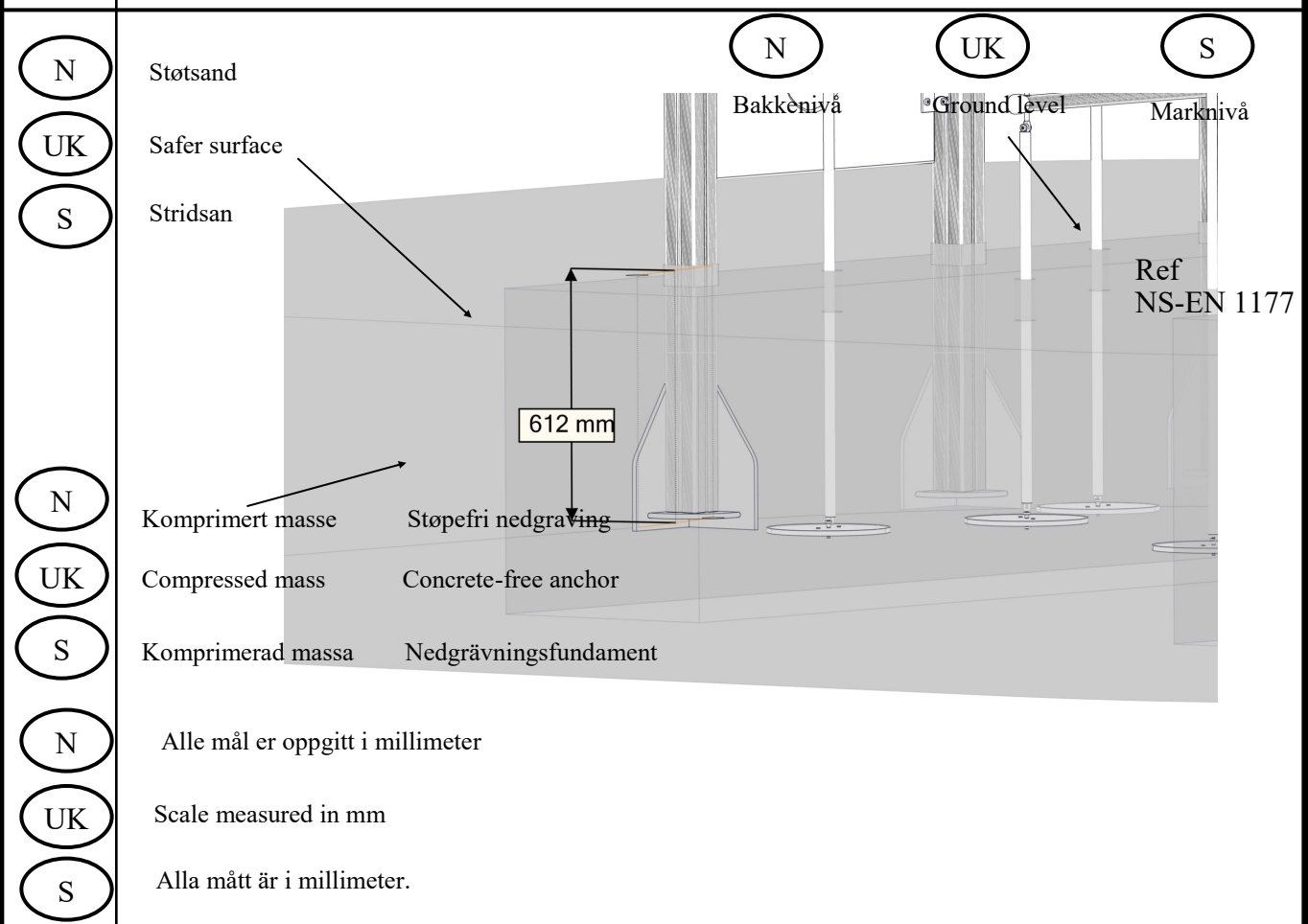

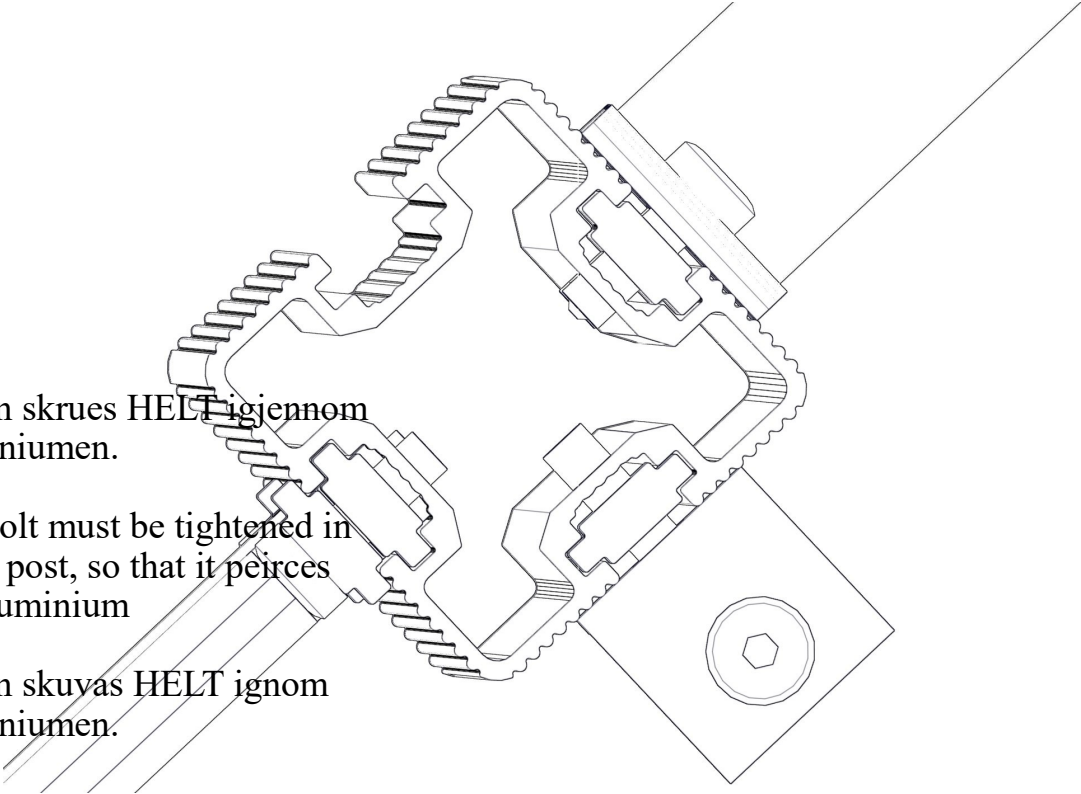
| | |
|---|--|
| | |
| | |
| <p data-bbox="124 1563 220 1630">N</p> <p data-bbox="124 1697 220 1765">UK</p> <p data-bbox="124 1854 220 1921">S</p> |  <p data-bbox="240 1585 703 1659">Bolten skrues HELT igjennom aluminiumen.</p> <p data-bbox="240 1704 687 1816">The bolt must be tightened in to the post, so that it pierces the aluminium</p> <p data-bbox="240 1861 663 1935">Bulten skruvas HELT igjennom aluminiumen.</p> |

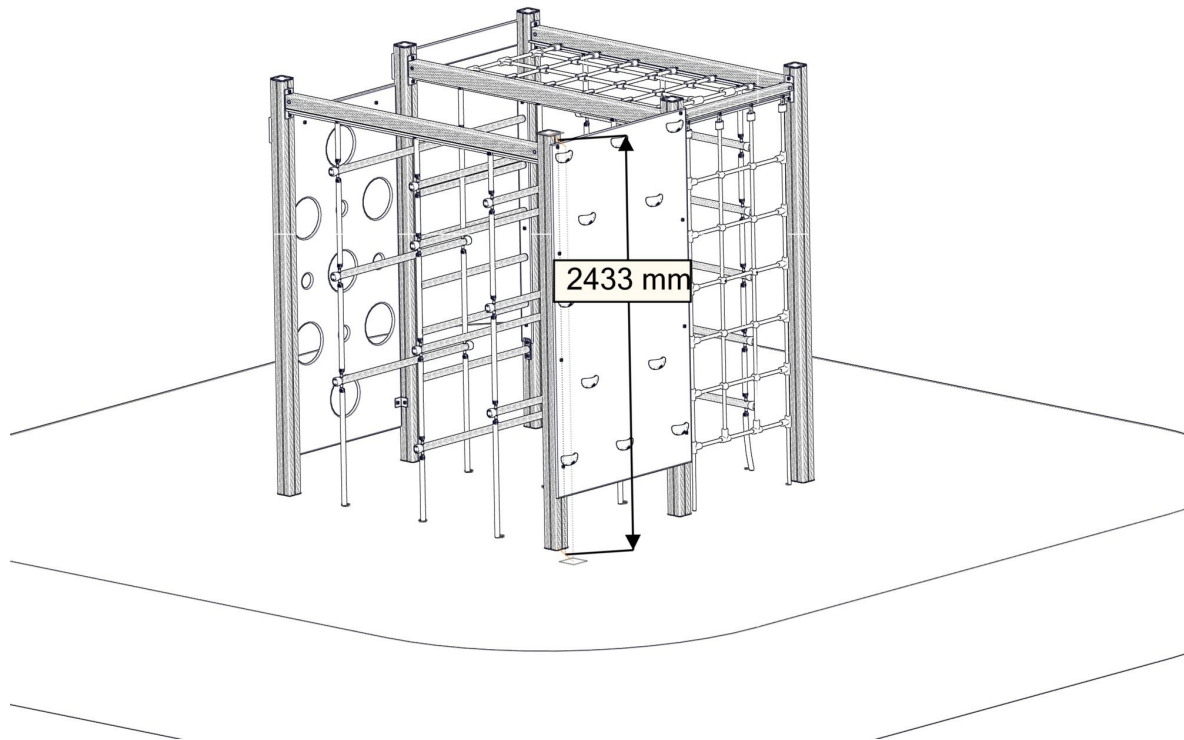
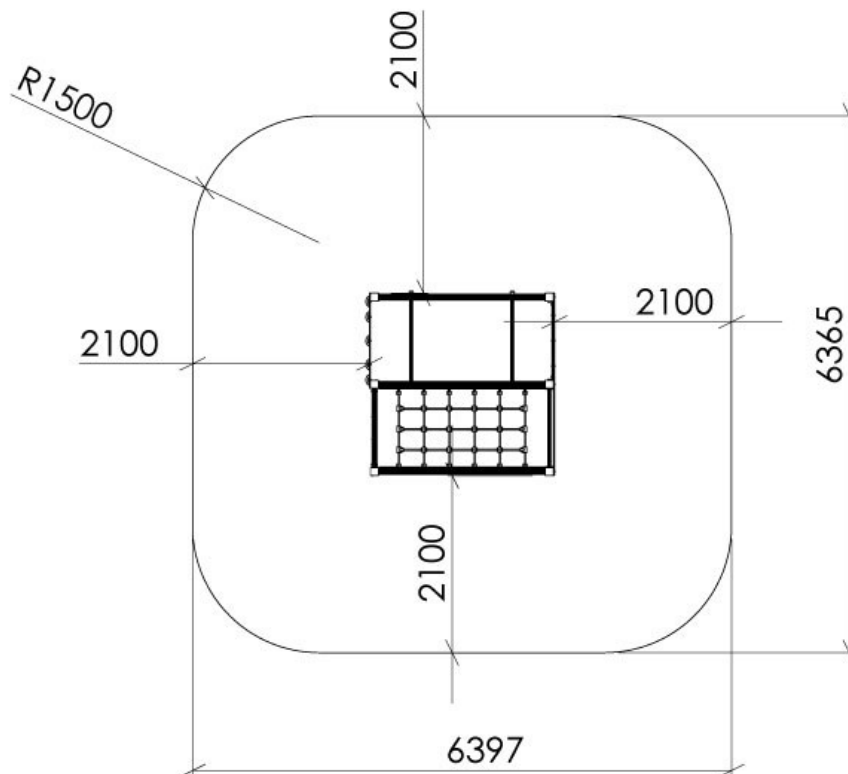
Fallhøyder / Free height of fall / Fallhöjder**Sikkerhetszone / Safety zone / Säkerhetszon**

Plassering av forankringer / Ground plan / Placering av förankringar

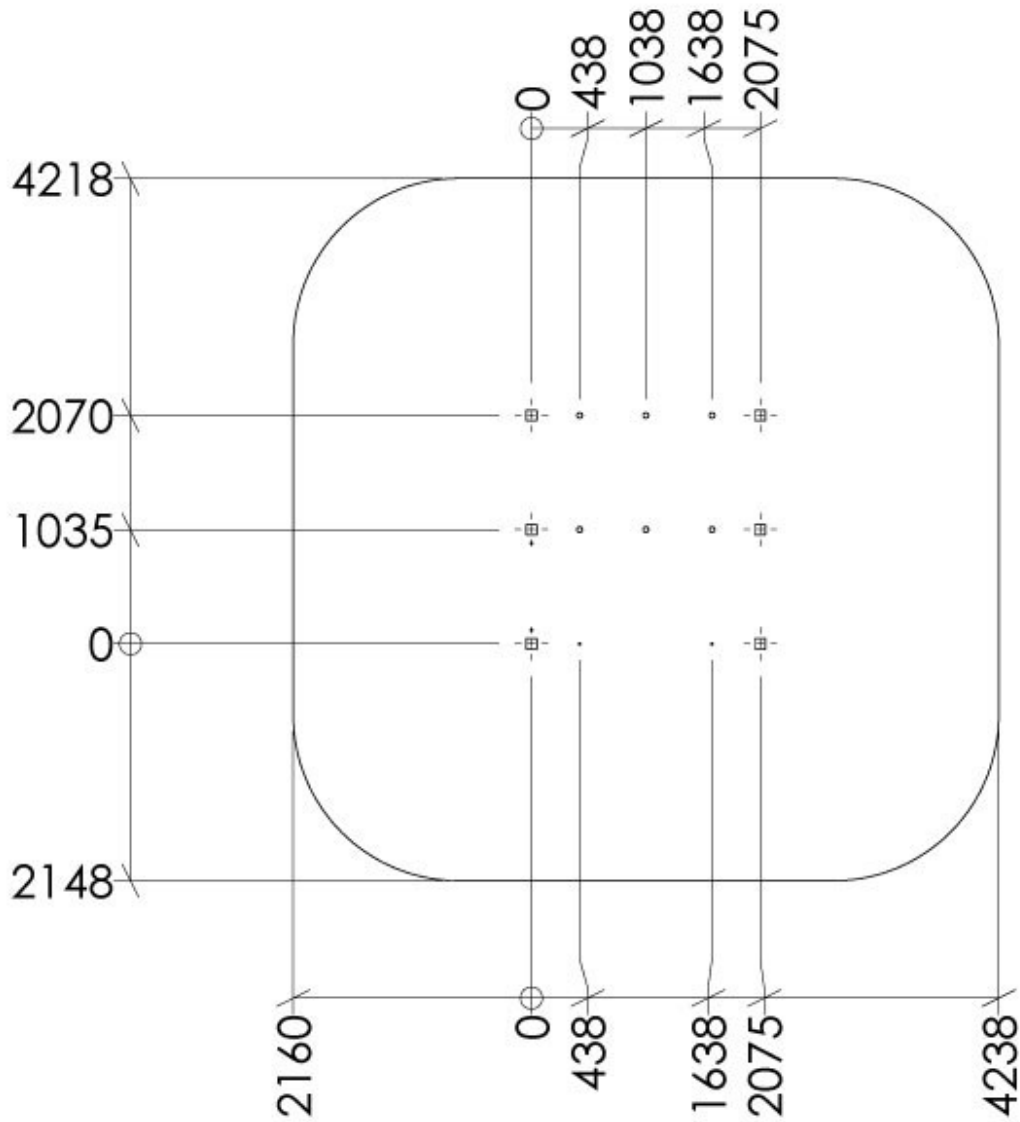

N

Alle mål er oppgitt i millimeter

UK

Scale measured in mm

S

Alla mått är i millimeter.

Montering av lekeapparatet / Assembly instructions / Montering av lekredskapet

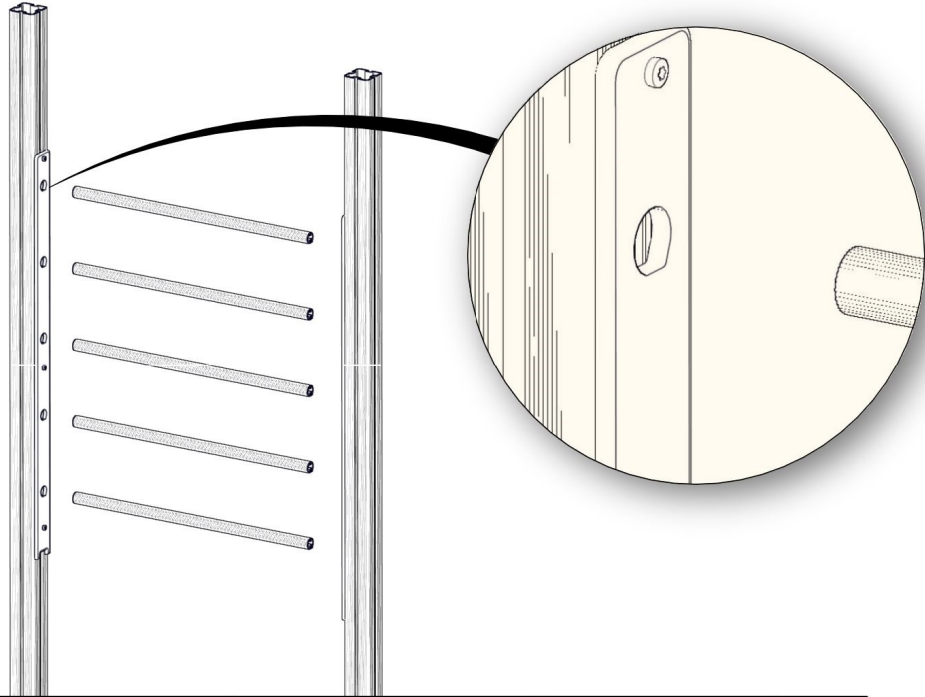

| BOM ID | Name | SW Configuration | Artnr (config) | Qty |
|--------|---------------------|------------------|----------------|-----|
| 1 | RibbeveggRorfeste-2 | Motast | 00-400-016 | 1 |
| 2 | RibbeveggRorfeste-1 | Default | 00-400-017 | 1 |
| 3 | SFA_5108a- | 940 | 00-400-149 | 5 |

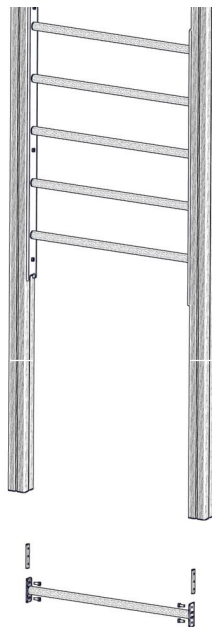

| BOM ID | Name | SW Configuration | Artnr (config) | Qty |
|--------|-------------------|------------------|----------------|-----|
| 1 | brikke_SFA5116-1 | 120_3T | 04-060-120 | 2 |
| 2 | Sperror_SFA5110-1 | 940-12 | 07-150-062 | 1 |
| 3 | TorxM8- | TXM8x25 | 04-000-025 | 4 |

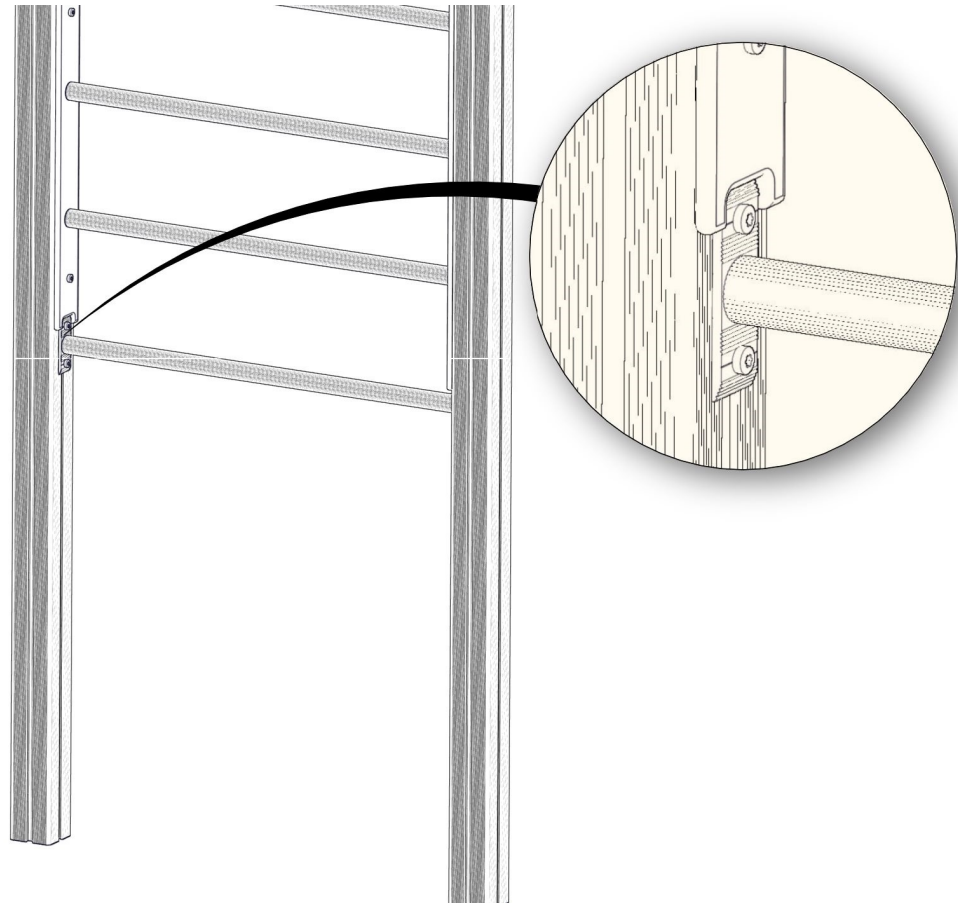
Montering av lekeapparatet / Assembly instructions / Montering av lekredskapet



| BOM ID | Name | SW Configuration | Artnr (config) | Qty |
|--------|-----------------------|------------------|----------------|-----|
| 1 | brikke_SFA5116-1 | 150-3T | 04-060-150 | 2 |
| 2 | Sprosse_1130x145x12-1 | UteHull | 00-400-102 | 1 |
| 3 | TorxM8- | TXM8x35 | 04-000-035 | 4 |

6x

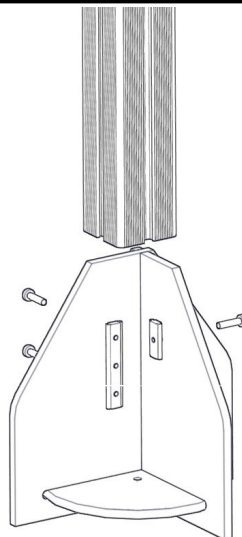

| BOM ID | Name | SW Configuration | Artnr (config) | Qty |
|--------|------------------|------------------|----------------|-----|
| 1 | VK95_SFA5117_A-1 | 600-2430 | 00-400-038 | 1 |
| 8 | Fun_VK95_ | Default | 00-003-10 | 3 |
| 9 | TorxM8- | TXM8x35 | 04-000-035 | 3 |
| 10 | Skive- | M8_stor | 04-055-008 | 3 |
| 11 | brikke_SFA5116-2 | 50_1T | 04-060-050 | 1 |
| 12 | brikke_SFA5116-1 | 120_3T | 04-060-120 | 1 |

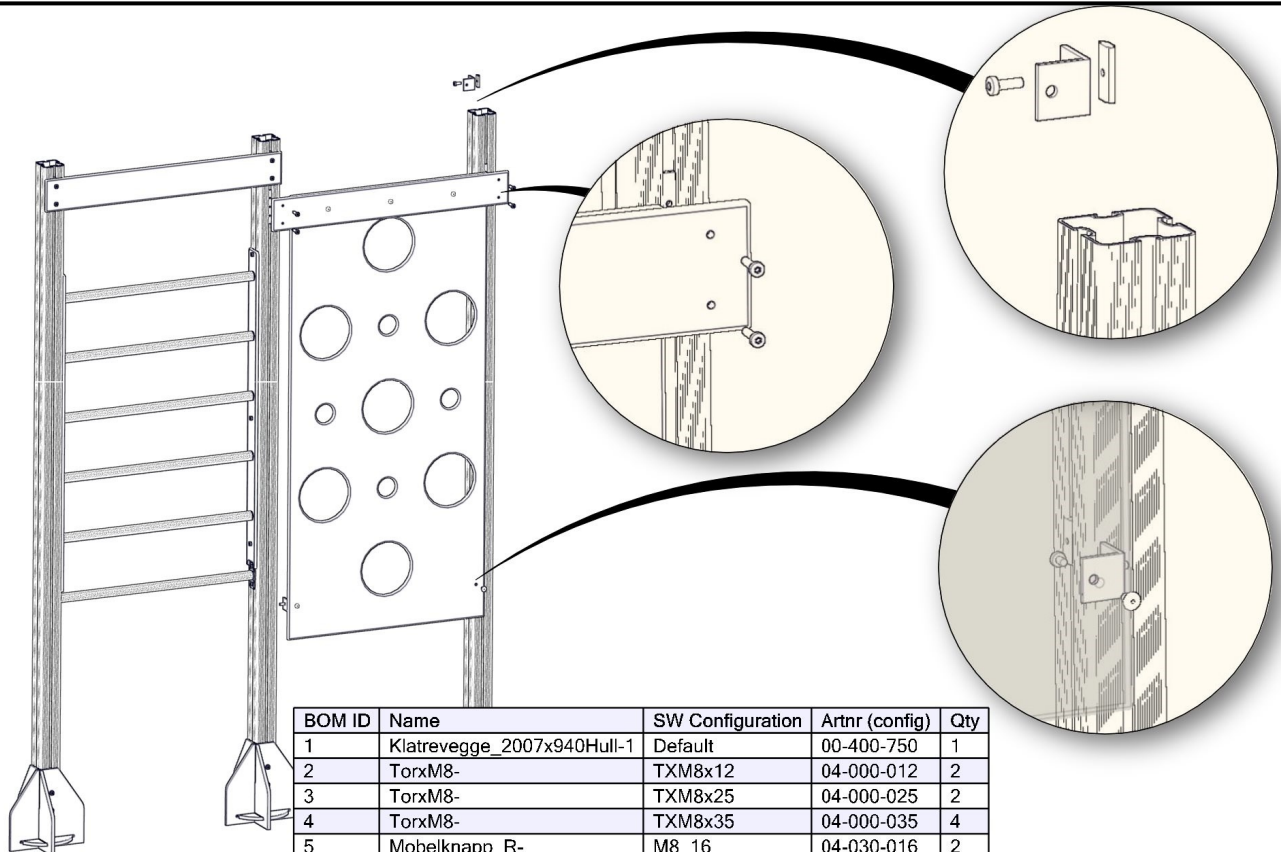
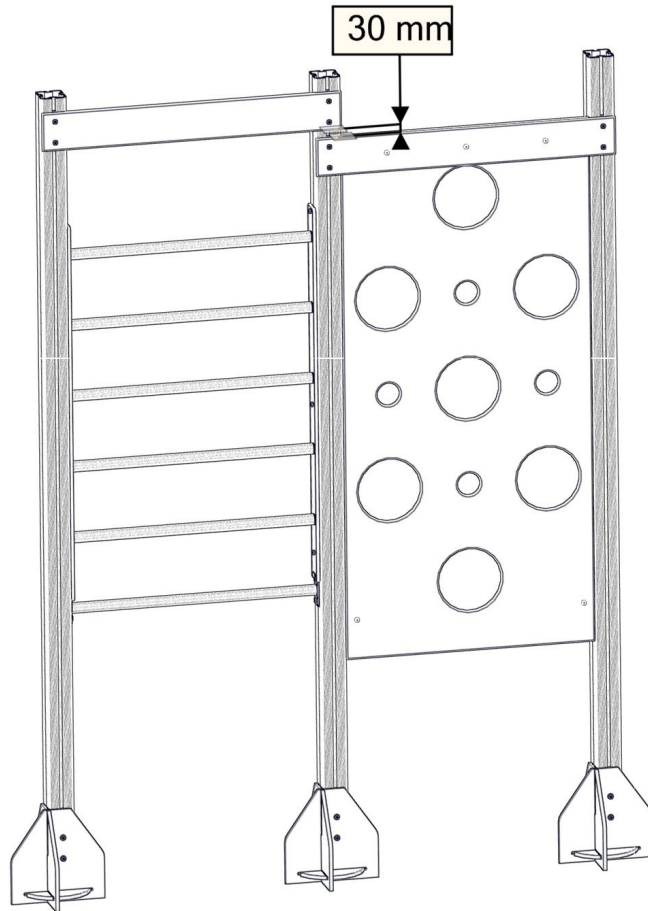

| BOM ID | Name | SW Configuration | Artnr (config) | Qty |
|--------|----------------------------|------------------|----------------|-----|
| 1 | Klatrevegge_2007x940Hull-1 | Default | 00-400-750 | 1 |
| 2 | TorxM8- | TXM8x12 | 04-000-012 | 2 |
| 3 | TorxM8- | TXM8x25 | 04-000-025 | 2 |
| 4 | TorxM8- | TXM8x35 | 04-000-035 | 4 |
| 5 | Mobelknapp_R- | M8_16 | 04-030-016 | 2 |
| 6 | brikke_SFA5116- | 50_1T | 04-060-050 | 2 |
| 7 | 50x50x5- | 11mm | 04-070-050 | 2 |

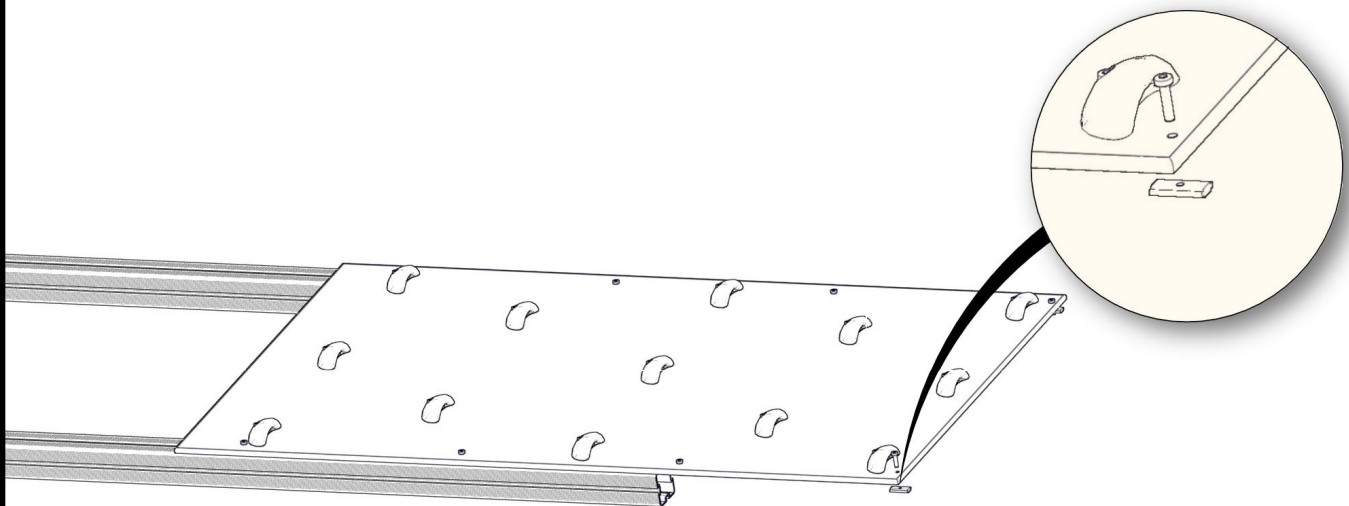
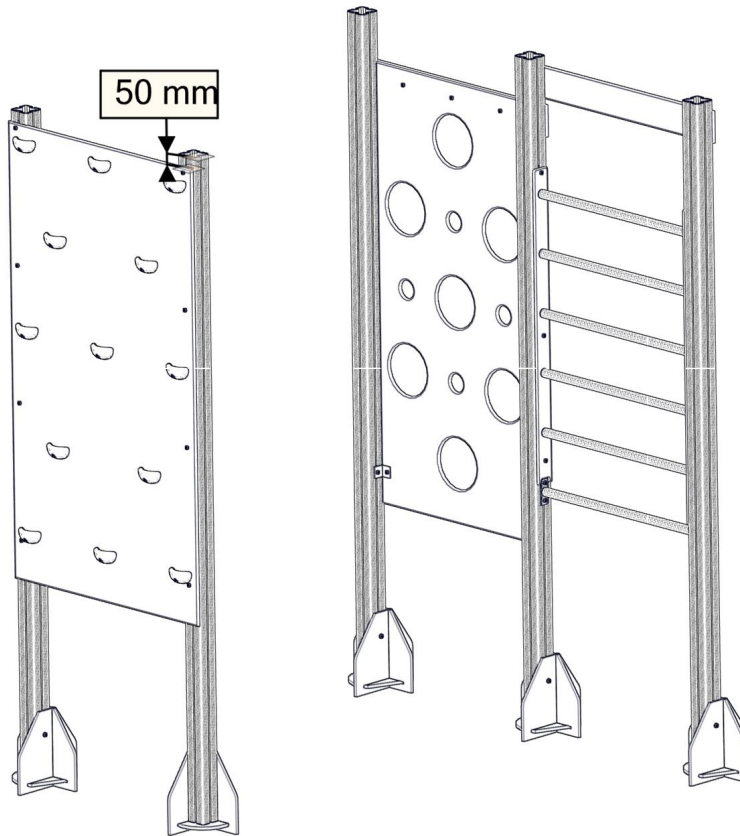

| BOM ID | Name | SW Configuration | Artnr (config) | Qty |
|--------|-------------------------|------------------|----------------|-----|
| 1 | Klatrevegge_2075x1130-1 | Default | 00-400-720 | 1 |
| 2 | TorxM8-1 | TXM8x35 | 04-000-035 | 8 |
| 3 | brikke_SFA5116-1 | 50_1T | 04-060-050 | 8 |

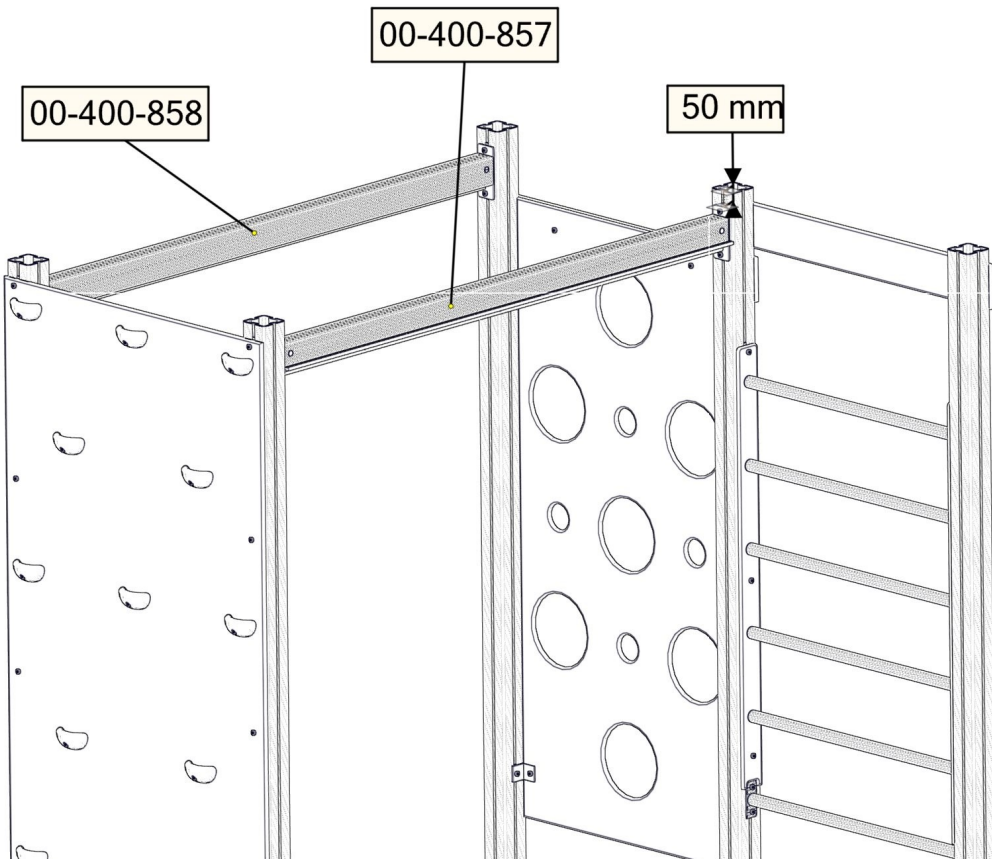
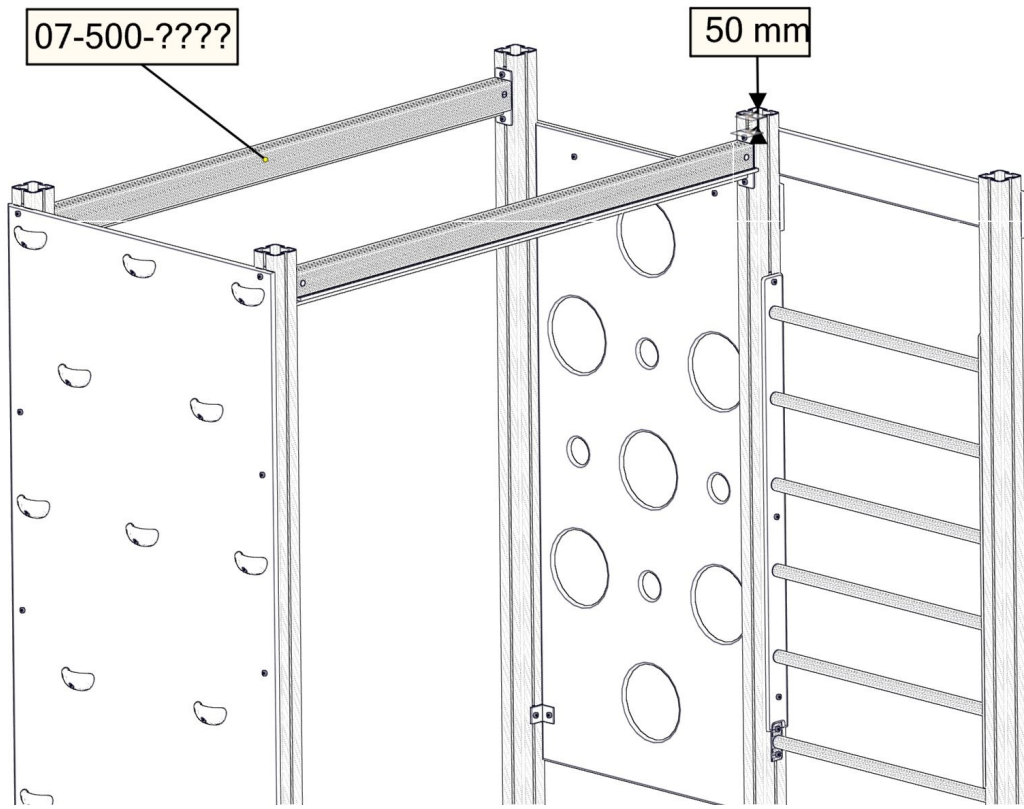

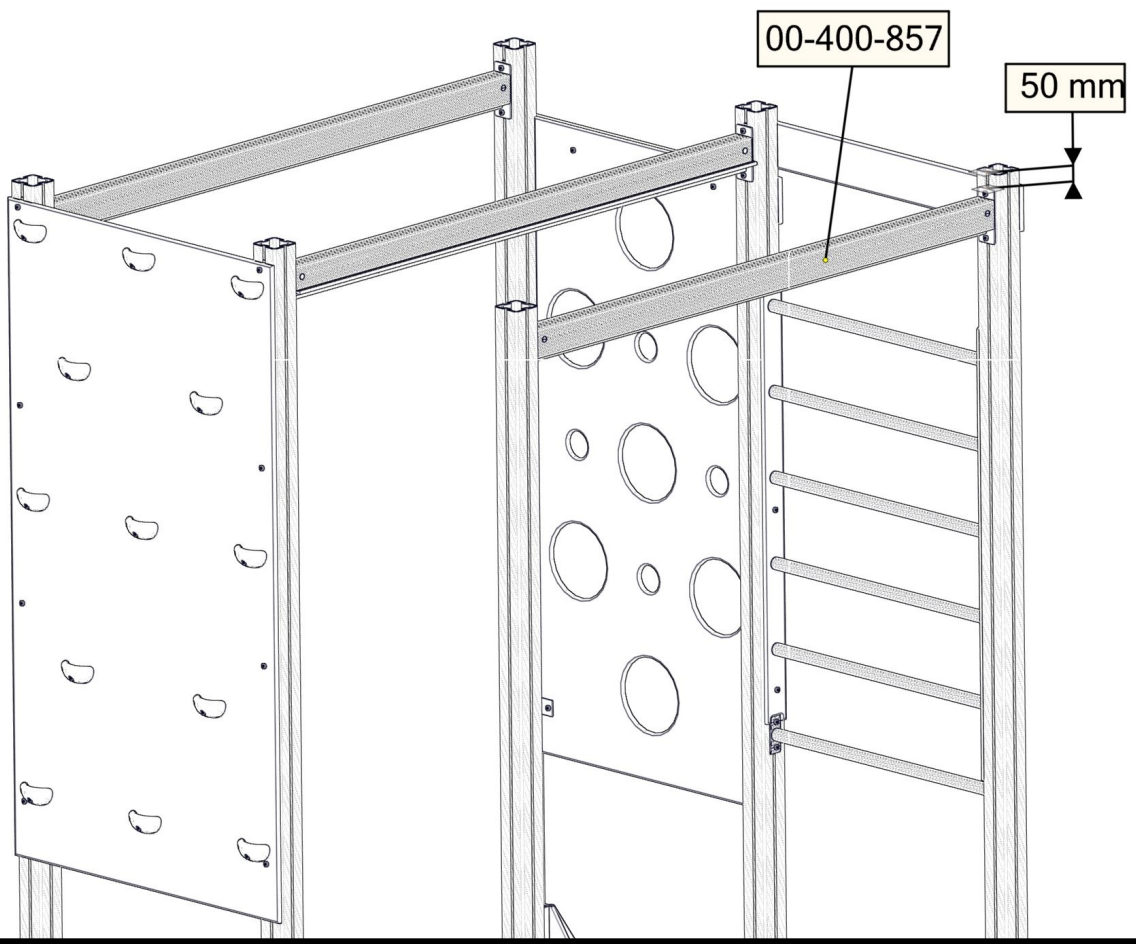
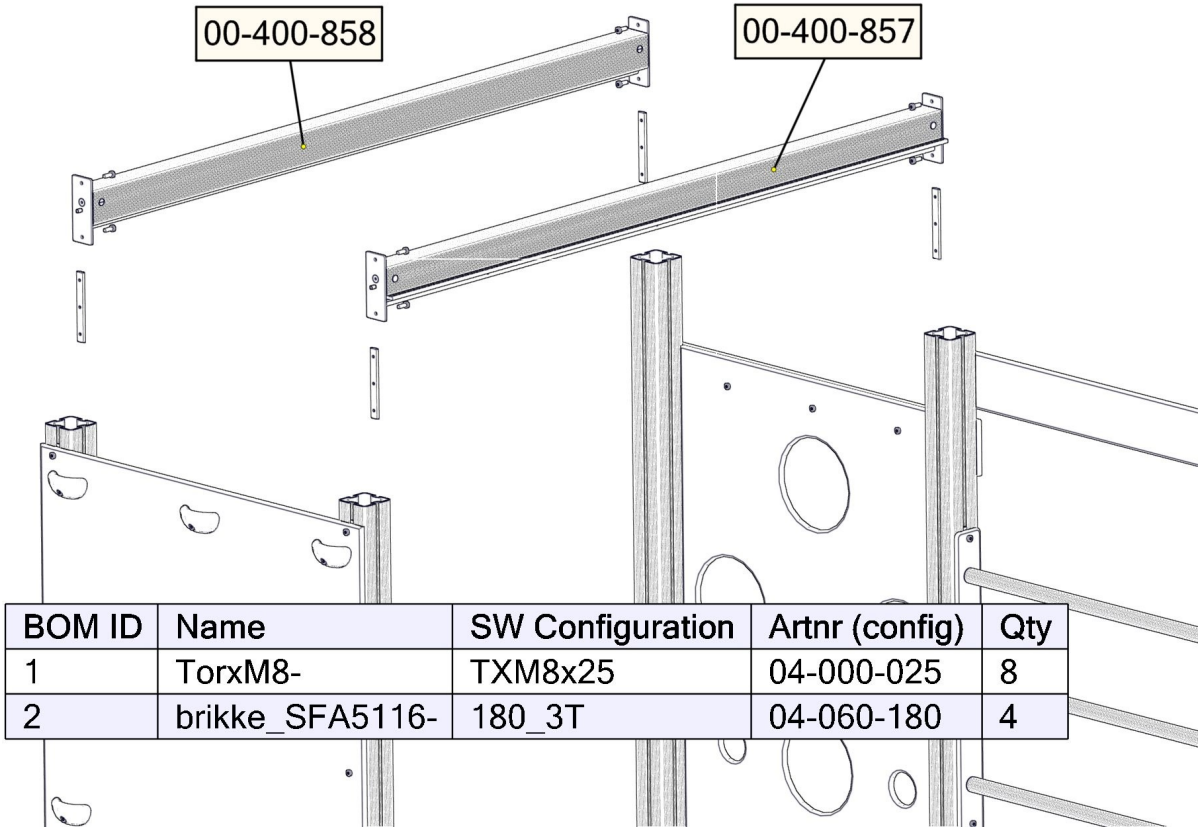

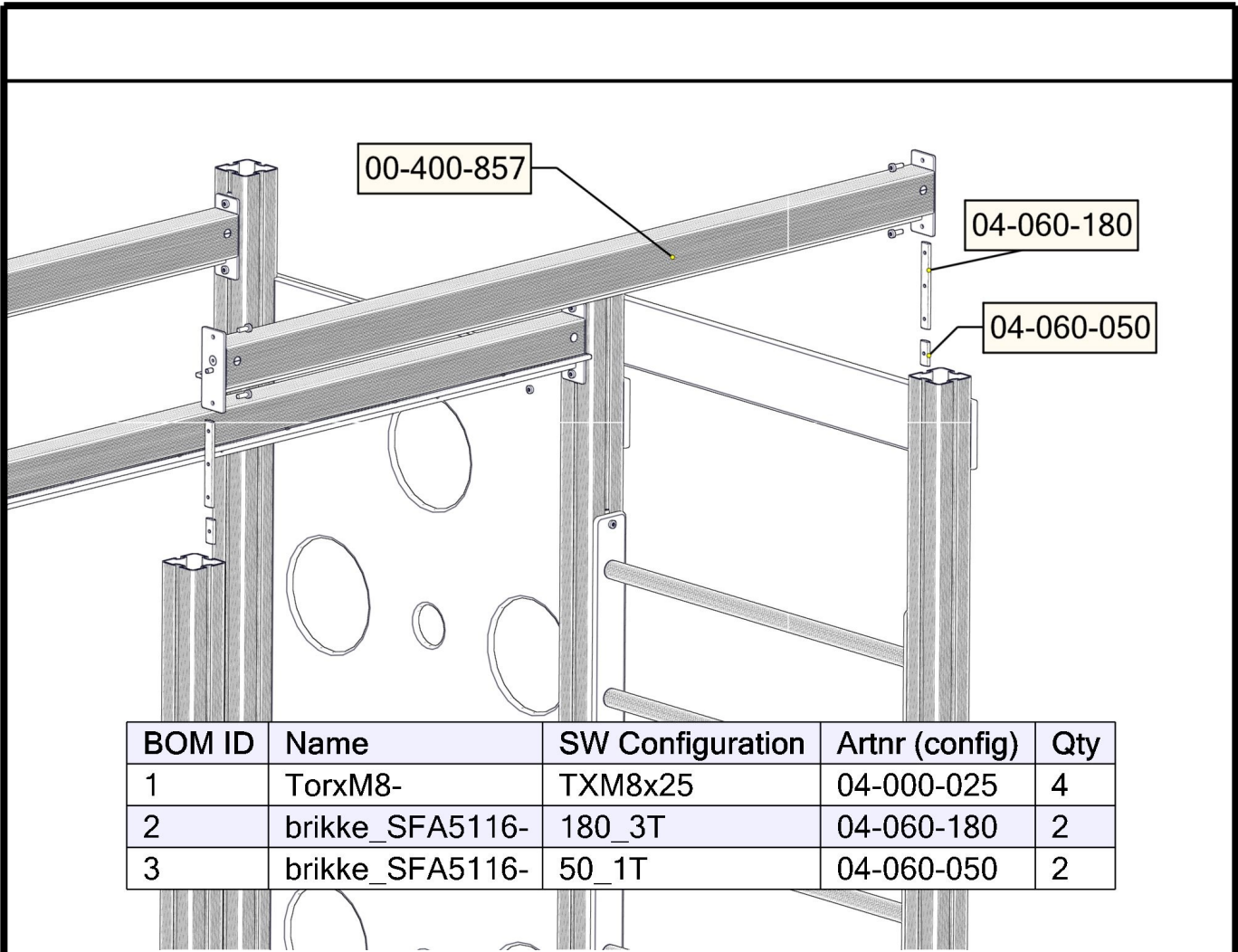

| BOM ID | Name | SW Configuration | Arnr (config) | Qty |
|--------|-----------------|------------------|---------------|-----|
| 1 | TorxM8- | TXM8x25 | 04-000-025 | 4 |
| 2 | brikke_SFA5116- | 180_3T | 04-060-180 | 2 |
| 3 | brikke_SFA5116- | 50_1T | 04-060-050 | 2 |

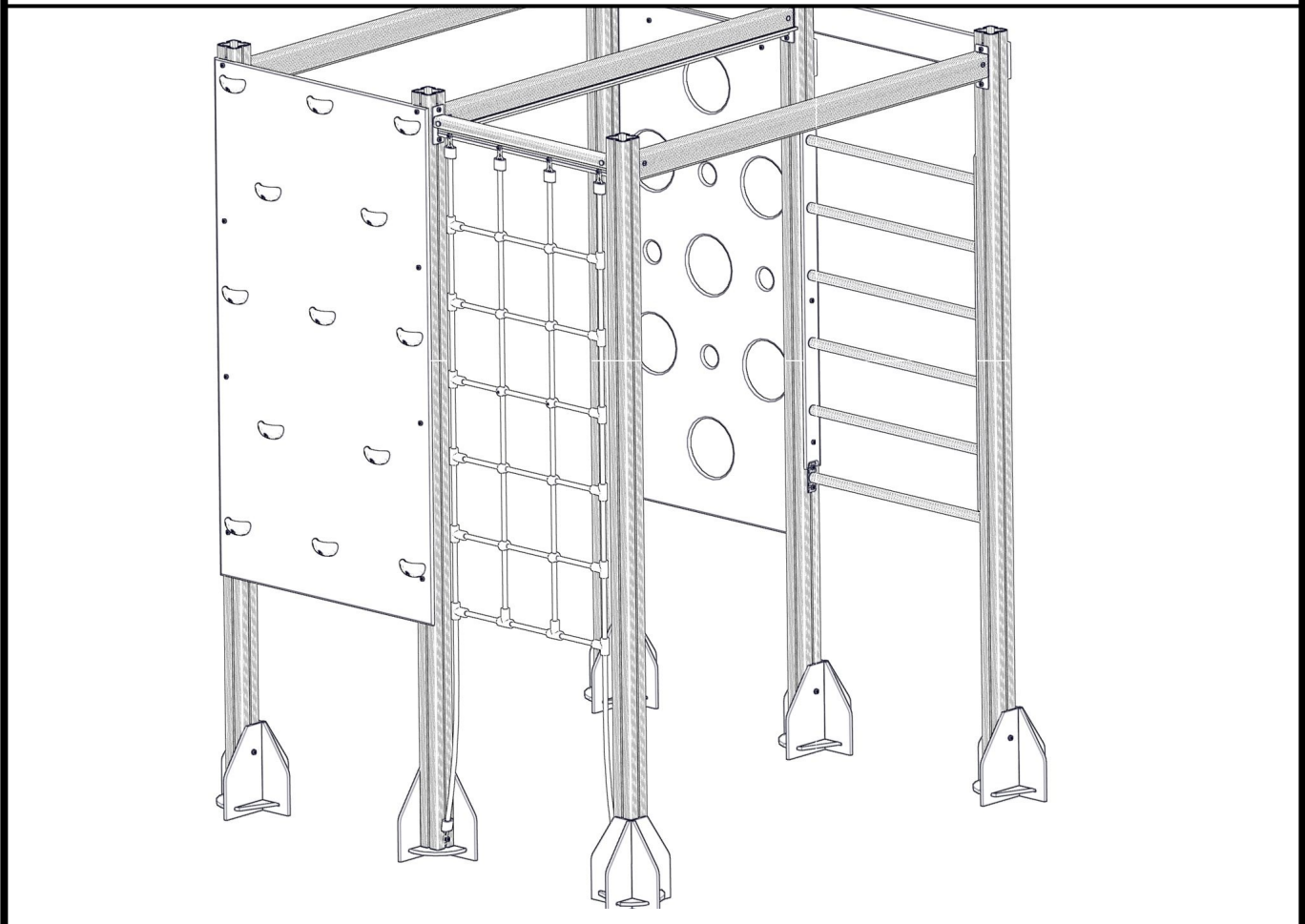

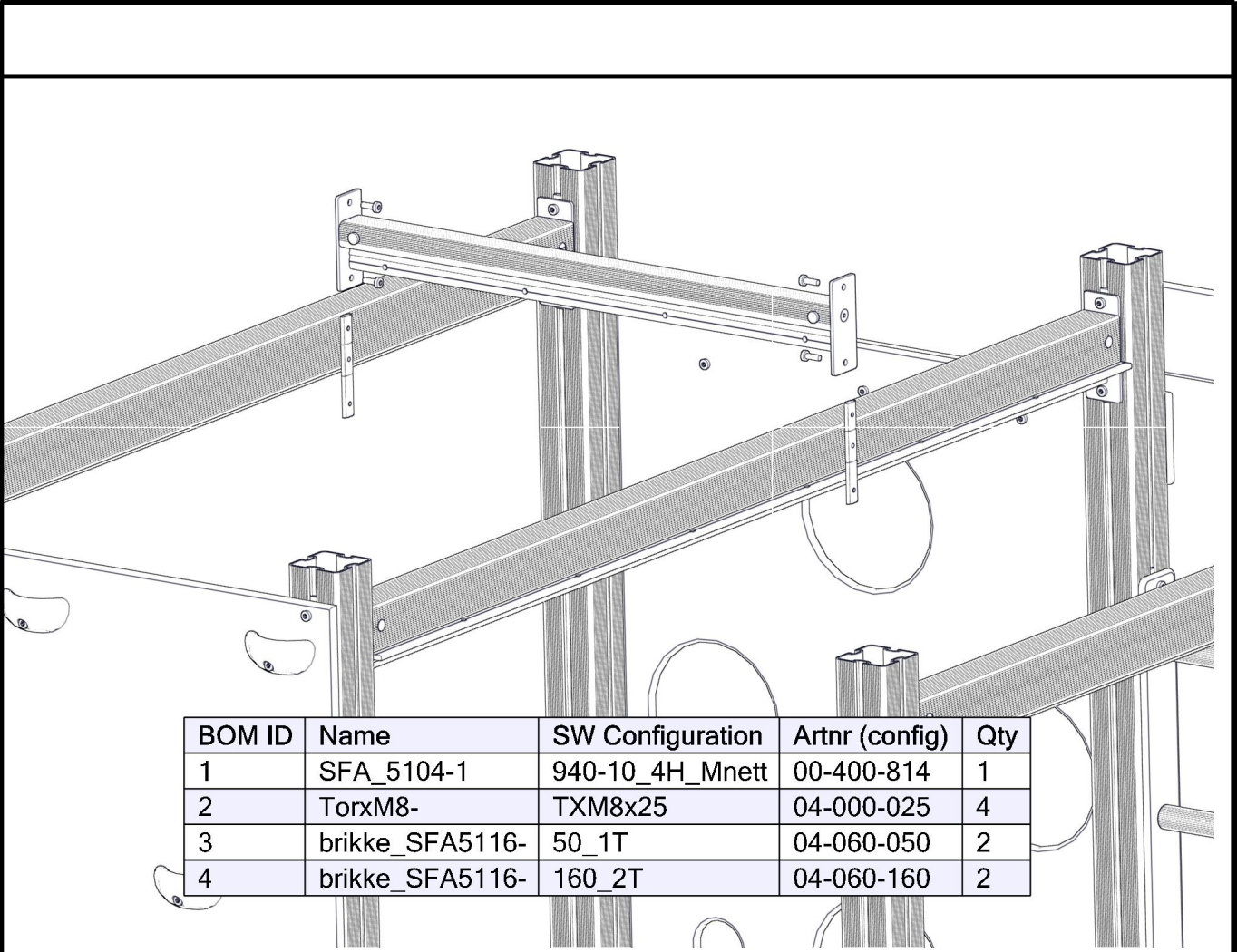

| BOM ID | Name | SW Configuration | Artnr (config) | Qty |
|--------|-----------------|------------------|----------------|-----|
| 1 | SFA_5104-1 | 940-10_4H_Mnett | 00-400-814 | 1 |
| 2 | TorxM8- | TXM8x25 | 04-000-025 | 4 |
| 3 | brikke_SFA5116- | 50_1T | 04-060-050 | 2 |
| 4 | brikke_SFA5116- | 160_2T | 04-060-160 | 2 |

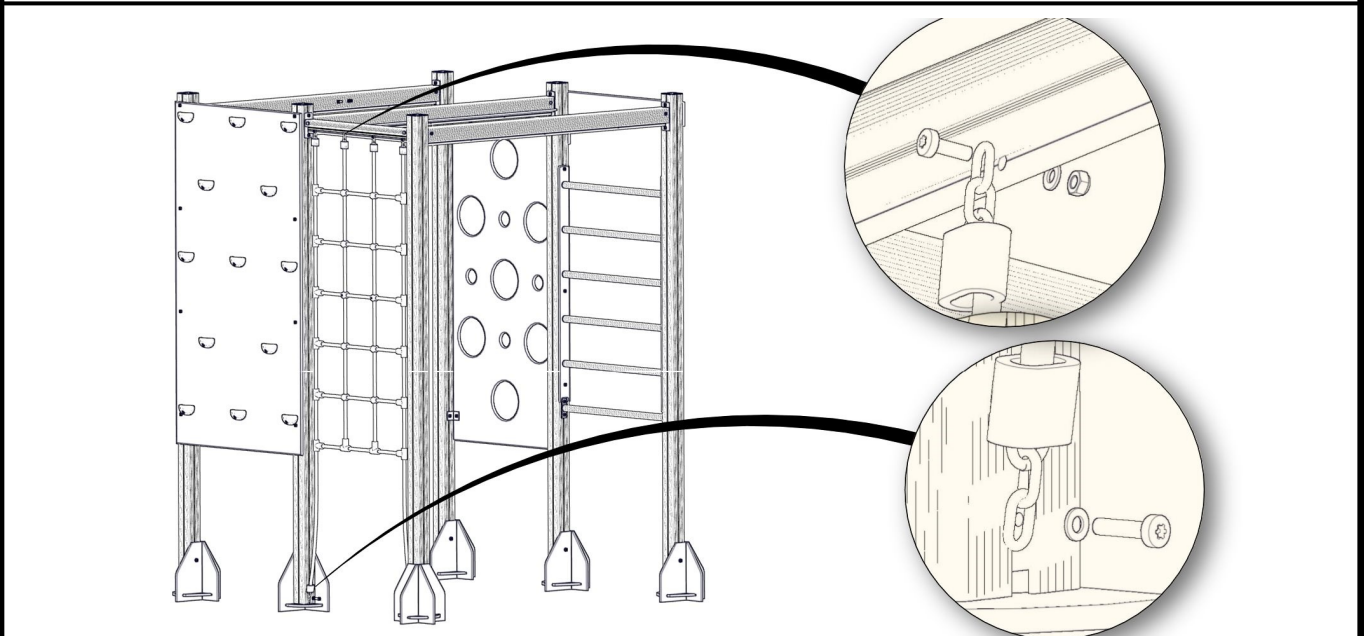

| BOM ID | Name | SW Configuration | Artnr (config) | Qty |
|--------|------------|------------------|----------------|-----|
| 1 | TorxM8- | TXM8x25 | 04-000-025 | 4 |
| 2 | TorxM8- | TXM8x35 | 04-000-035 | 2 |
| 3 | mutter_M8- | M8_Borg | 04-040-008 | 4 |
| 4 | Skive- | M8 | 04-050-008 | 6 |

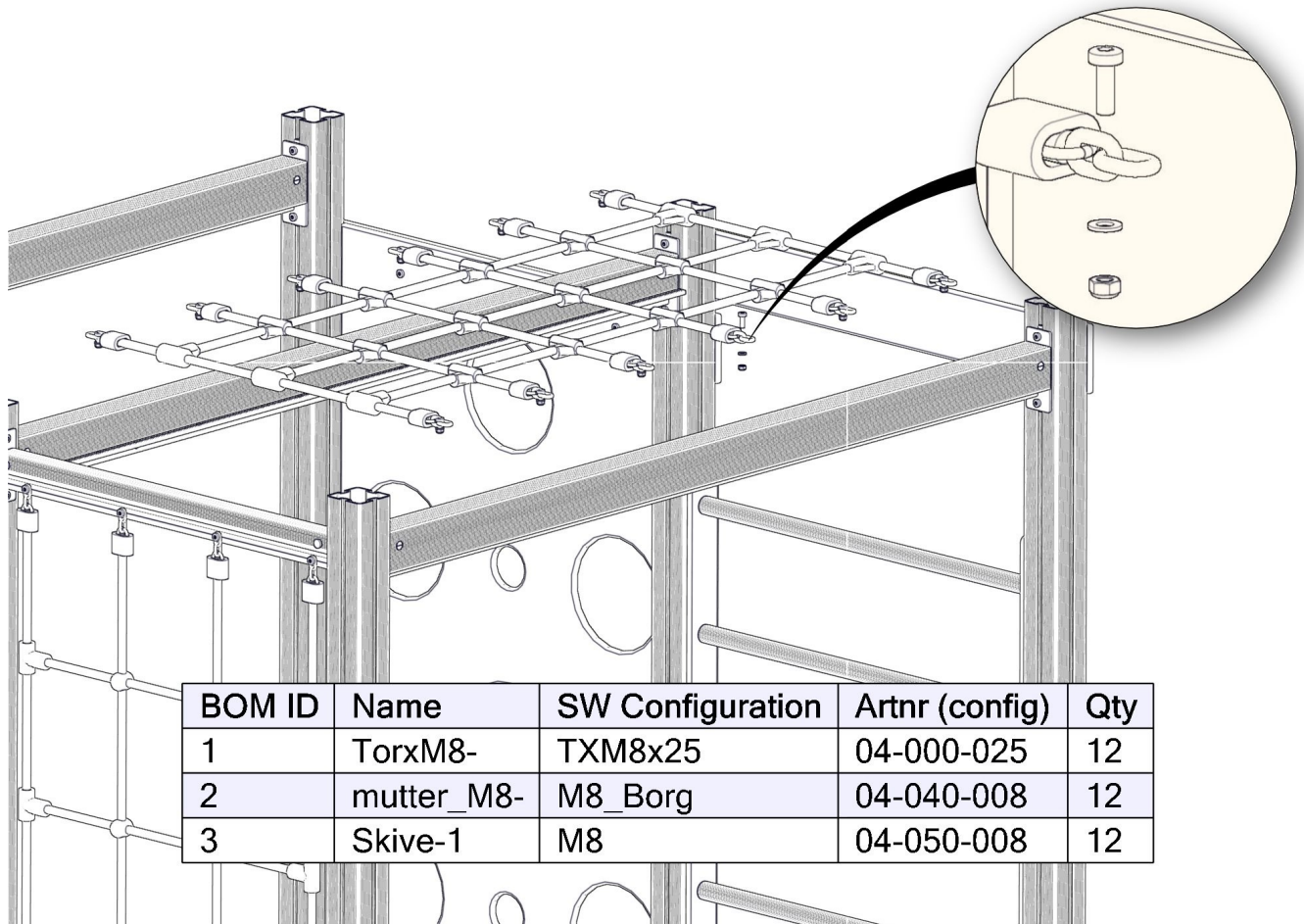
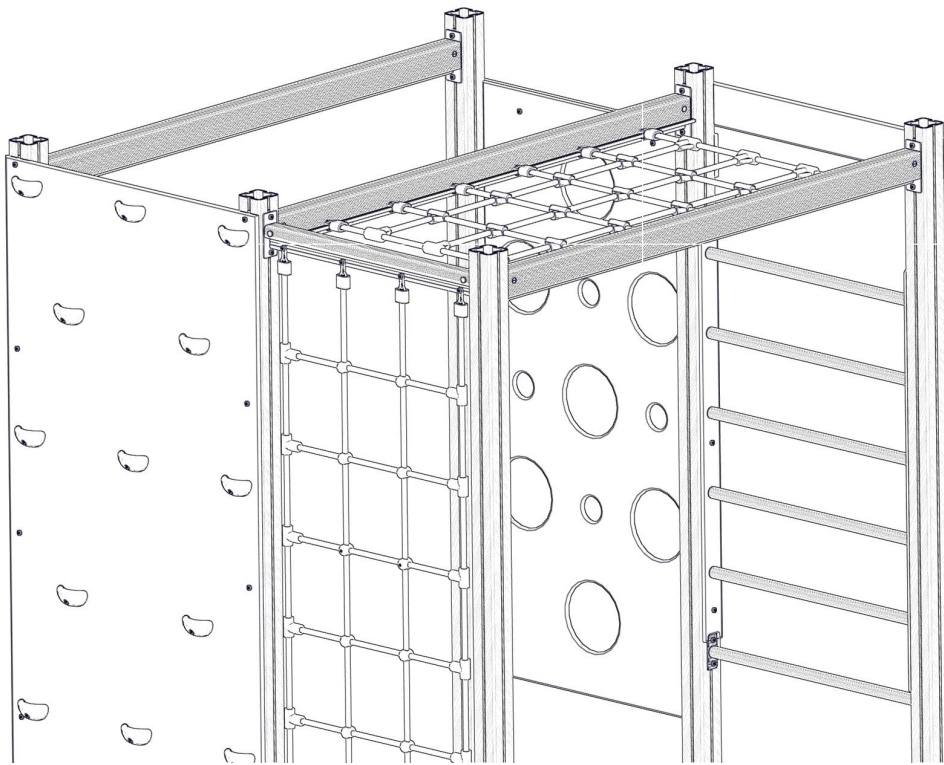

| BOM ID | Name | SW Configuration | Artnr (config) | Qty |
|--------|------------|------------------|----------------|-----|
| 1 | TorxM8- | TXM8x25 | 04-000-025 | 12 |
| 2 | mutter_M8- | M8_Borg | 04-040-008 | 12 |
| 3 | Skive-1 | M8 | 04-050-008 | 12 |

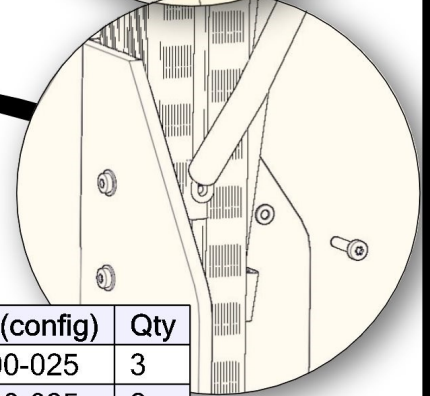
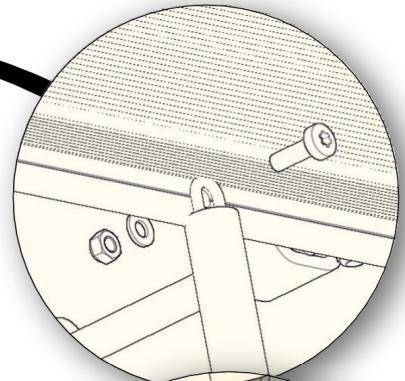
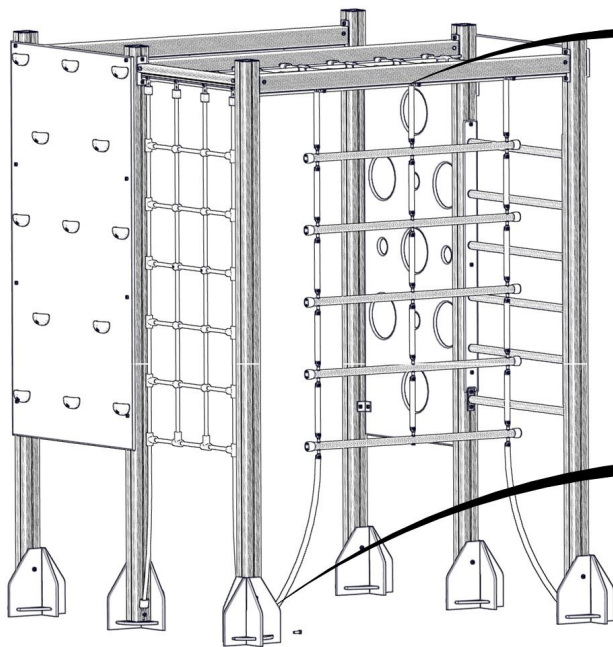
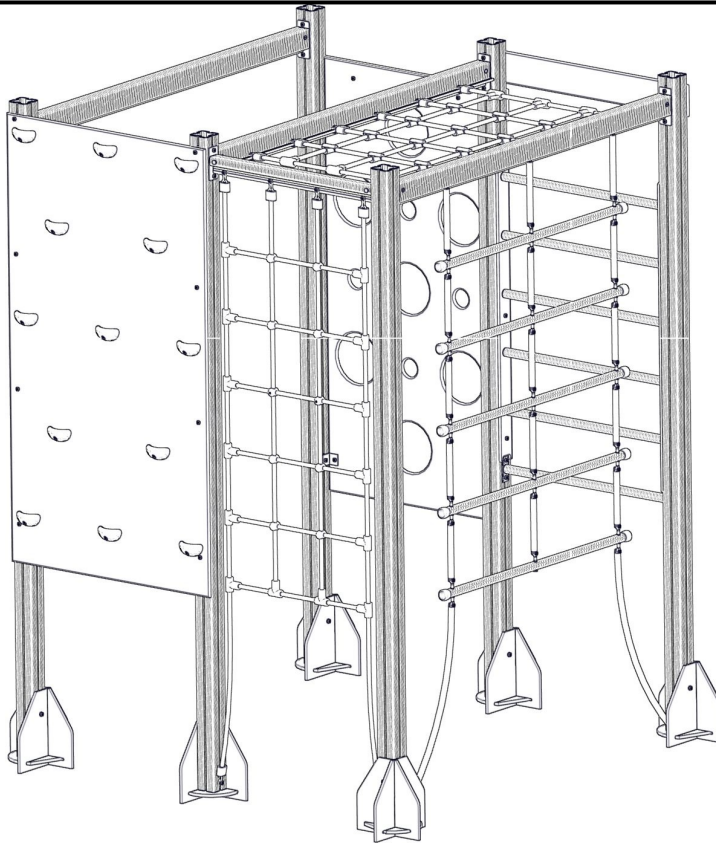

| BOM ID | Name | SW Configuration | Artnr (config) | Qty |
|--------|-------------|------------------|----------------|-----|
| 1 | Torxm8-6 | TXM8x25 | 04-000-025 | 3 |
| 2 | Torxm8- | TXM8x35 | 04-000-035 | 2 |
| 3 | mutter_M8-6 | M8_Borg | 04-040-008 | 3 |
| 4 | Skive- | M8 | 04-050-008 | 5 |

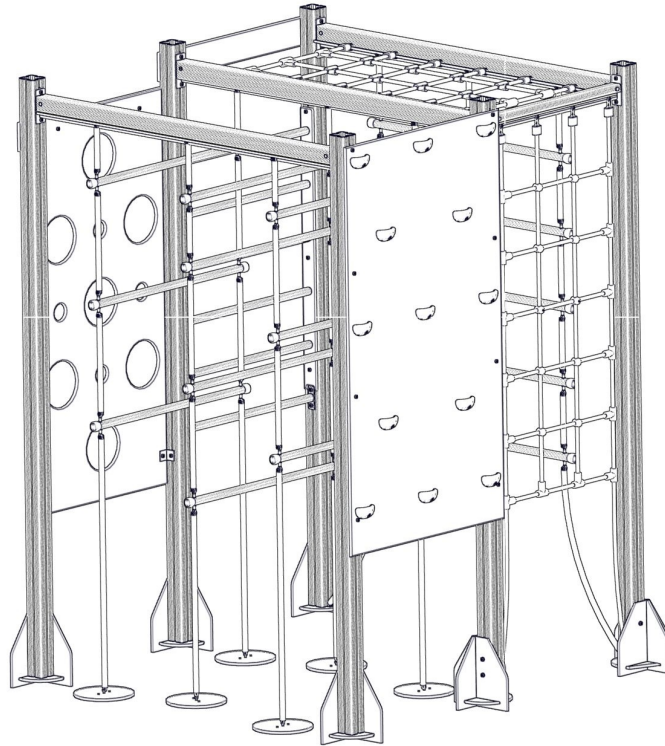

6x

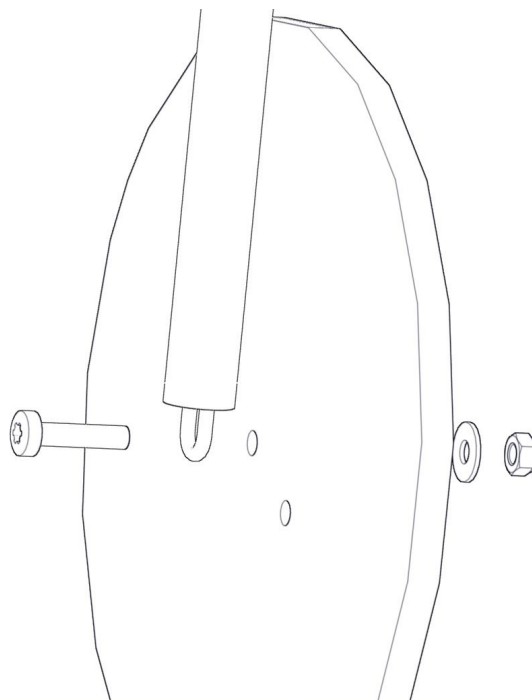

| BOM ID | Name | SW Configuration | Artnr (config) | Qty |
|--------|-----------------------|------------------|----------------|-----|
| 1 | Fundament_platte_2H-2 | Hoh80 | 00-003-106 | 1 |
| 2 | TorxM8-85 | TXM8x35 | 04-000-035 | 1 |
| 3 | mutter_M8-82 | M8_Borg | 04-040-008 | 1 |
| 4 | Skive-228 | M8_stor | 04-055-008 | 1 |

6x

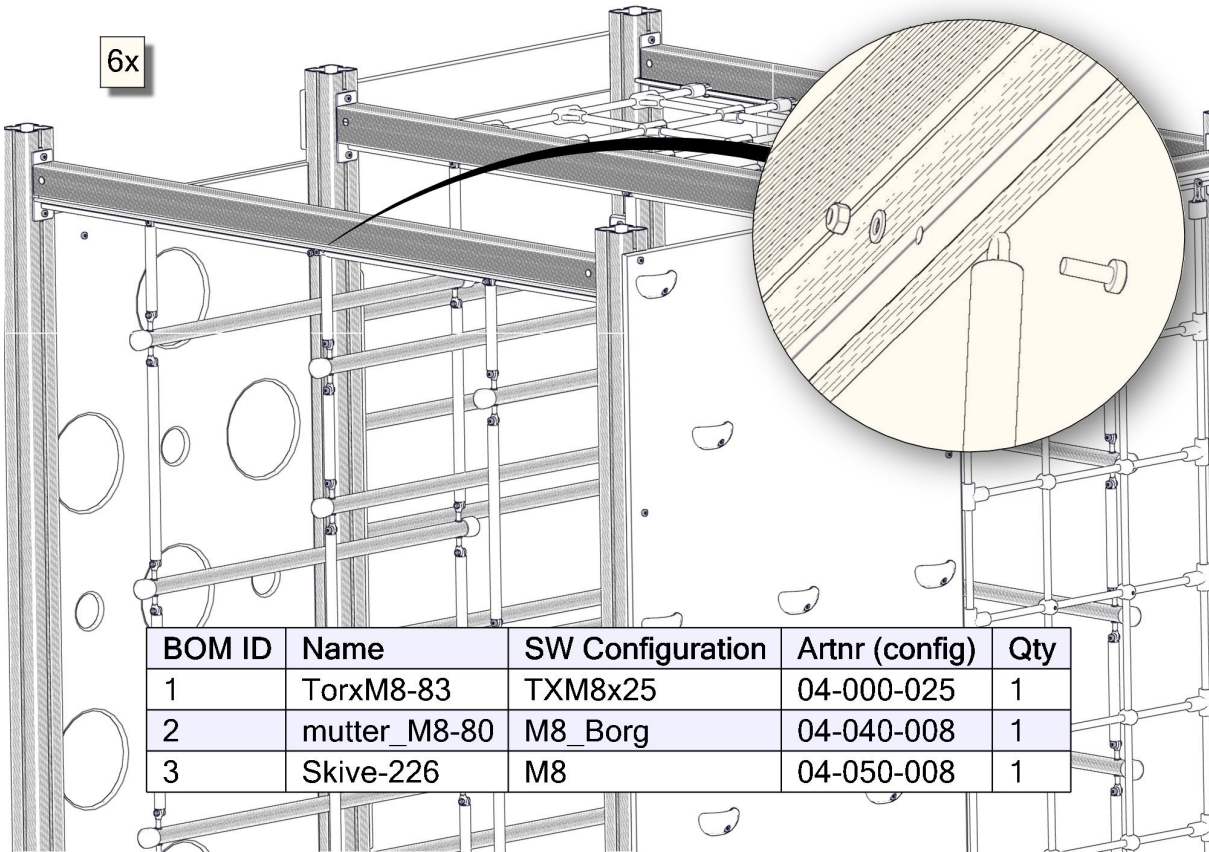

| BOM ID | Name | SW Configuration | Artnr (config) | Qty |
|--------|--------------|------------------|----------------|-----|
| 1 | TorxM8-83 | TXM8x25 | 04-000-025 | 1 |
| 2 | mutter_M8-80 | M8_Borg | 04-040-008 | 1 |
| 3 | Skive-226 | M8 | 04-050-008 | 1 |

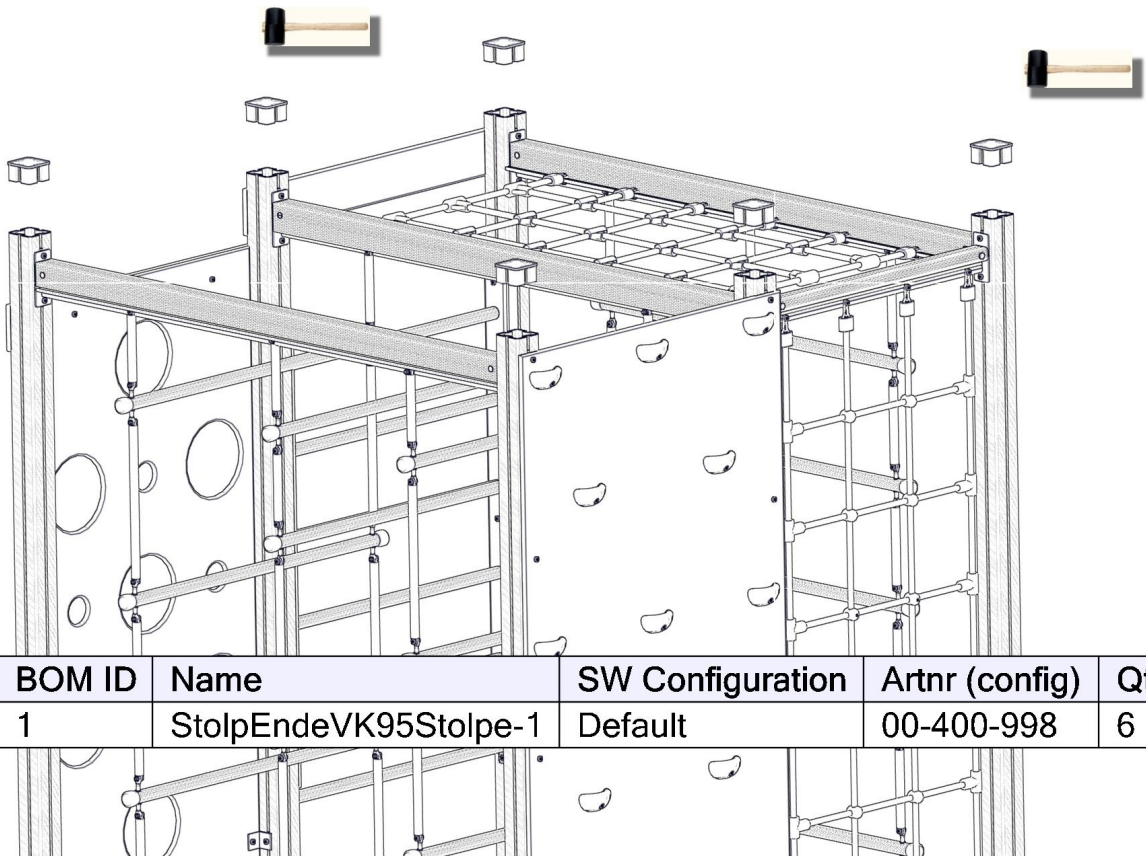









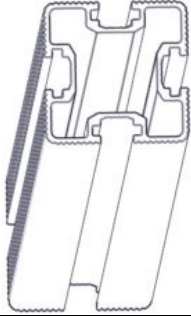
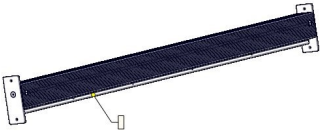
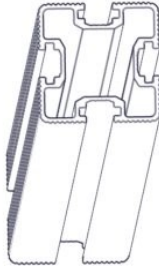
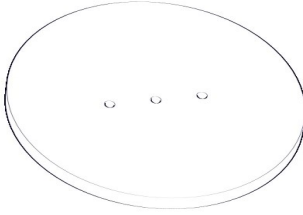
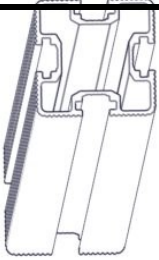

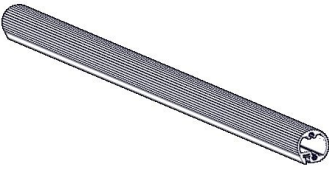
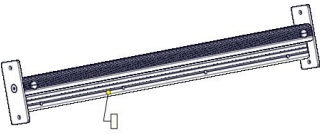

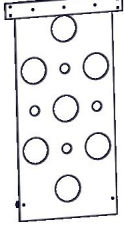



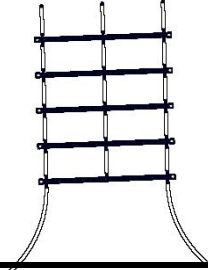

| BOM ID | Name | SW Configuration | Artnr (config) | Qty |
|--------|-----------------------|------------------|----------------|-----|
| 1 | StolpEndeVK95Stolpe-1 | Default | 00-400-998 | 6 |

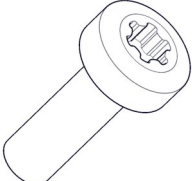
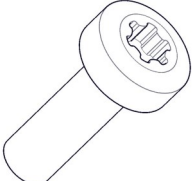
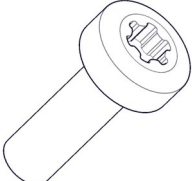
| Før utstyret tas i bruk / Before play begins / Innan lekredskapet tas i bruk | |
|---|--|
| N | <ul style="list-style-type: none"> ● Påse at fallunderlag er utlagt i henhold til gjeldende regler eller vår anbefaling ● Fjern alle monteringshjelpemidler (rester av betong, planker, paller, plast, og lignende) ● Før utstyret tas i bruk, burde man sjekke at det ikke er fare for at anorakksnorer og lignende som kan hekte seg fast noen steder på lekeapparatet. (Vedlagte snor med dobbe (kneledd) kan brukes til å sjekke at dette er i orden. Se vedlagte veiledning for bruk av denne. Dette gjøres for å oppdage eventuelle feilmonteringer.?) ● NB! Bør stå i 2-3 dager før bruk |
| EN | <ul style="list-style-type: none"> ● Make sure the area and depth of safer surfacing are according to the current standard, or to the manufacturer's recommendation ● Make sure all tools and surplus materials are removed before play begins ● PS! When complete, allow 2-3 days for the concrete to set before use |
| S | <ul style="list-style-type: none"> ● Kontrollera att fallunderlag är utlagt enligt gällande regler eller vårt rekommendation ● Ta bort alla monteringshjälpmedel (rester av betong, plankor, pallar, plast och liknande) ● Innan lekredskapet används, kontrollera att anoracksnoddar eller kläder/delar av kläder eller liknande inte kan fastna i några delar på redskapet. (Den bipackade "knävringen" kan man med fördel användas för denna kontroll. ● Detta görs för att upptäcka eventuella felmonteringar.) |

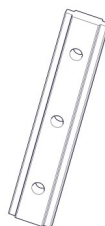
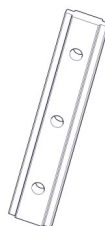
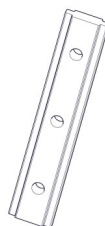
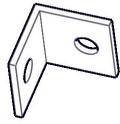
Boltpakker for / Boltpackage for / Bultpaket för

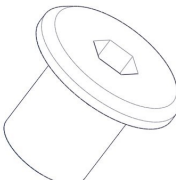
Sign. _____

| | | |
|---|---|---|
|  | <p>VK 95 3030 4 00-400-038</p> |  <p>Drager L=1980 1 3hull vertikal 00-400-858</p> |
|  | <p>Stolpe med HPL høyre 1 00-400-016</p> |  <p>Fundamentplate 6 00-003-106</p> |
|  | <p>Stolpe med HPL Venstre 1 00-400-017</p> |  <p>Drager L=1980 2 6hull horizontal 3 hull vertikal 00-400-857</p>  <p>Produktmerking 0 Hos Søve</p> |
|  | <p>Sperrerør 940 5 00-400-149</p> |  <p>Drager L=940 1 4hull vertikal 00-400-815</p> |
|  | <p>Sperrerør med beslag 1 00-400-150</p> |  <p>Klatrevegg 1 00-400-750</p> |
|  | <p>Sprosse 1 00-400-102</p> |  <p>Klatrevegg 1 00-400-720</p> |

| komponenter | | Sign. _____ |
|--|------------------------------------|-------------|
|  | M-nett 05-079-014 | 1 |
|  | Tak-Nett 05-100-006 | 1 |
|  | Æ-Nett 05-103-018 | 1 |
|  | ÅÅ-nett 05-103-017 | 2 |
|  | Å-nett 05-103-108 | 1 |
|  | Torx M8x12 04-000-012 | 2 |
|  | Torx M8x25 04-000-025 | 47 |
|  | Torx M8x35 04-000-035 | 26 |
|  | Brikke 50-1T 04-060-050 | 14 |
|  | Brikke 120-3T 04-060-120 | 2 |
|  | Brikke 150-3T 04-060-150 | 4 |
|  | Brikke 160 2T 04-060-160 | 2 |
|  | Vinkel 50x50x50x5 04-070-036 | 2 |
|  | Brikke 180-3T 04-060-180 | 6 |
|  | Møbelknapp 04-030-016 | 2 |
|  | Ende lokk 00-400-998 | 6 |
|  | Låsemutter M8 04-040-008 | 31 |
|  | Skive M8 04-050-008 | 31 |
|  | Eventuelt Fundamenter | 6 |
| | Torx M8x35 04-000-035 | 18 |
| | Brikke 50_1T 04-060-050 | 6 |
| | Brikke 120_3T 04-060-120 | 6 |

MTK : 31-03-2020
Endring sikkerhetszone areal