

N**Monteringsanvisning****EN****Assembly Instructions****S****Monteringsanvisning**

Produkt nr. / Product no. / Produkt nr.

40-142-090**Rød**

Ord. nr. _____

Dato. _____







Sign. _____

**søve**

Søve AS
Grønnvoldveien 290
3830 Ulefoss - Norway
Tlf: +47 35 94 65 65
www.sove.no

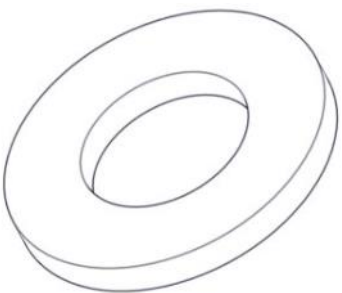
**søve**

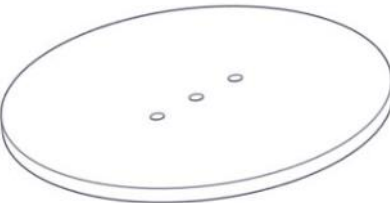
Søve AB
EA Rosengrensgatan 32
421 31 Västra Frölunda
Phone: +46 (0)31 773 97 00
www.sove.se

Boltepakker for / Boltpackage for / Bultpaket för		Sign. _____		
Rutsjebane H=1,2m rød 40-142-090	Navn	Artnr/dimensjon	Ant	Lev
	Rutsjebane system Gulvhøyde = 1,2m Bredde = 0,5m rød	03-200-090	1	
	Torx M8x35 Torx M8x45	04-000-035 04-000-050	4 2	
	Skive M8	04-050-008	10	
	Låsemutter M8	04-040-008	6	
	Fundamentplate Rund	00-003-103	2	
	Stålforankring Lengde = 600mm	00-100-316	2	

Montering av lekeapparatet / Assembly instructions / Montering av lekredskapet

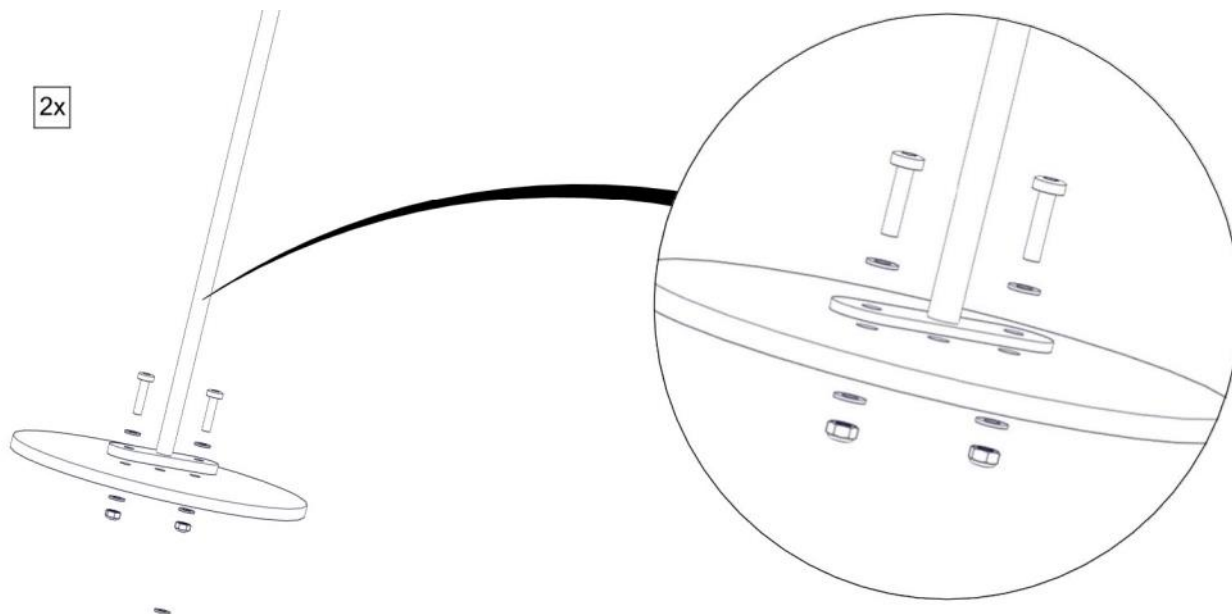





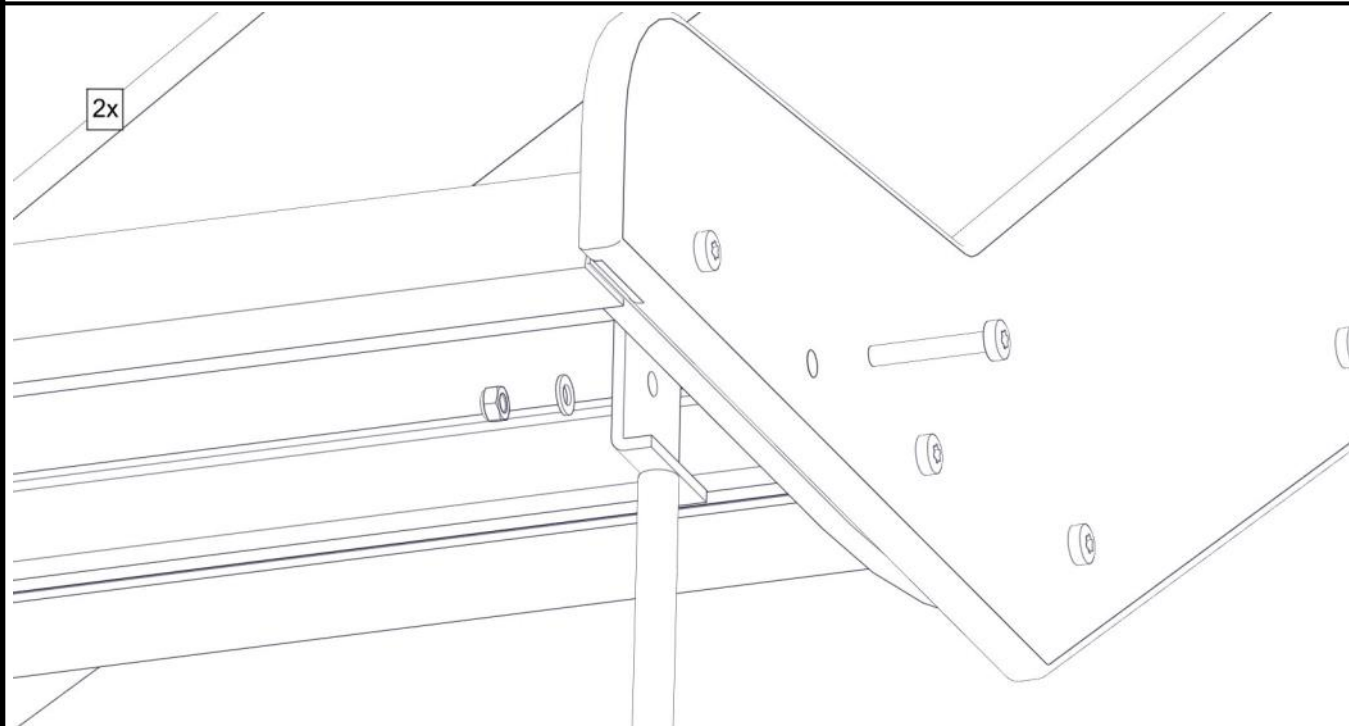

Part Name	Article nr.	Qty
Torx M8x35	04-000-035	2
Stålforankring L=600	00-100-316	1
Skive M8	04-050-008	4

Part Name	Article nr.	Qty
Låsemutter M8	04-040-008	2
Fundament plate	00-003-103	1

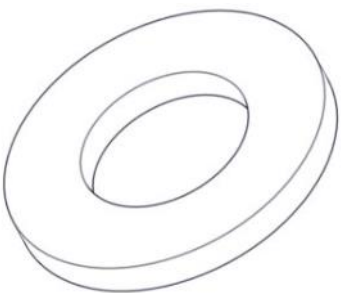

Part Name	Article nr.	Qty
Torx M8x35	04-000-035	1
Skive M8	04-050-008	1

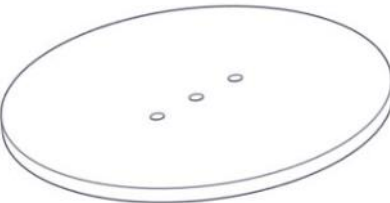
Part Name	Article nr.	Qty
Låsemutter M8	04-040-008	1

Boltepakker for / Boltpackage for / Bultpaket för		Sign. _____		
Rutsjebane H=1,2m rød 40-142-090	Navn	Artnr/dimensjon	Ant	Lev
	Rutsjebane system Gulvhøyde = 1,2m Bredde = 0,5m rød	03-200-090	1	
	Torx M8x35 Torx M8x45	04-000-035 04-000-050	4 2	
	Skive M8	04-050-008	10	
	Låsemutter M8	04-040-008	6	
	Fundamentplate Rund	00-003-103	2	
	Stålforankring Lengde = 600mm	00-100-316	2	