

N

**Monteringsanvisning**

EN

**Assembly Instructions**

S

**Monteringsanvisning**

Produkt nr. / Product no. / Produkt nr.

**40-142-099K****Grønn**

Ord. nr. \_\_\_\_\_

Dato. \_\_\_\_\_







Sign. \_\_\_\_\_

**søve**

Søve AS  
Grønnvoldveien 290  
3830 Ulefoss - Norway  
Tlf: +47 35 94 65 65  
[www.sove.no](http://www.sove.no)

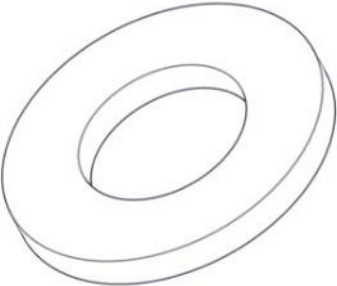

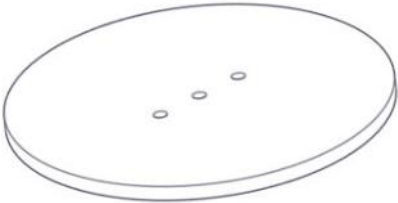
**søve**

Søve AB  
EA Rosengrensgatan 32  
421 31 Västra Frölunda  
Phone: +46 (0)31 773 97 00  
[www.sove.se](http://www.sove.se)

| <b>Boltepakker for / Boltpackage for / Bultpaket för</b>                            |   | Sign. _____                            |              |            |
|---|---|--|--------------|------------|
| <b>Rutsjebane m/portal grønn<br/>40-142-099K</b>                                    | <b>Navn</b>   | <b>Artnr/dimensjon</b>                 | <b>Ant</b>   | <b>Lev</b> |
|    | Rutsjebane system<br>Gulvhøyde = 1,4m<br>Bredde = 0,5m<br>Grønn | 40-142-099                             | 1            |            |
|    | Torx M8x25<br>Torx M8x35<br>Torx M8x50                          | 04-000-025<br>04-000-035<br>04-000-050 | 16<br>8<br>2 |            |
|   | Skive M8  | 04-050-008                             | 10           |            |
|  | Låsemutter M8   | 04-040-008                             | 6            |            |
|  | Fundamentplate<br>Rund  | 00-003-103                             | 2            |            |
|  | Stålforankring<br>Lengde = 600mm                                | 00-100-316                             | 2            |            |

**Boltepakker for / Boltpackage for / Bultpaket för**

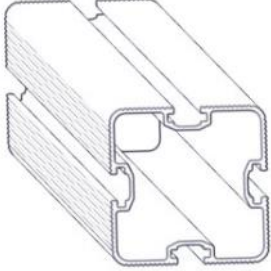
Sign. \_\_\_\_\_

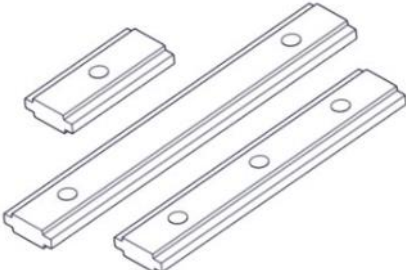
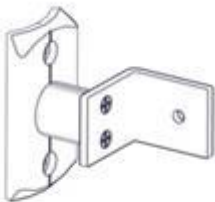
| Rutsjebane m/portal grønn<br>40-142-110K  | Navn   | Artnr/dimensjon                        | Ant         | Lev |
|---|--|--|-------------|-----|
|    | Stolpe 70x70 portal<br>Lengde = 850<br>GRÅ           | SFA5123/2                              | 2           |     |
|    | Endelokk til<br>70x70 stolpe                         | 00-400-996                             | 2           |     |
|  | Sperrerør L=520<br>Sort                              | 07-510-160                             | 1           |     |
|  | Brikke 160 3xM8<br>Brikke 50 1xM8<br>Brikke 120 3xM8 | 04-060-160<br>04-060-050<br>04-060-120 | 2<br>4<br>6 |     |
|  | Feste portal cc880<br>VK70<br>Sort                   | 01-400-231                             | 4           |     |
|   |  |  |             |     |

## Montering av lekeapparatet / Assembly instructions / Montering av lekredskapet



| Part Name            | Article nr. | Qty |
|----------------------|-------------|-----|
| Torx M8x50           | 04-000-050  | 2   |
| Torx M8x35           | 04-000-035  | 4   |
| Stålforankring L=600 | 00-100-316  | 2   |
| Skive M8             | 04-050-008  | 10  |

| Part Name                      | Article nr. | Qty |
|--------------------------------|-------------|-----|
| Rutsjebanel H=1420 cc880 B=520 | 40-142-099  | 1   |
| Låsemutter M8                  | 04-040-008  | 6   |
| Fundament plate                | 00-003-103  | 2   |

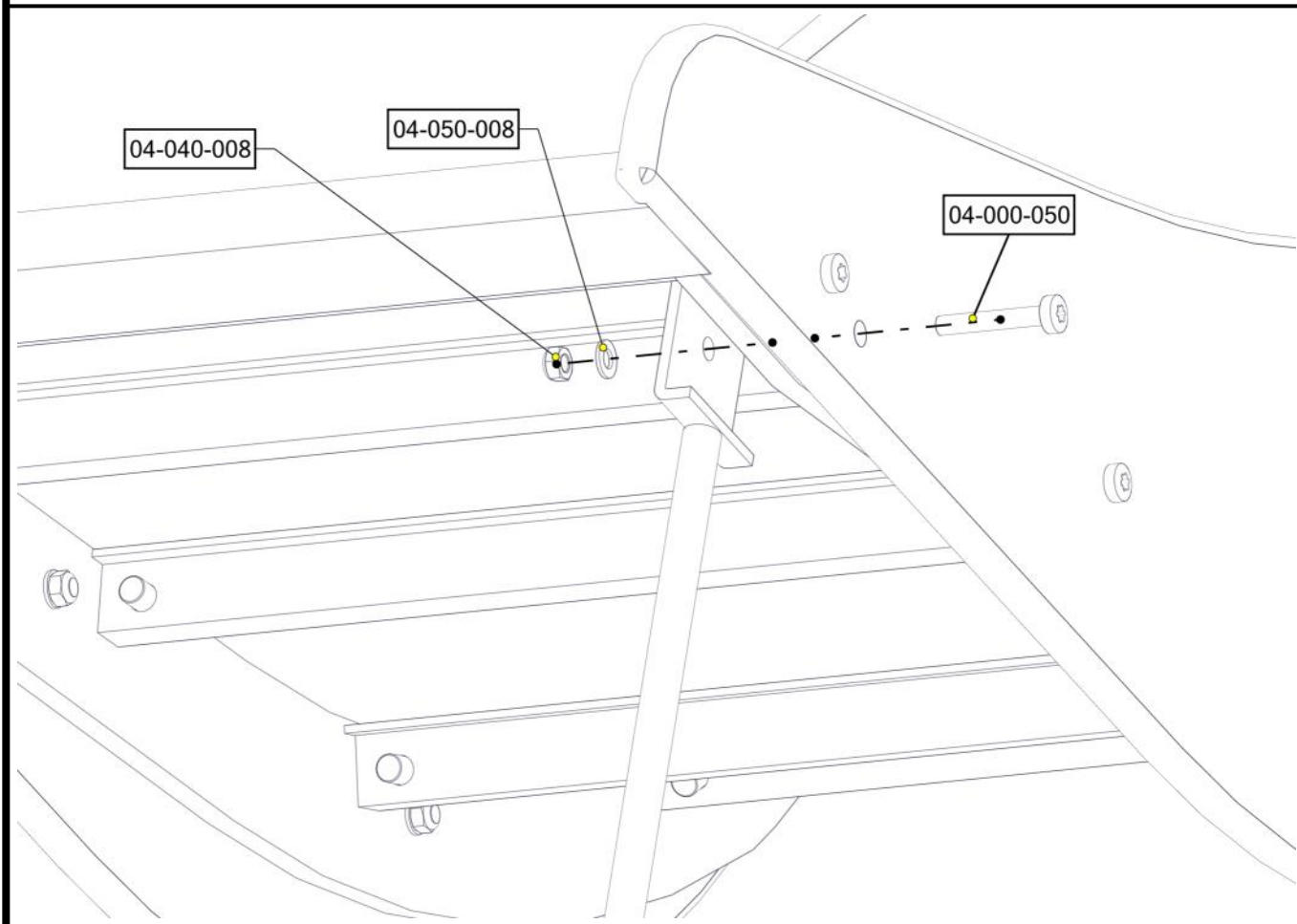

## Montering av lekeapparatet / Assembly instructions / Montering av lekredskapet

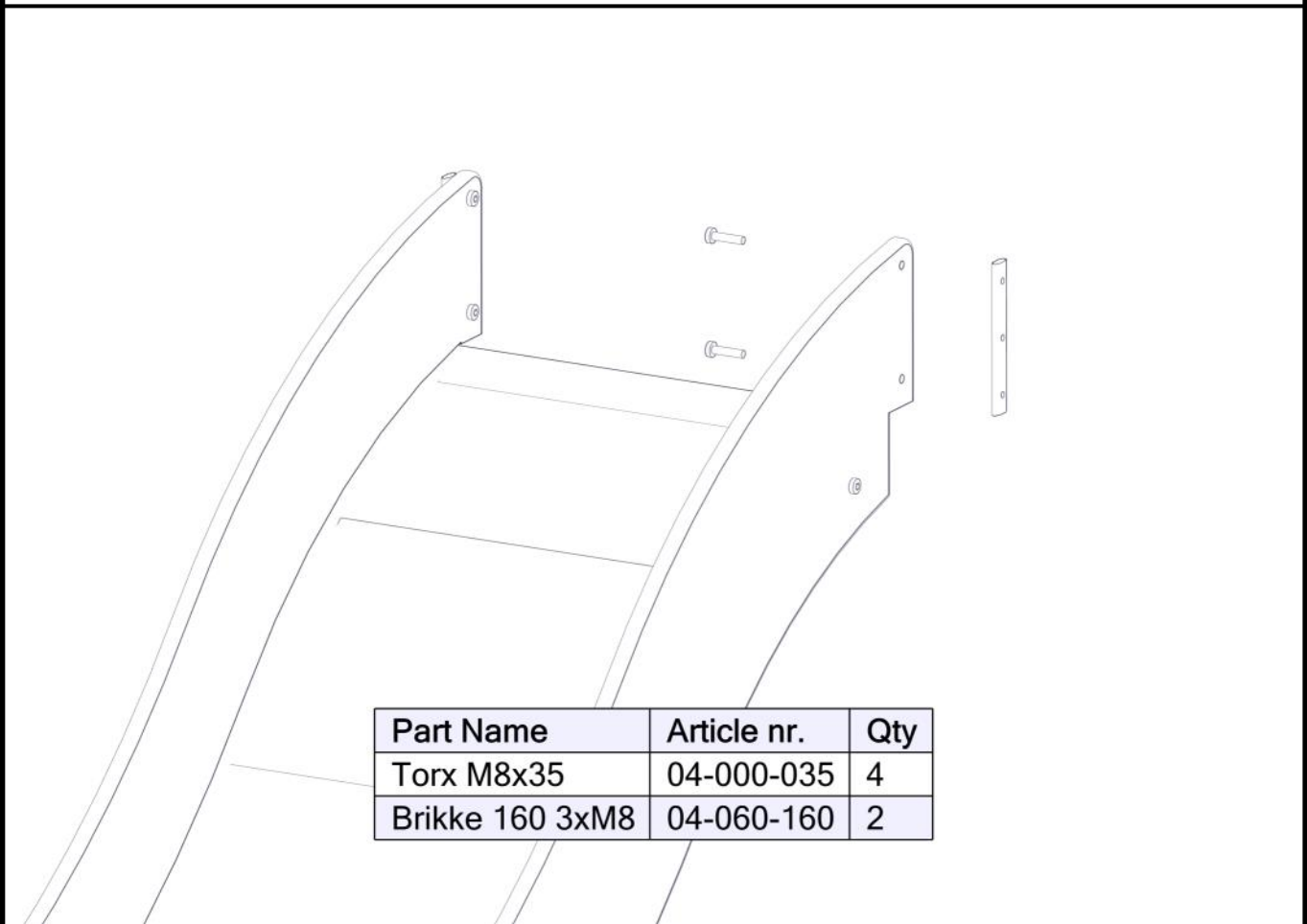
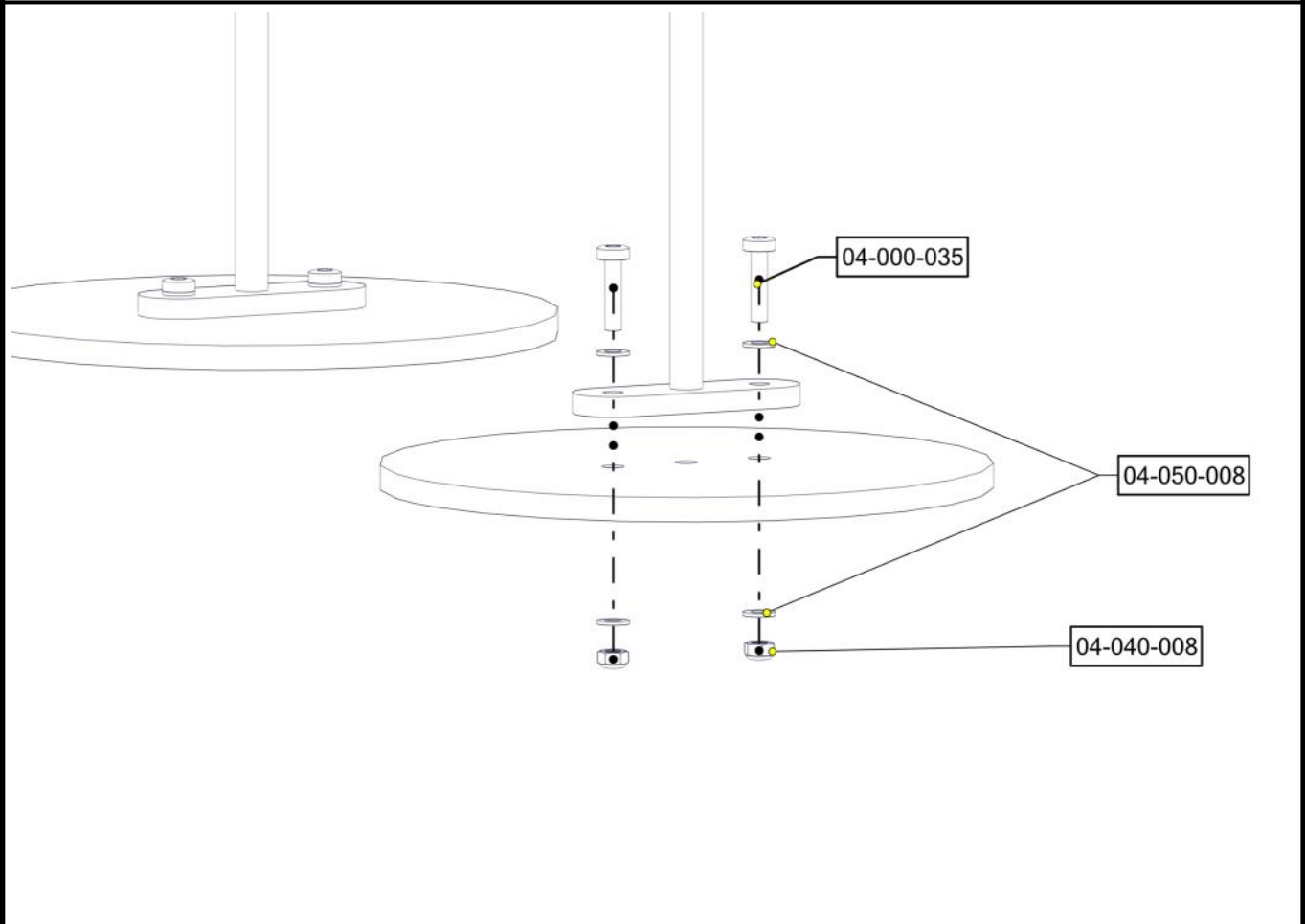

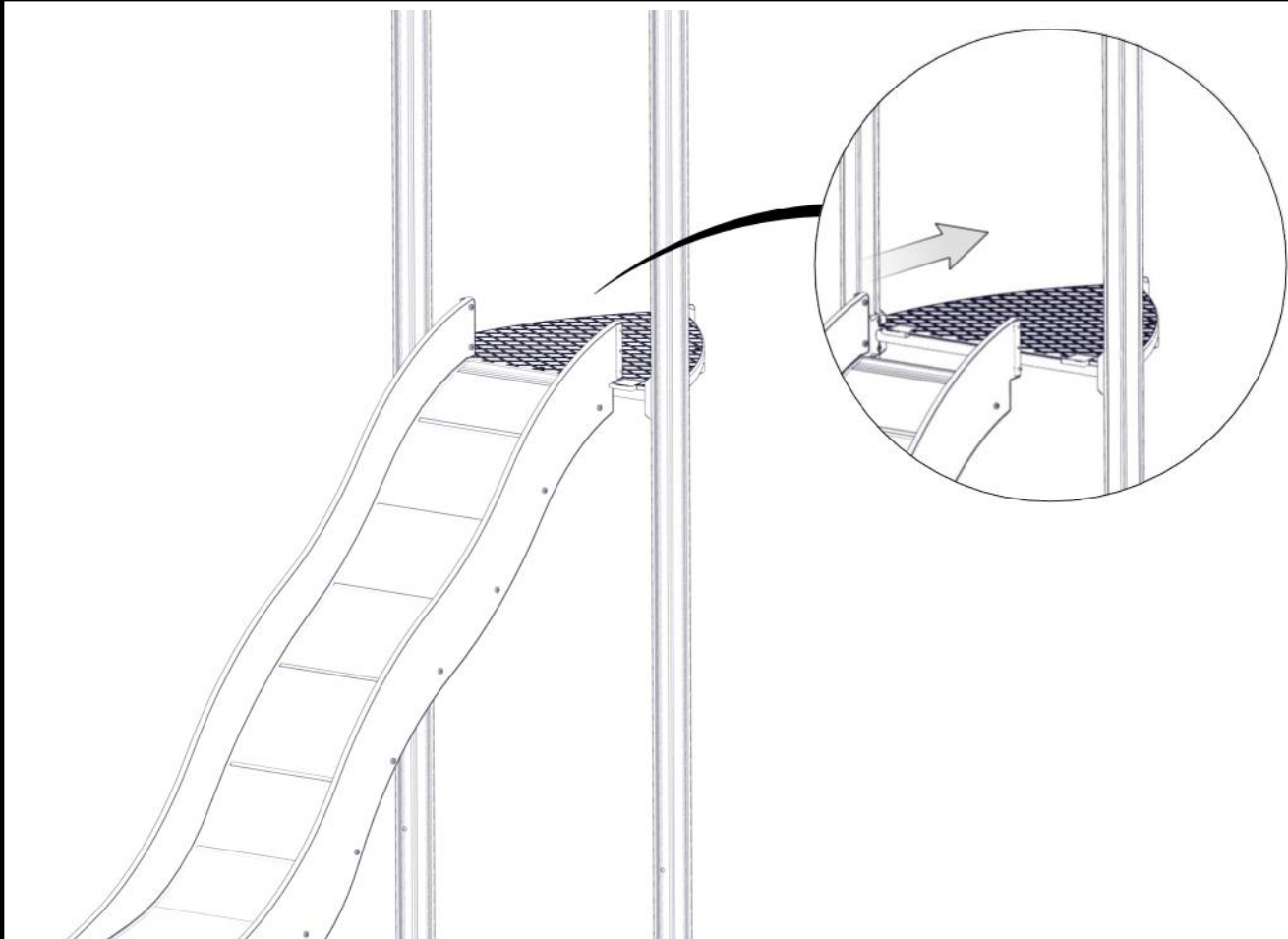
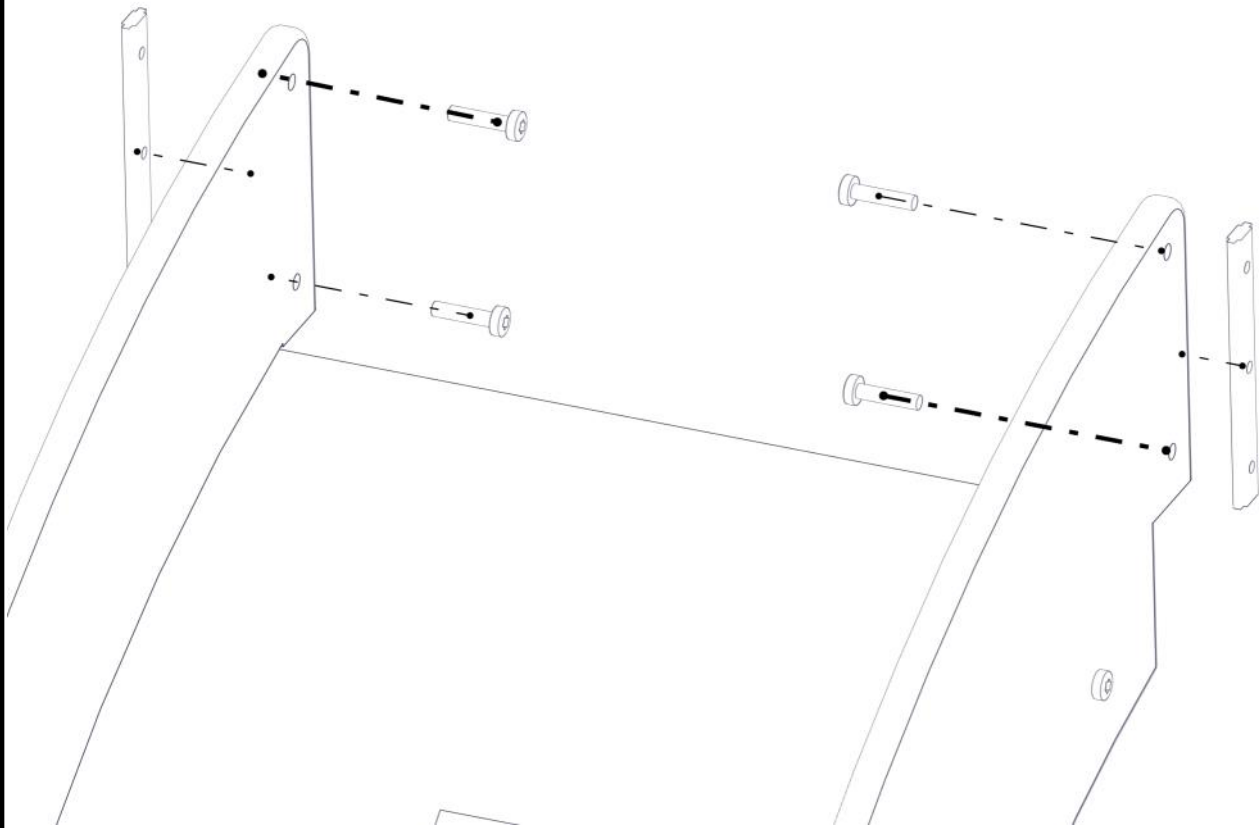
**Montering av lekeapparatet / Assembly instructions / Montering av lekredskapet**

## Montering av lekeapparatet / Assembly instructions / Montering av lekredskapet

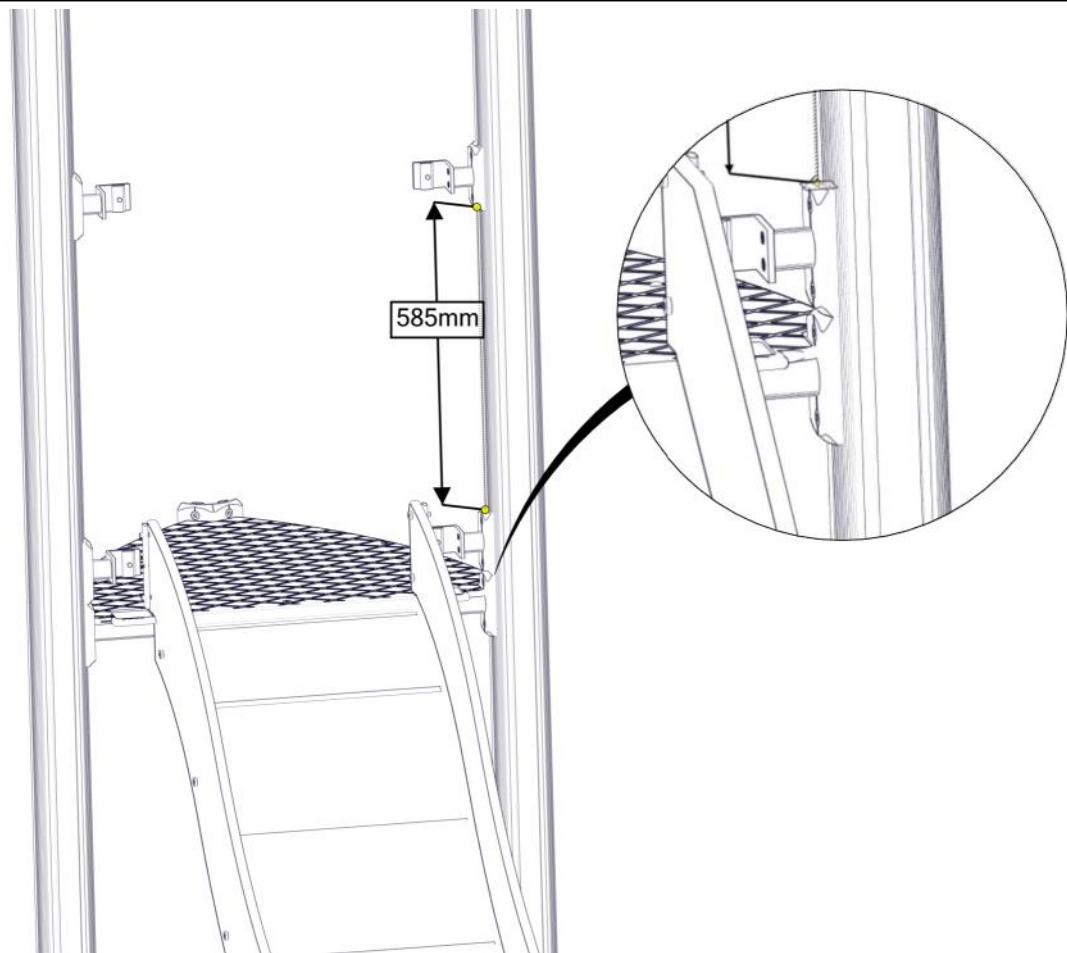

4x

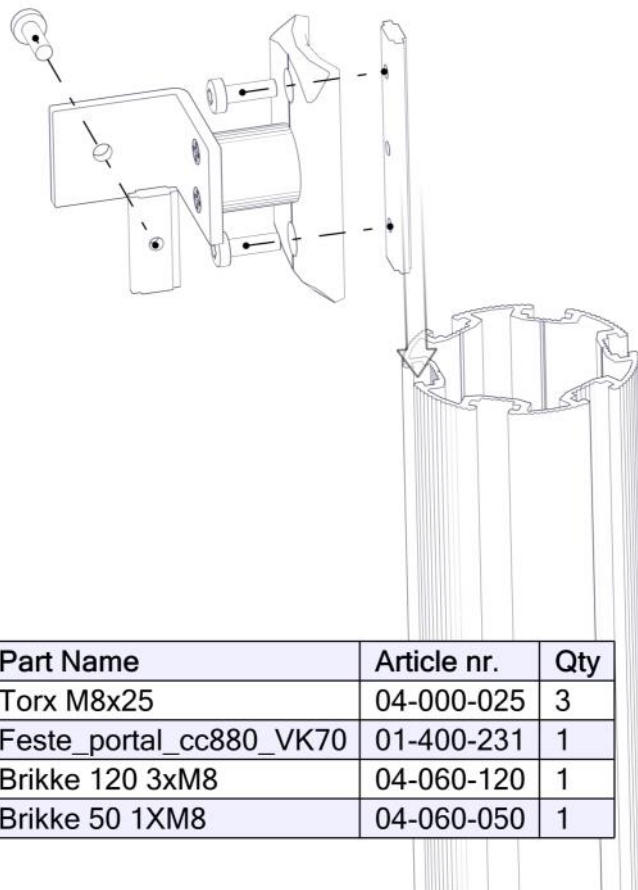

| Part Name               | Article nr. | Qty |
|-------------------------|-------------|-----|
| Torx M8x25              | 04-000-025  | 3   |
| Feste_portal_cc880_VK70 | 01-400-231  | 1   |
| Brikke 120 3xM8         | 04-060-120  | 1   |
| Brikke 50 1XM8          | 04-060-050  | 1   |



## Montering av lekeapparatet / Assembly instructions / Montering av lekredskapet

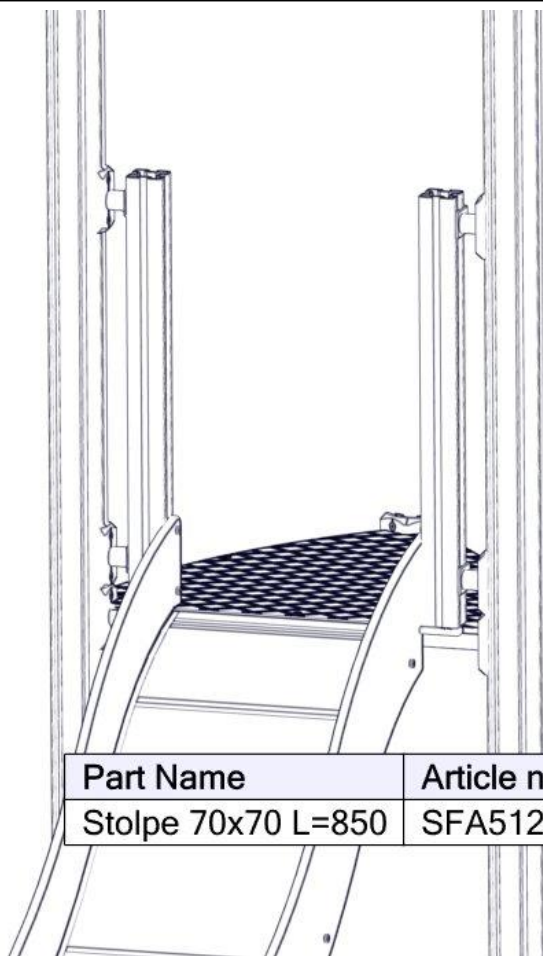

| Part Name          | Article nr. | Qty |
|--------------------|-------------|-----|
| Stolpe 70x70 L=850 | SFA5123/2   | 2   |

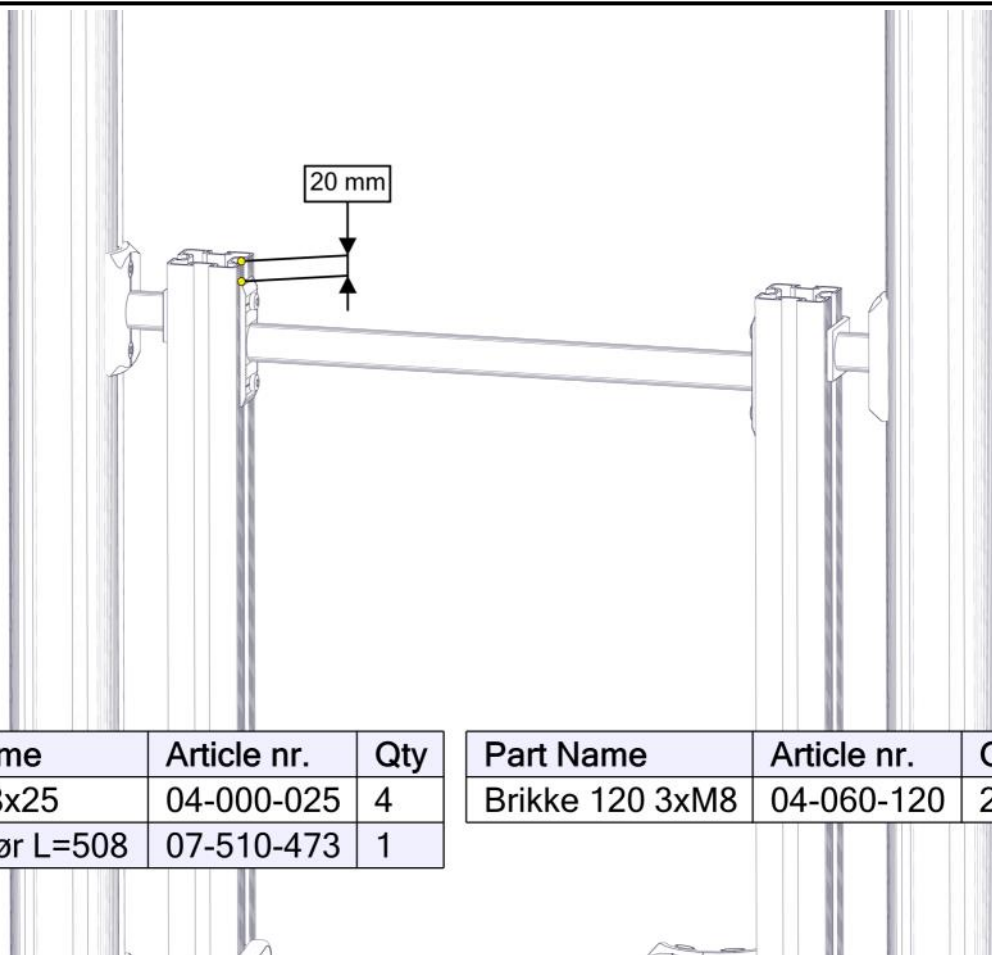

| Part Name       | Article nr. | Qty |
|-----------------|-------------|-----|
| Torx M8x25      | 04-000-025  | 4   |
| Sperrerør L=508 | 07-510-473  | 1   |





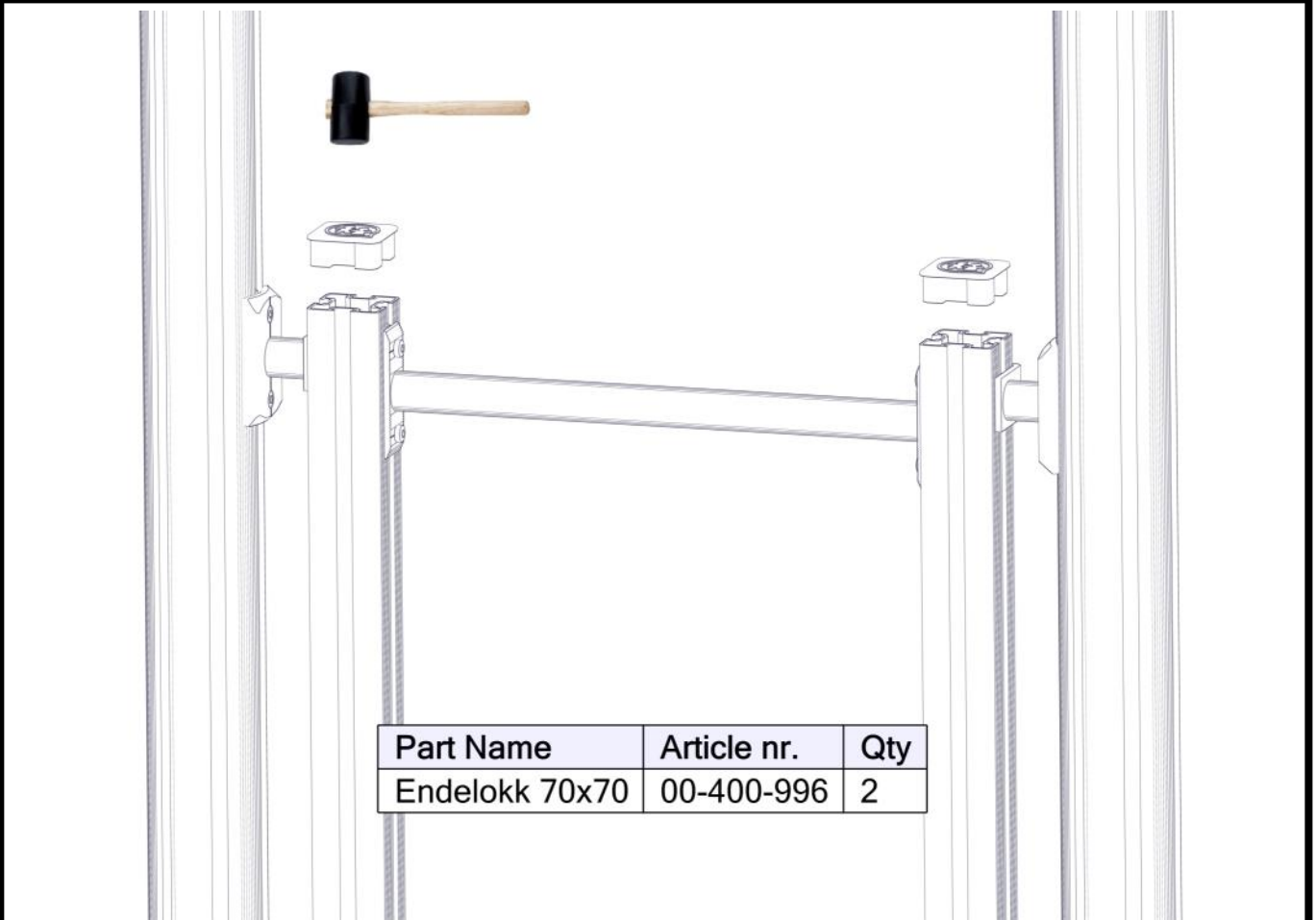
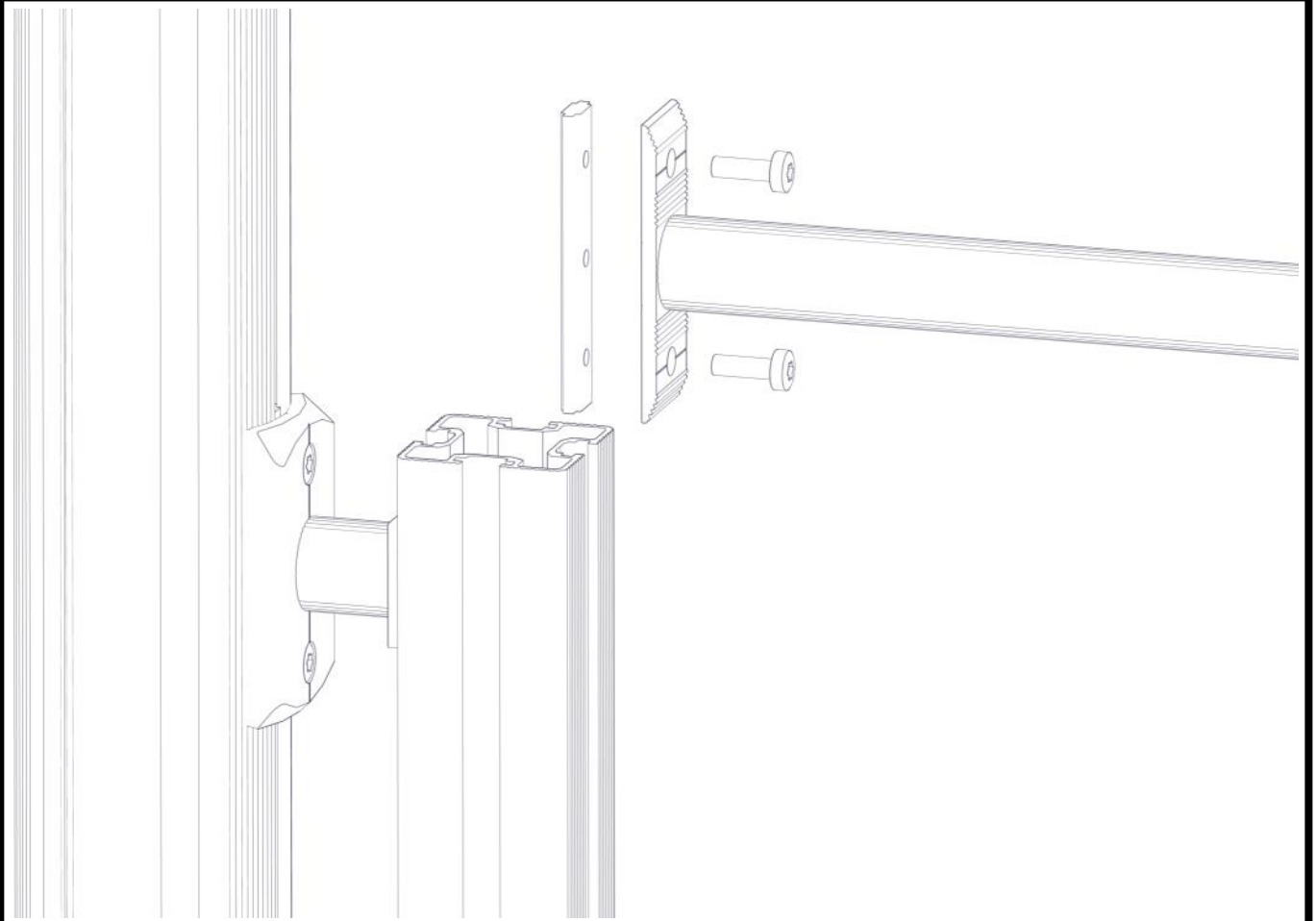

| Part Name       | Article nr. | Qty |
|-----------------|-------------|-----|
| Brikke 120 3xM8 | 04-060-120  | 2   |



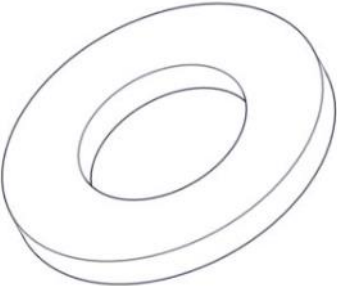

**Montering av lekeapparatet / Assembly instructions / Montering av lekredskapet**

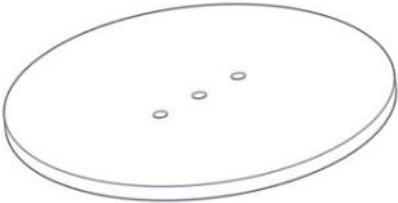
| Part Name      | Article nr. | Qty |
|----------------|-------------|-----|
| Endelokk 70x70 | 00-400-996  | 2   |

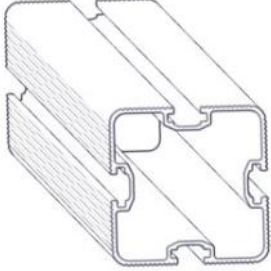

| <b>Boltepakker for / Boltpackage for / Bultpaket för</b>                            |   | Sign. _____                            |              |            |
|---|---|--|--------------|------------|
| <b>Rutsjebane m/portal grønn<br/>40-142-099K</b>                                    | <b>Navn</b>   | <b>Artnr/dimensjon</b>                 | <b>Ant</b>   | <b>Lev</b> |
|    | Rutsjebane system<br>Gulvhøyde = 1,4m<br>Bredde = 0,5m<br>Grønn | 40-142-099                             | 1            |            |
|    | Torx M8x25<br>Torx M8x35<br>Torx M8x50                          | 04-000-025<br>04-000-035<br>04-000-050 | 16<br>8<br>2 |            |
|   | Skive M8  | 04-050-008                             | 10           |            |
|  | Låsemutter M8   | 04-040-008                             | 6            |            |
|  | Fundamentplate<br>Rund  | 00-003-103                             | 2            |            |
|  | Stålforankring<br>Lengde = 600mm                                | 00-100-316                             | 2            |            |

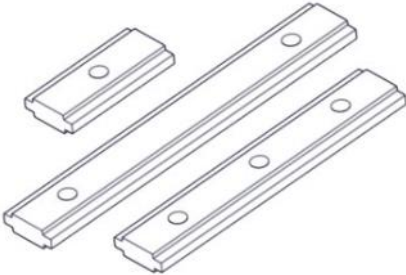
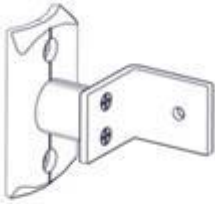
| <b>Boltepakker for / Boltpackage for / Bultpaket för</b>                            |  | Sign. _____                            |             |            |
|---|--|--|-------------|------------|
| <b>Rutsjebane m/portal grønn<br/>40-142-110K</b>                                    | <b>Navn</b>  | <b>Artnr/dimensjon</b>                 | <b>Ant</b>  | <b>Lev</b> |
|    | Stolpe 70x70 portal<br>Lengde = 850<br>GRÅ           | SFA5123/2                              | 2           |            |
|    | Endelokk til<br>70x70 stolpe                         | 00-400-996                             | 2           |            |
|  | Sperrerør L=520<br>Sort                              | 07-510-160                             | 1           |            |
|  | Brikke 160 3xM8<br>Brikke 50 1xM8<br>Brikke 120 3xM8 | 04-060-160<br>04-060-050<br>04-060-120 | 2<br>4<br>6 |            |
|  | Feste portal cc880<br>VK70<br>Sort                   | 01-400-231                             | 4           |            |
|   |  |  |             |            |

02.04.2023 MNO

Forandret lengde av stålforankring til 600 mm