

**N****Monteringsanvisning****EN****Assembly Instructions****S****Monteringsanvisning**

Produkt nr. / Product no. / Produkt nr.

**40-142-422****Rød**

Ord. nr. \_\_\_\_\_

Dato. \_\_\_\_\_

Sign. \_\_\_\_\_

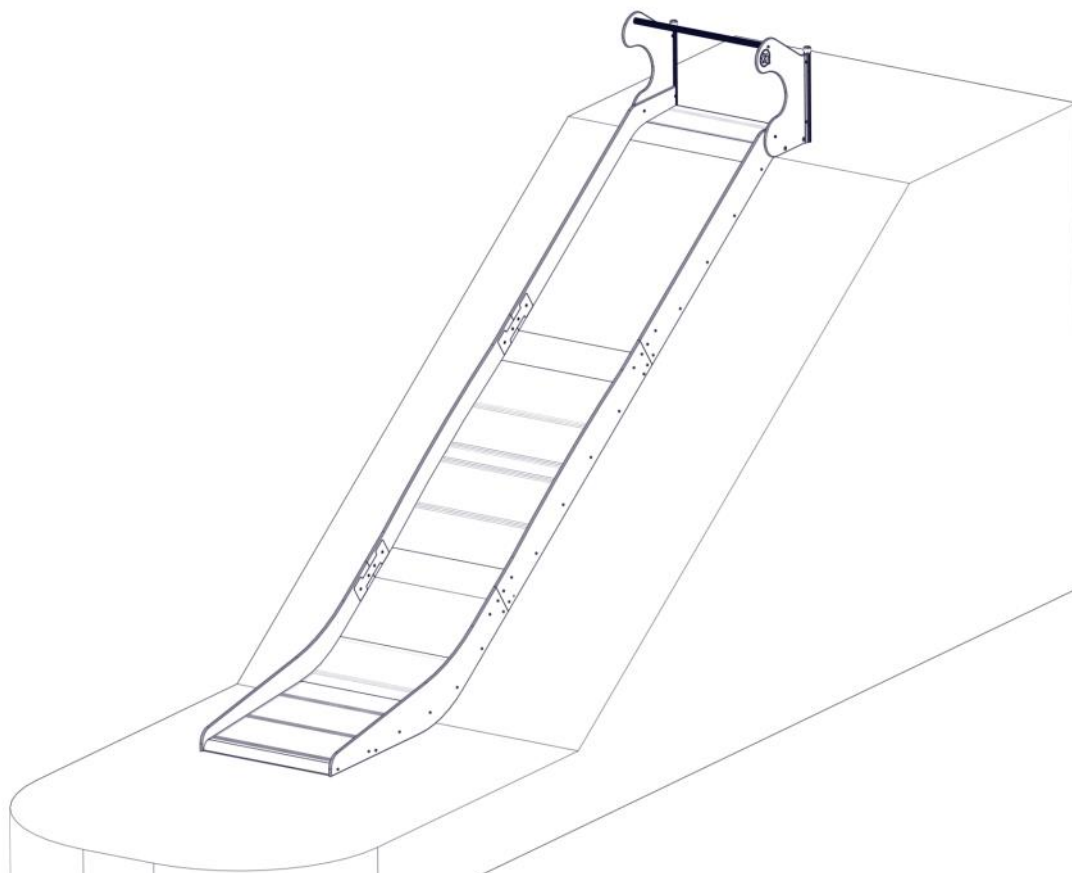
**sove**

Søve AS  
Grønnvoldveien 290  
3830 Ulefoss - Norway  
Tlf: +47 35 94 65 65  
[www.sove.no](http://www.sove.no)

**söve**

Søve AB  
EA Rosengrensgatan 32  
421 31 Västra Frölunda  
Phone: +46 (0)31 773 97 00  
[www.sove.se](http://www.sove.se)

## Monteringstips / Assembly Advice / Monteringsstips

**N**

- Les monteringsanvisningen nøye før montering.
- Monter elementene i rekkefølgen som vist.
- Boltene bør ikke skrues for hardt til før alt er montert, vatret og loddet. Skru så boltene til.
- NB! Ved bruk av drill, kan boltene ryke.
- På grunn av at solen kan gjøre rutsjeflaten veldig varm, bør rutsjebanens utløp vende mot nord-øst eller nord-vest.
- Er lekeutstyret plassert i naturlige ferdselstraséer må området sikres mot gjennomgang.
- Innspringningshinder bør vurderes rundt lekeapparater hvor det er stor bevegelse, f.eks. ved huskestativ.
- Det bør være fritt innsyn til lekeutstyr som er beregnet for barn under 3 år.

**NB! Under monteringsarbeidet må utstyr, som ikke er forankret forsvarlig i bakken, sikres slik at det ikke velte. Området må avstenges under montering av apparatene med sperrebånd eller lignende.**

**EN**

- Read the instruction carefully before assembling the play unit.
- Assemble the components in the sequence shown in these instructions. Fixings must not be fully tightened during assembly. Before casting the foundations, the structure must be level and plumb, at which point all fixings are tightened. PS! If use of drill, the bolts may be wrecked.
- Avoid positioning the slide facing due south because of overheating – ideal positions are facing north-east or north-west. Secure the construction-area to prevent people from walking through it.
- Consider installing barriers around play-equipment which gives rise to a lot of activity – i.e. swings.
- Ensure that clear vision is possible across the play area so that supervision is possible from any position, particularly where children under 3 years of age will be playing.

**NB! During assembly of the equipment, ensure that all structures are securely propped, especially when left overnight. Also ensure that equipment is supported**

**Monteringstips / Assembly Advice / Monteringsstips****S**

- Läs monteringsanvisningen noga före montering.

- Montera delarna i den ordningen som anvisas
- Skruvarna bör inte skruvas för hårt tills allt är monterat, i våg och lodat.

OBS! Används elektrisk skruvdragare, kan bulten gå sönder. Hårdra därför manuellt!











- Solen kan göra att rutchbanan blir väldigt varm. Banans nedfart rekommenderas att vändas i norrlig riktning
- Om lekplatsen placeras vid en gångväg mm bör området säkras mot genomfart av gående och cyklister.
- Insprängningshinder bör placeras runt lekutrustning med stor rörelse, t ex, gungställning.
- Det bör vara fri insyn till lekutrustning beräknat till barn under 3 år.

**OBS! Under monteringsarbete bör utrustningen som inte ska förankras i marken, ställs så att den inte kan välta.**

**Området måste spärras när lekutrustningen byggs upp, med avspärrningsband eller liknande.**

NO	Betongkvalitet	C25/30			
SE	Betongkvalitet				
EN	Concrete quality				
NO	Mengde betong				m <sup>3</sup>
SE	Mängd betong				
EN	Amount of concrete				
NO	Fundament størrelse				m
SE	Stiftelsestorlek				
EN	Foundation size				
NO	For sikkerhet må fundamentene med sand eller myk jord være minst 50% større i areal				
SE	För säkerheten måste grunden med sand eller mjuk jord vara minst 50% större i området				
EN	For safety, the foundations with sand or soft soil must be at least 50% larger in area				
NO	Tyngste element	03-200-416	207		Kg
SE	Tyngsta element				
EN	Heaviest element				
NO	Største element	03-200-416	6,1x1x0,8		m
SE	Största element				
EN	Biggest element				

**Nødvendig verktøy / Tools required / Nödvändiga verktyg**

<p>(N)</p> <p>(EN)</p> <p>(S)</p>	<p>(A)</p> 	<p>(B)</p>  <p>Torx Nr 45 High quality</p> 	<p>(C)</p> <p>5 mm 6 mm</p> 	<p>(D)</p> 	<p>(E)</p> 
		<p>Metermål Metric measure Tumstock</p> 	<p>16 V</p> 	<p>Merkebånd Mark ribbon Märkeband</p> 	<p>13 + 17mm</p> 

**Nødvendig antall personer / Number of persons required / Lämpligt antal personer**



**Anbefalt arealbehov ved montering / Recommended working space / Rekommenderad arealbehov vid montering**

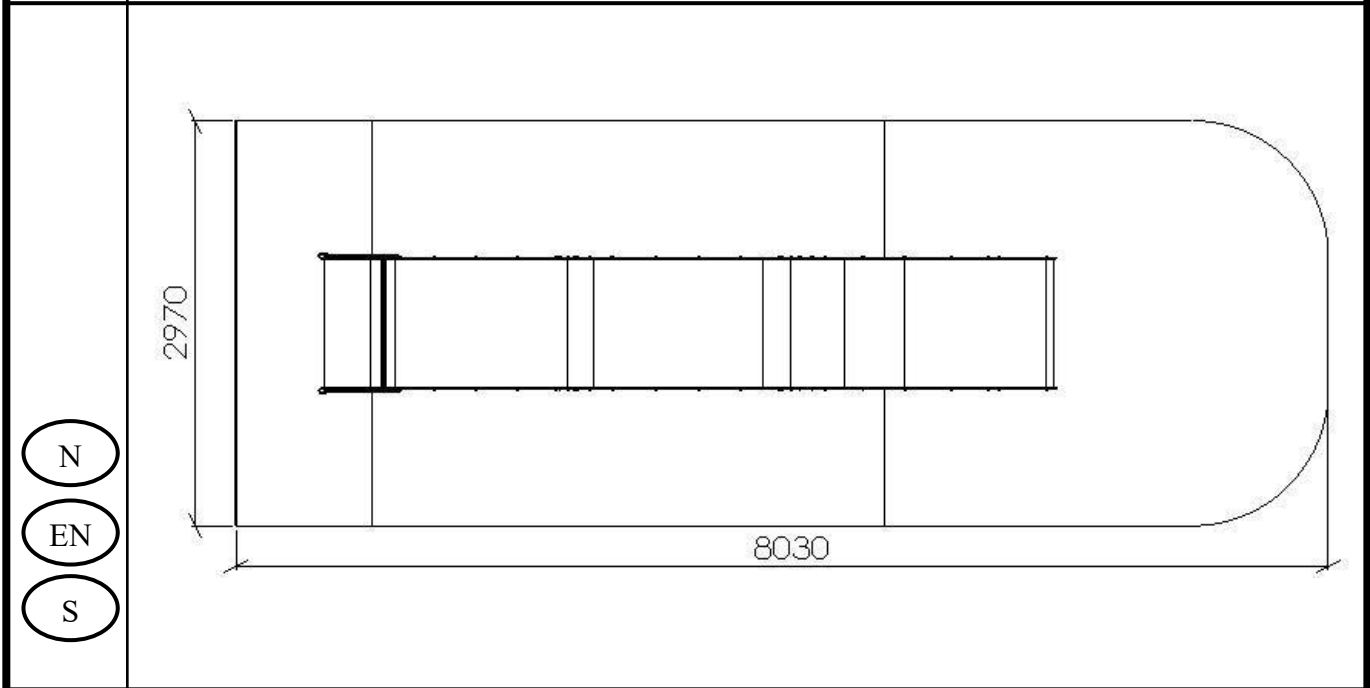



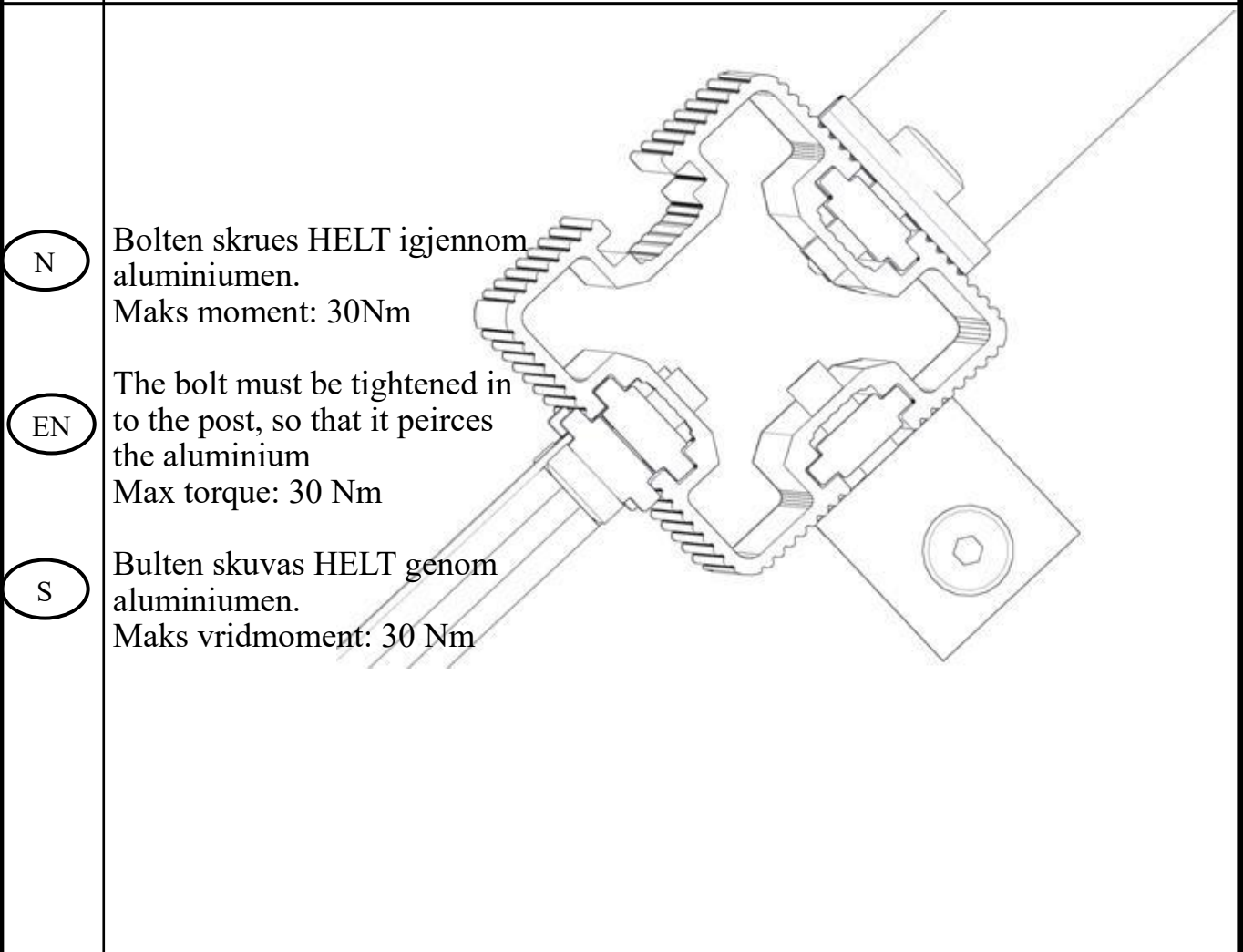
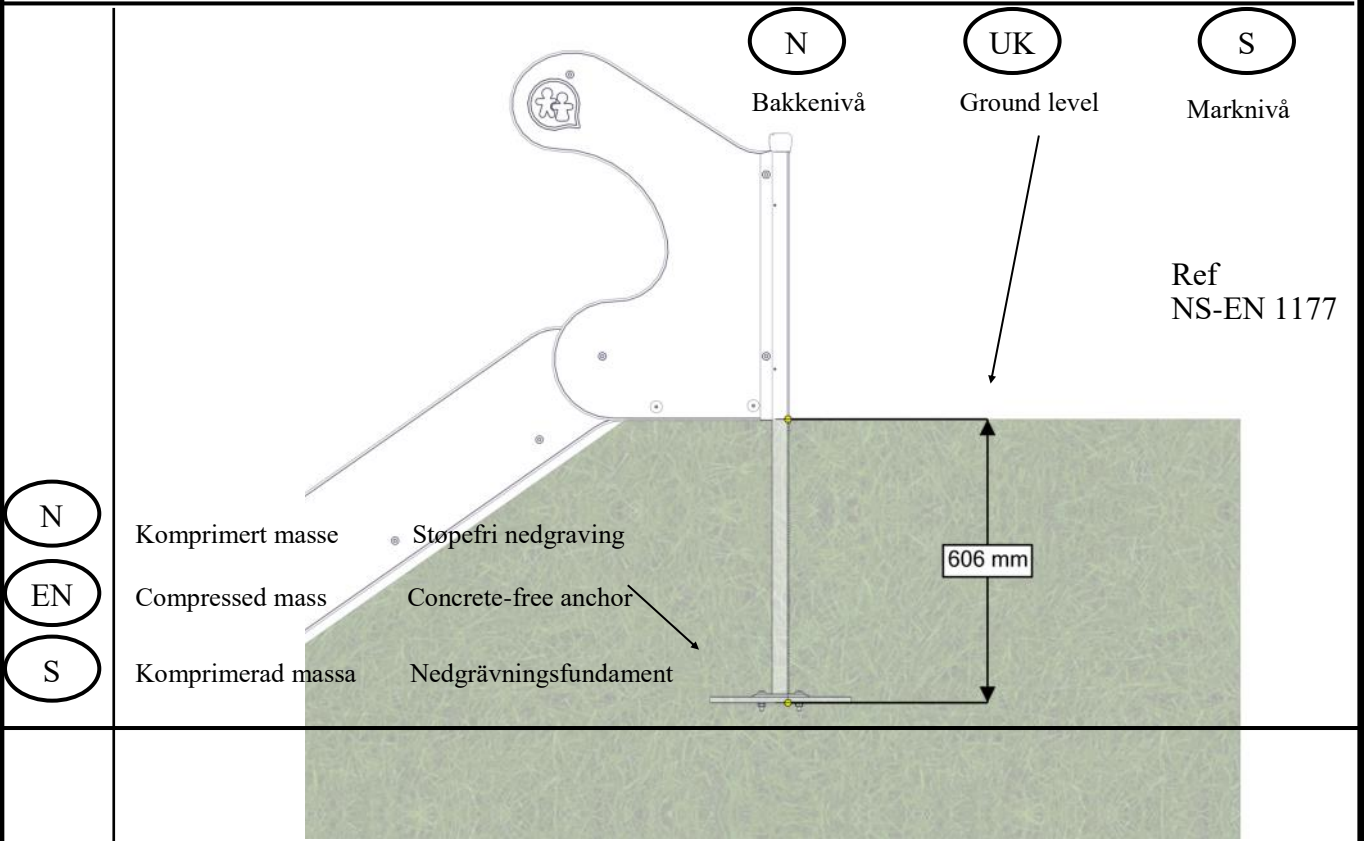

**Fundamentering uten betong / Foundation without concrete / Förankring utan betong**





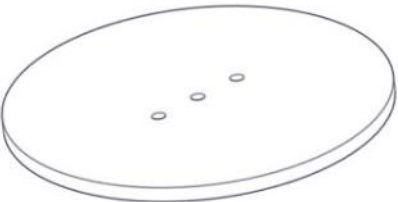

**Boltepakker for / Boltpackage for / Bultpaket för**

Sign. \_\_\_\_\_

Rutsjebane terreng 6,1 x 1,0 40-142-422	Navn	Artnr/ dimensjon	Ant	Lev
	Rutsjebane terreng 6,1 x 1,0 meter Rød	03-200-416	1	
	Stolpe venstre Gul	03-200-005	1	
	Stolpe høyre Gul	03-200-004	1	
	Fundament plate	00-003-103	6	
	Side topp høyre Gul	03-200-000	1	
	Side topp venstre Gul	03-200-001	1	

**Boltepakker for / Boltpackage for / Bultpaket för**

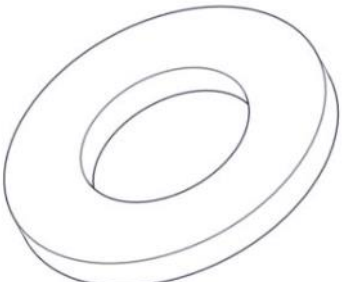

Sign. \_\_\_\_\_

Rutsjebane terreng 6,1 x 1,0 40-142-422	Navn	Artnr/ dimensjon	Ant	Lev
	Sperrerør for hylsemutter L=970 Gul	03-200-003	1	
	Stålforankring L=600	00-100-316	4	
	Torx M8 x 50 Torx M8 x 45 Torx M8 x 35 Torx M8 x 30	04-000-050 04-000-045 04-000-035 04-000-030	4 2 14 6	
	Torx M8 x 16	04-000-016	2	
	Låsemutter M8	04-040-008	16	
	Skive M8	04-050-008	34	

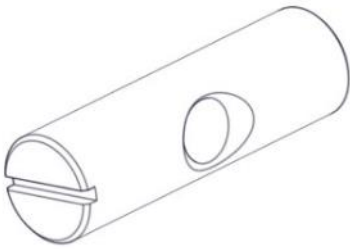

**Boltepakker for / Boltpackage for / Bultpaket för**

Sign. \_\_\_\_\_.

Rutsjebane terreng 6,1 x 1,0 40-142-422	Navn	Artnr/ dimensjon	Ant	Lev
	Møbelknapp M8 x 11 Møbelknapp M8 x 25	04-030-011 04-030-025	6 4	
	Hylsemutter Ø12 x 40 1 x M8	04-019-040	2	
	Merkeskilt	00-100-400 (Montert hos Søve)	0	

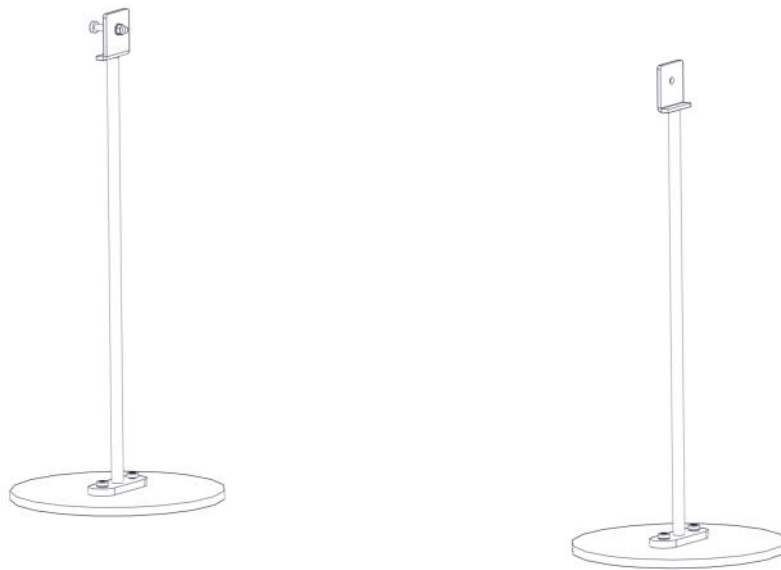

nr	PartName	Artnr	Antall
1	Fundament plate	00-003-103	4
2	Stålforankring L=600	00-100-316	4
3	Torx M8x35	04-000-035	8

nr	PartName	Artnr	Antall
4	Skive M8	04-050-008	16
5	Låsemutter M8	04-040-008	8

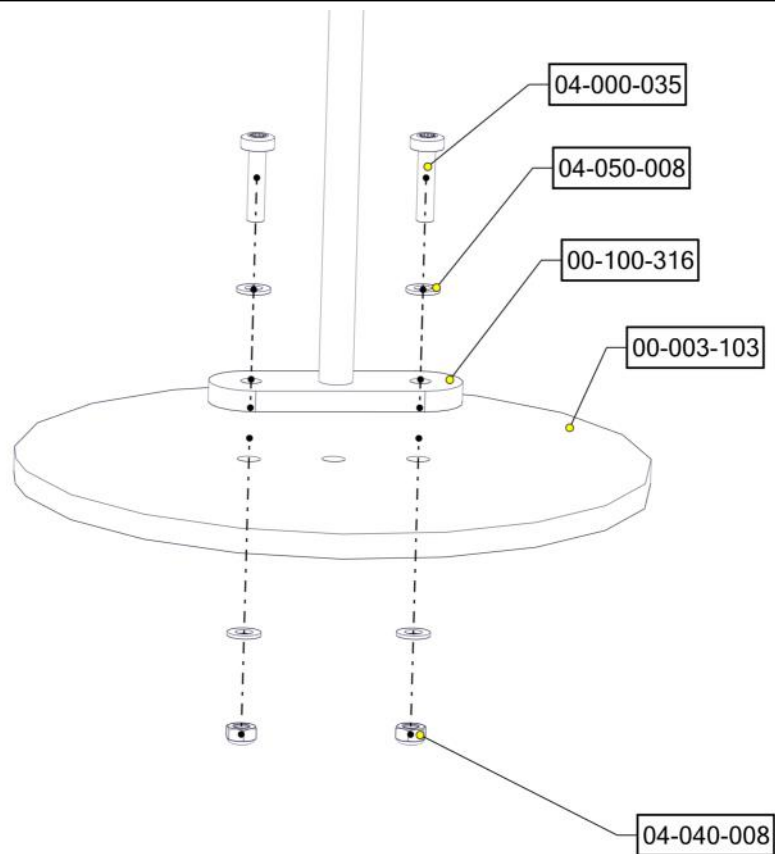

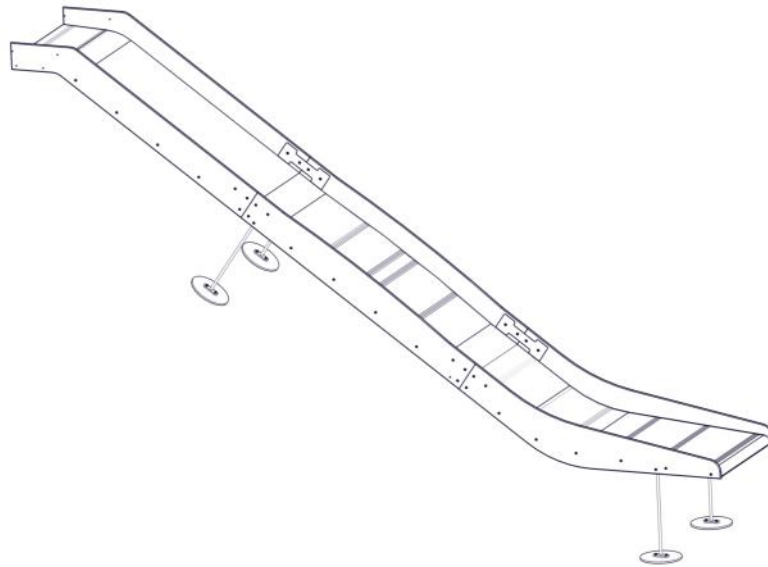

nr	PartName	Artnr	Antall
1	Låsemutter M8	04-040-008	4
2	Torx M8x	04-000-0	4
3	Skive M8	04-050-008	4
4	Rutsjebane terreng 6,1 x 1,0	03-200-416	1

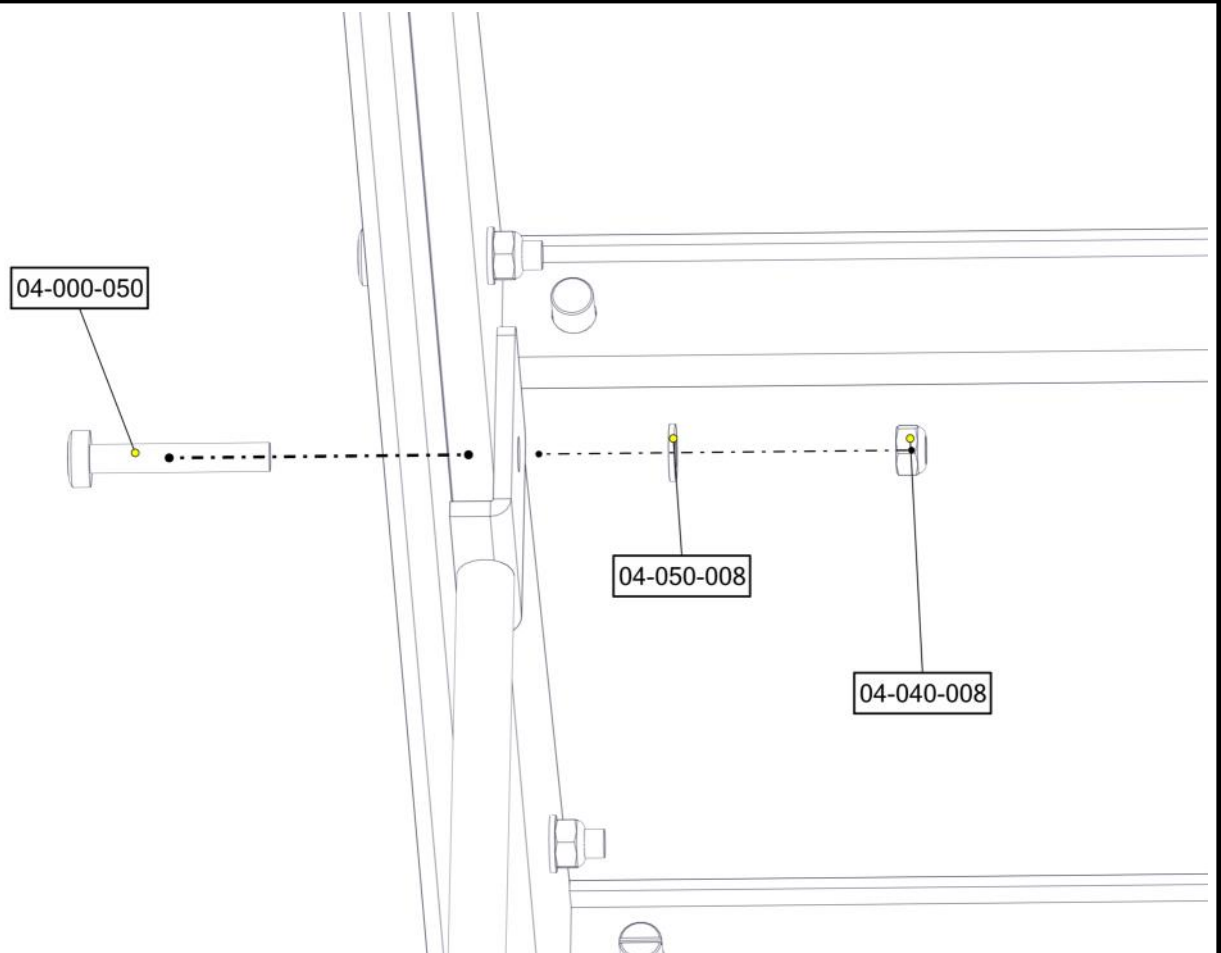

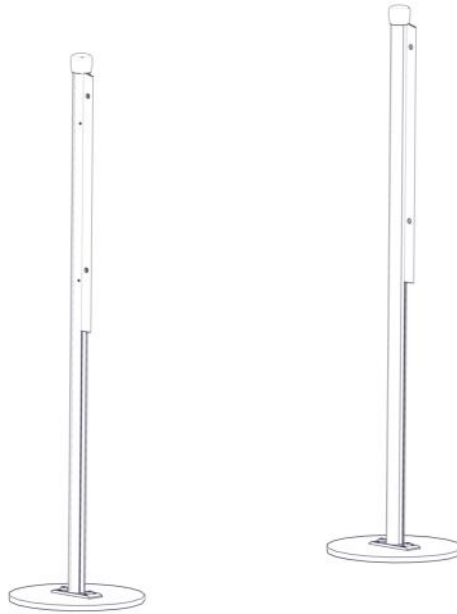

nr	PartName	Artnr	Antall
1	Rutsjebane Terreng - Stolpe Venstre	03-200-005	1
2	Rutsjebane Terreng - Stolpe Høyre	03-200-004	1
3	Fundament plate	00-003-103	2
4	Torx M8x35	04-000-035	4
5	Låsemutter M8	04-040-008	4
6	Skive M8	04-050-008	4

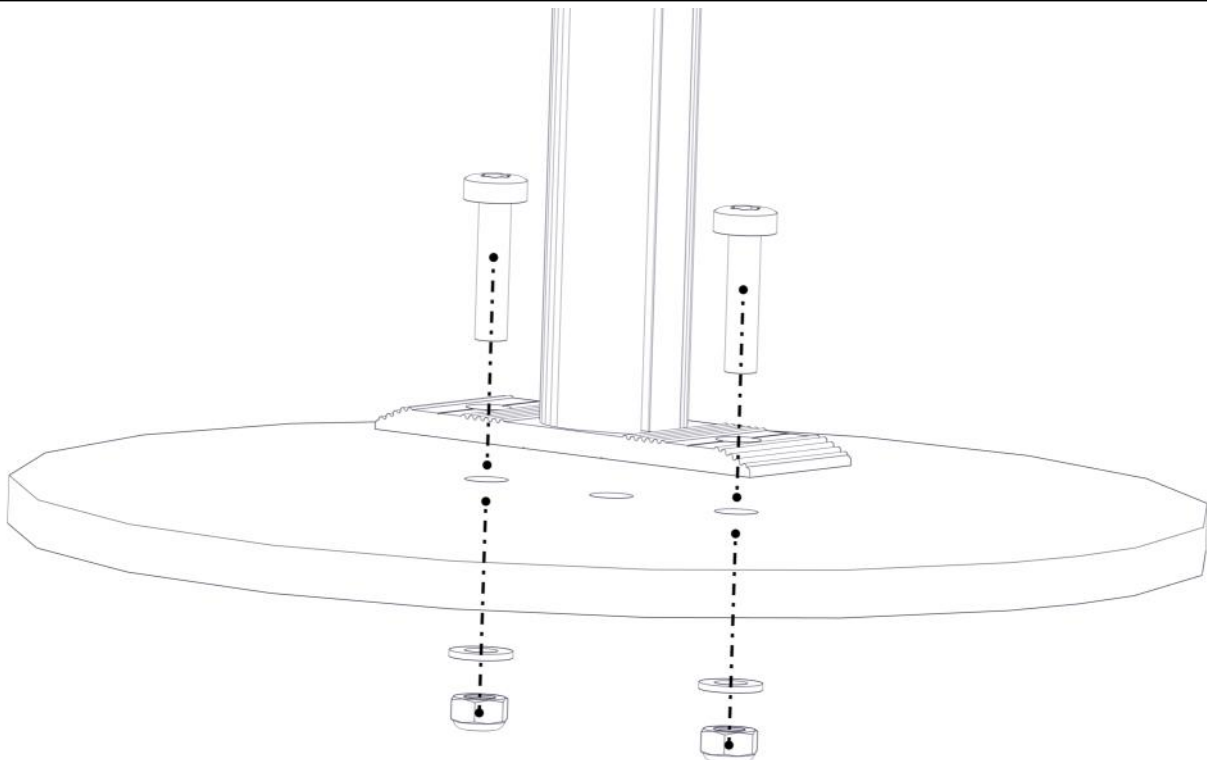

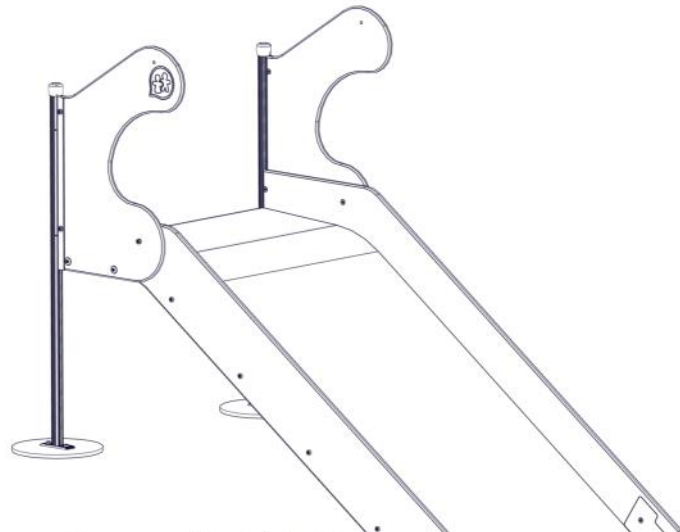

nr	PartName	Artnr	Antall
1	Rutsjebane Terreng Side Topp Venstre	03-200-001	1
2	Rutsjebane Terreng Side Topp Høyre	03-200-000	1
3	Møbelknapp M8x25	04-030-025	4
4	Møbelknapp M8x11	04-030-011	6
5	Torx M8x35	04-000-035	2

nr	PartName	Artnr	Antall
6	Torx M8x30	04-000-030	6
7	Torx M8x16	04-000-016	2
8	Skive M8	04-050-008	10

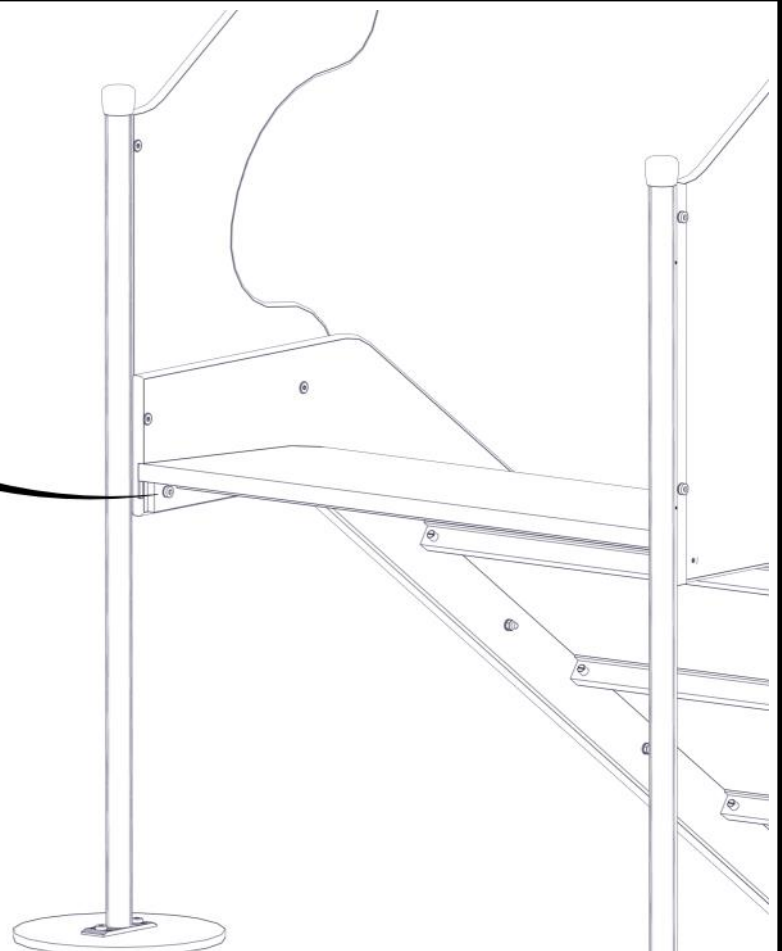
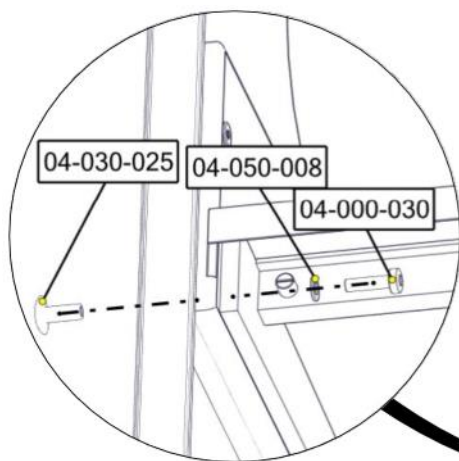

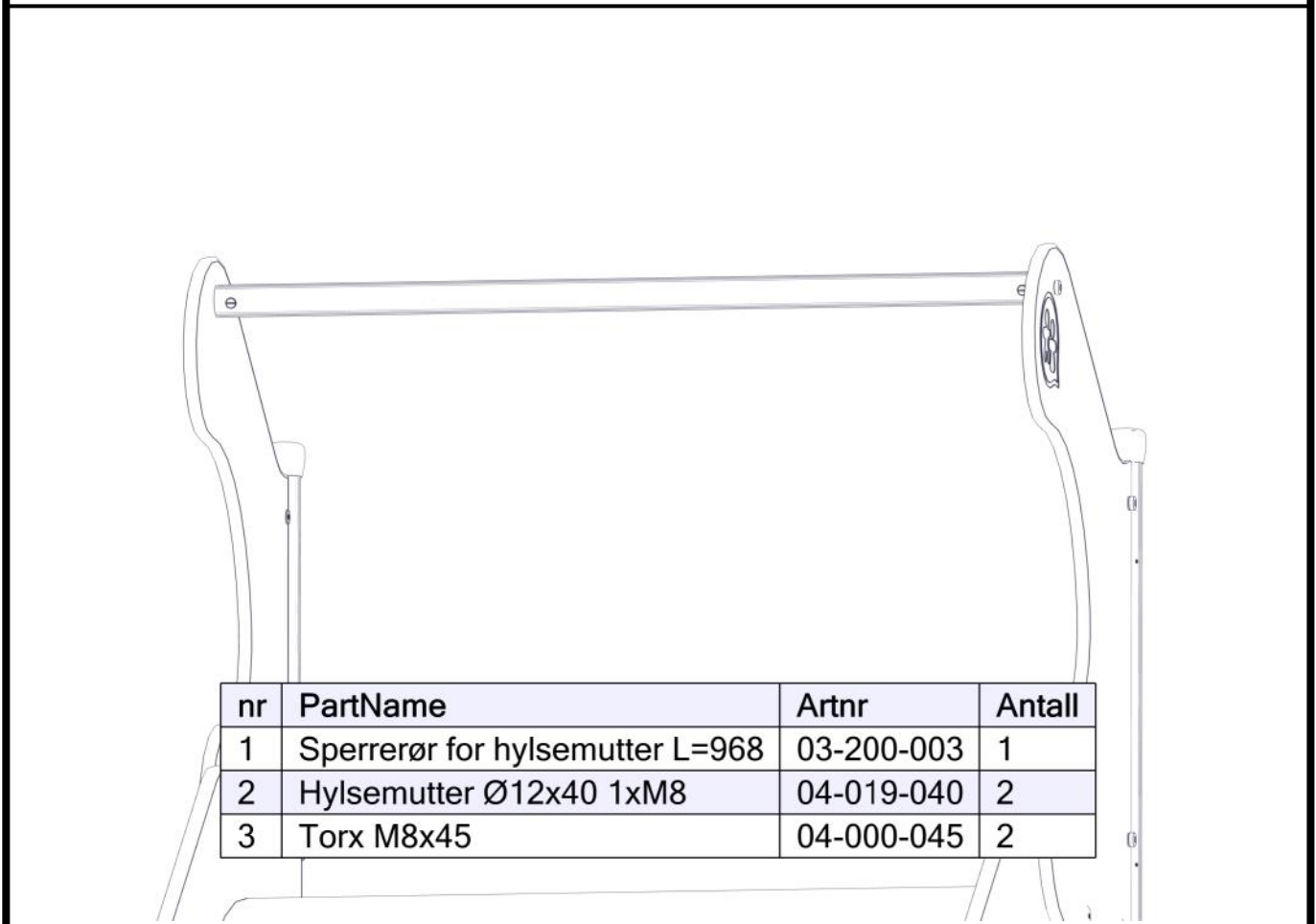
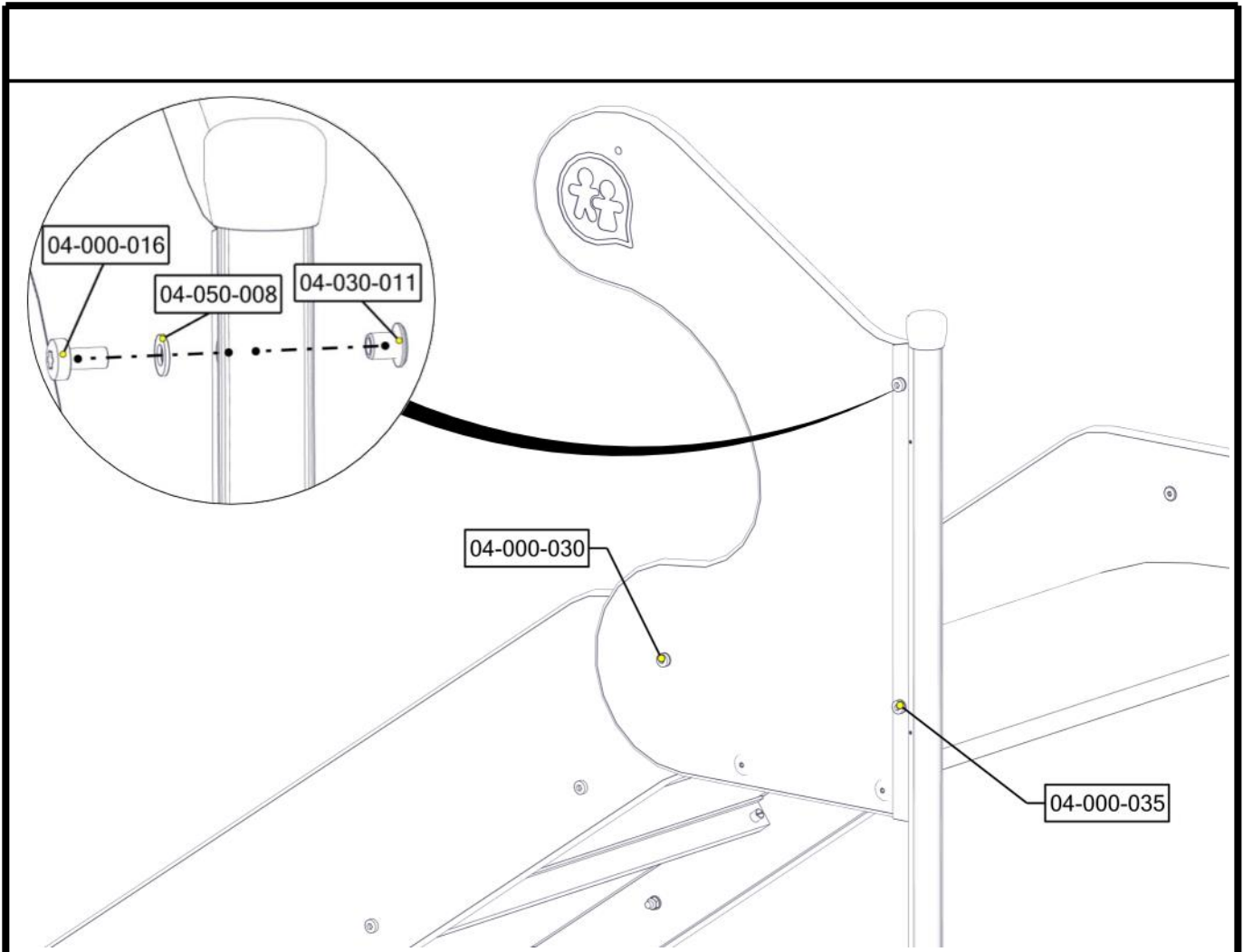

nr	PartName	Artnr	Antall
1	Sperrerør for hylsemutter L=968	03-200-003	1
2	Hylsemutter Ø12x40 1xM8	04-019-040	2
3	Torx M8x45	04-000-045	2

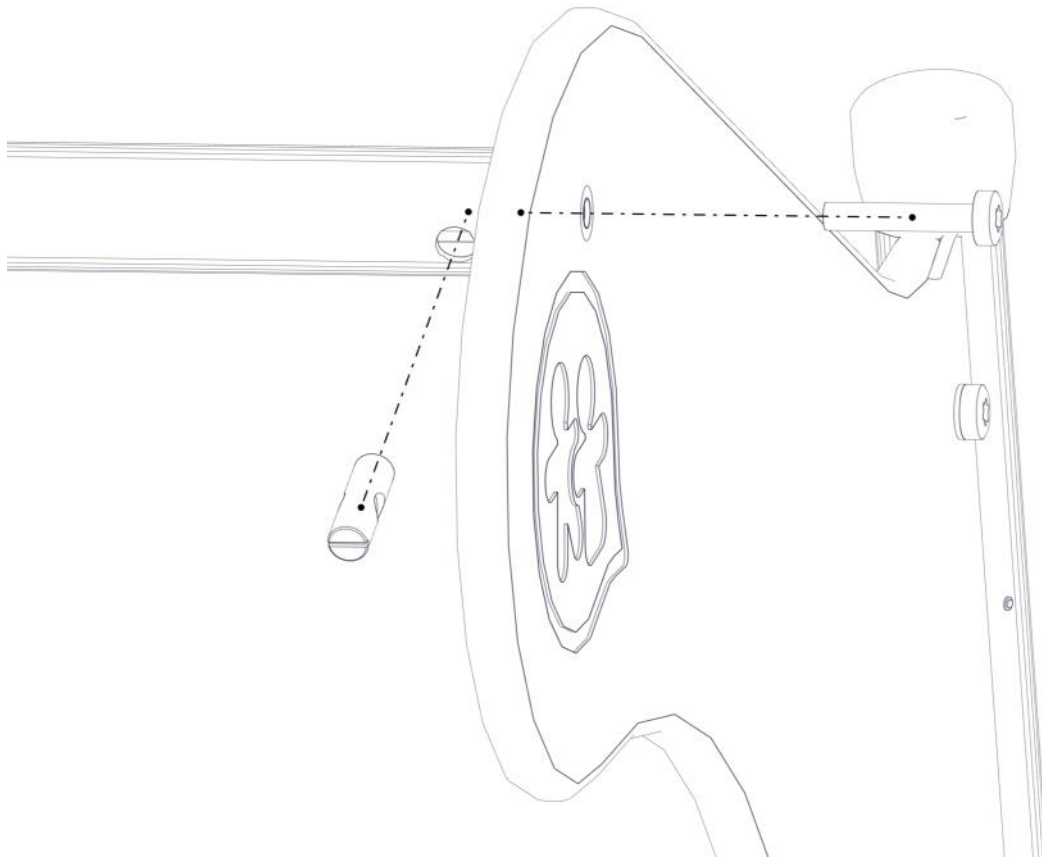

**Sikkerhets sone / Safety zone / Säkerhetszon**

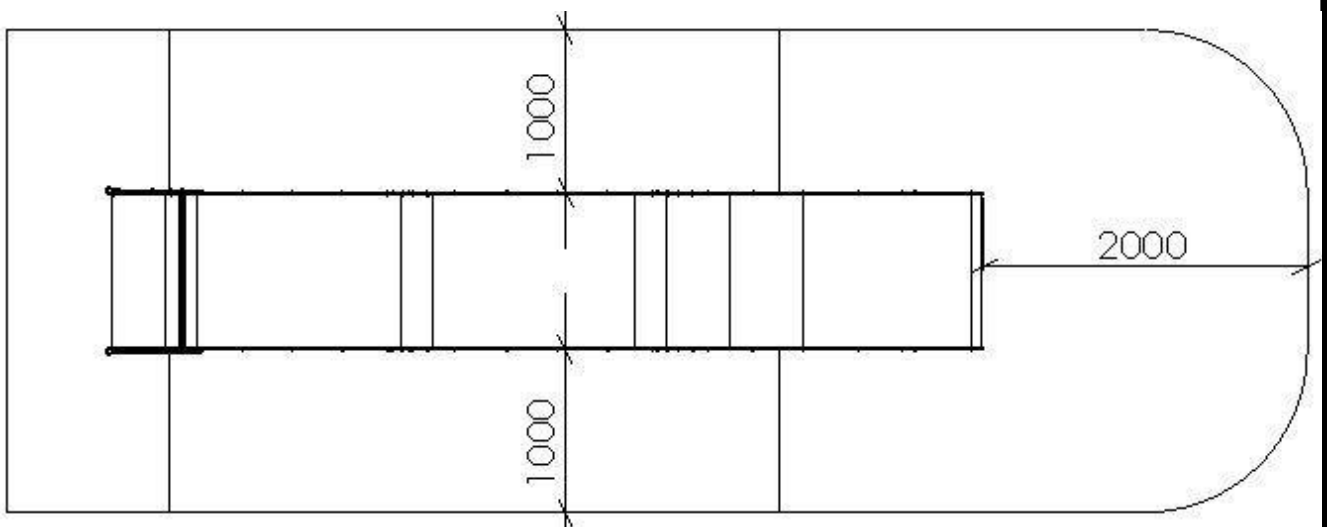









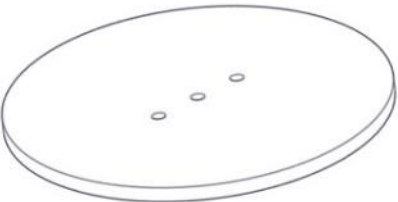

<b>Før utstyret tas i bruk / Before play begins / Innan lekredskapet tas i bruk</b>	
<b>N</b>	<ul style="list-style-type: none"> <li>● Påse at fallunderlag er utlagt i henhold til gjeldende regler eller vår anbefaling</li> <li>● Fjern alle monteringshjelpemidler ( rester av betong, planker, paller, plast, og lignende)</li> <li>● Før utstyret tas i bruk, burde man sjekke at det ikke er fare for at anorakksnorer og lignende som kan hekte seg fast noen steder på lekeapparatet. (Vedlagte snor med dobbe (kneledd) kan brukes til å sjekke at dette er i orden. Se vedlagte veiledning for bruk av denne. Dette gjøres for å oppdage eventuelle feilmonteringer.?)</li> <li>● NB! Bør stå i 2-3 dager før bruk</li> </ul>
<b>EN</b>	<ul style="list-style-type: none"> <li>● Make sure the area and depth of safer surfacing are according to the current standard, or to the manufacturer's recommendation</li> <li>● Make sure all tools and surplus materials are removed before play begins</li> <li>● PS! When complete, allow 2-3 days for the concrete to set before use</li> </ul>
<b>S</b>	<ul style="list-style-type: none"> <li>● Kontrollera att fallunderlag är utlagt enligt gällande regler eller vårt rekommendation</li> <li>● Ta bort alla monteringshjälpmedel (rester av betong, plankor, pallar, plast och liknande)</li> <li>● Innan lekredskapet används, kontrollera att anoracksnoddar eller kläder/delar av kläder eller liknande inte kan fastna i några delar på redskapet. (Den bipackade "knävringen" kan man med fördel användas för denna kontroll.</li> <li>● Detta görs för att upptäcka eventuella felmonteringar.)</li> </ul>



**Boltepakker for / Boltpackage for / Bultpaket för**

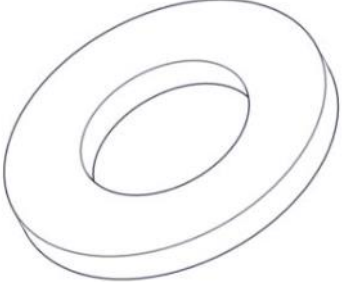

Sign. \_\_\_\_\_

Rutsjebane terreng 6,1 x 1,0 40-142-422	Navn	Artnr/ dimensjon	Ant	Lev
	Rutsjebane terreng 6,1 x 1,0 meter Rød	03-200-416	1	
	Stolpe venstre Gul	03-200-005	1	
	Stolpe høyre Gul	03-200-004	1	
	Fundament plate	00-003-103	6	
	Side topp høyre Gul	03-200-000	1	
	Side topp venstre Gul	03-200-001	1	

<b>Boltepakker for / Boltpackage for / Bultpaket för</b>		Sign. _____		
<b>Rutsjebane terreng 6,1 x 1,0 40-142-422</b>	<b>Navn</b>	<b>Artnr/ dimensjon</b>	<b>Ant</b>	<b>Lev</b>
	Sperrerør for hylsemutter L=970 Gul	03-200-003	1	
	Stålforankring L=600	00-100-316	4	
	Torx M8 x 50	04-000-050	4	
	Torx M8 x 45	04-000-045	2	
	Torx M8 x 35	04-000-035	14	
	Torx M8 x 30	04-000-030	6	
	Torx M8 x 16	04-000-016	2	
	Låsemutter M8	04-040-008	16	
	Skive M8	04-050-008	34	

**Boltepakker for / Boltpackage for / Bultpaket för**

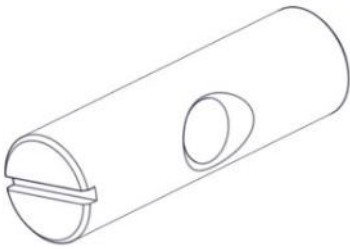
Sign. \_\_\_\_\_.

Rutsjebane terreng 6,1 x 1,0 40-142-422	Navn	Artnr/ dimensjon	Ant	Lev
	Møbelknapp M8 x 11  Møbelknapp M8 x 25	04-030-011  04-030-025	6  4	
	Hylsemutter Ø12 x 40 1 x M8	04-019-040	2	
	Merkeskilt	00-100-400 (Montert hos Søve)	0	

Revidert:

29.01.2020

Satt inn tabell (s.4) for største del (mål, vekt og delenummer)

MTK: 20-10-2020

Produktmerking se også feil rapport 40586

03.05.2023 MNO

Forandret lengde av stålforankring til 600mm