

N**Monteringsanvisning****EN****Assembly Instructions****S****Monteringsanvisning**

Produkt nr. / Product no. / Produkt nr.

40-142-523**Grå**

Ord. nr. _____

Dato. _____

Sign. _____

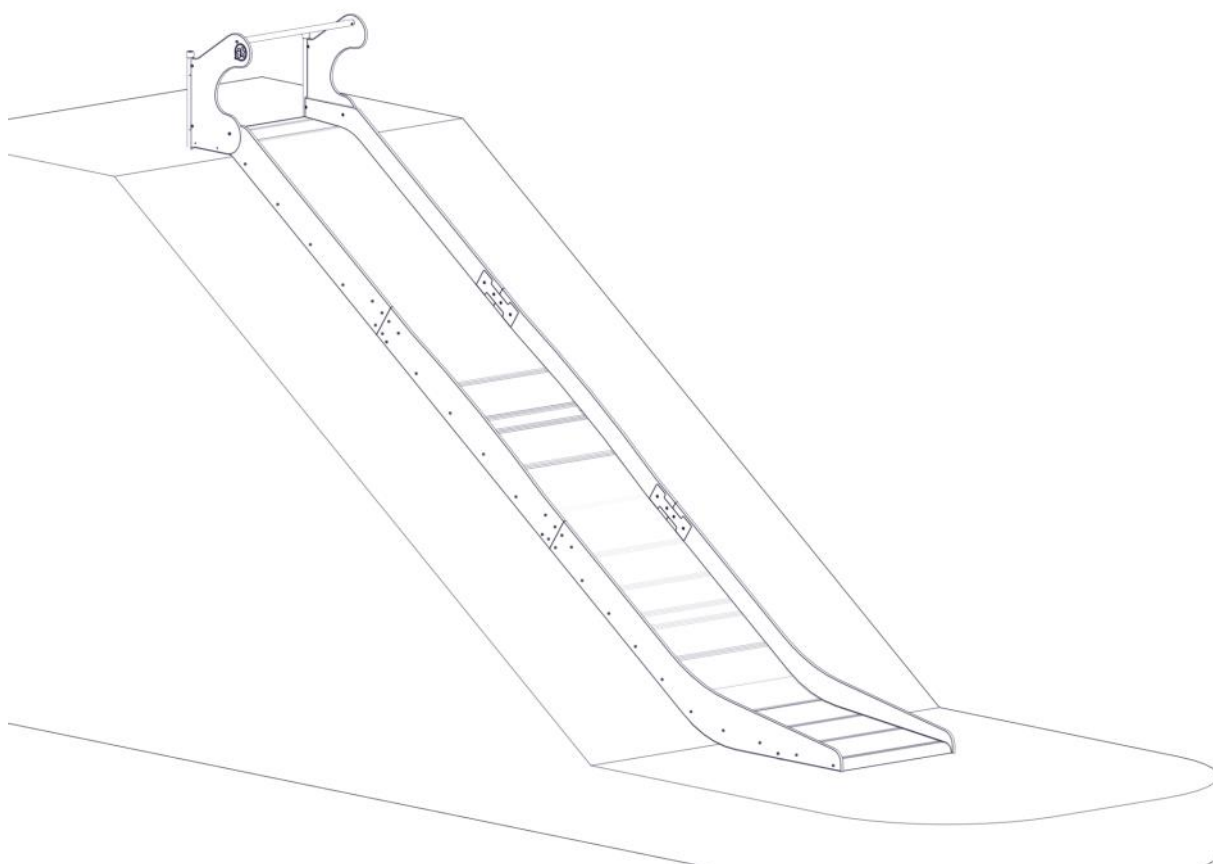
**sove**

Søve AS
Grønnvoldveien 290
3830 Ulefoss - Norway
Tlf: +47 35 94 65 65
www.sove.no

**söve**

Søve AB
EA Rosengrensgatan 32
421 31 Västra Frölunda
Phone: +46 (0)31 773 97 00
www.sove.se

Monteringstips / Assembly Advice / Monteringsstips

N

- Les monteringsanvisningen nøye før montering.
- Monter elementene i rekkefølgen som vist.
- Boltene bør ikke skrues for hardt til før alt er montert, vatret og loddet. Skru så boltene til.
- NB! Ved bruk av drill, kan boltene ryke.
- På grunn av at solen kan gjøre rutsjeflaten veldig varm, bør rutsjebanens utløp vende mot nord-øst eller nord-vest.
- Er lekeutstyret plassert i naturlige ferdselstraséer må området sikres mot gjennomgang.
- Innspringningshinder bør vurderes rundt lekeapparater hvor det er stor bevegelse, f.eks. ved huskestativ.
- Det bør være fritt innsyn til lekeutstyr som er beregnet for barn under 3 år.

NB! Under monteringsarbeidet må utstyr, som ikke er forankret forsvarlig i bakken, sikres slik at det ikke velte. Området må avstenges under montering av apparatene med sperrebånd eller lignende.

EN

- Read the instruction carefully before assembling the play unit.
- Assemble the components in the sequence shown in these instructions. Fixings must not be fully tightened during assembly. Before casting the foundations, the structure must be level and plumb, at which point all fixings are tightened. PS! If use of drill, the bolts may be wrecked.
- Avoid positioning the slide facing due south because of overheating – ideal positions are facing north-east or north-west. Secure the construction-area to prevent people from walking through it.
- Consider installing barriers around play-equipment which gives rise to a lot of activity – i.e. swings.
- Ensure that clear vision is possible across the play area so that supervision is possible from any position, particularly where children under 3 years of age will be playing.

NB! During assembly of the equipment, ensure that all structures are securely propped, especially when left overnight. Also ensure that equipment is supported

Monteringstips / Assembly Advice / Monteringsstips**S**

- Läs monteringsanvisningen noga före montering.

- Montera delarna i den ordningen som anvisas
- Skruvarna bör inte skruvas för hårt tills allt är monterat, i våg och lodat.

OBS! Används elektrisk skruvdragare, kan bulten gå sönder. Hårdra därför manuellt!











- Solen kan göra att rutchbanan blir väldigt varm. Banans nedfart rekommenderas att vändas i norrlig riktning
- Om lekplatsen placeras vid en gångväg mm bör området säkras mot genomfart av gående och cyklister.
- Insprängningshinder bör placeras runt lekutrustning med stor rörelse, t ex, gungställning.
- Det bör vara fri insyn till lekutrustning beräknat till barn under 3 år.

OBS! Under monteringsarbete bör utrustningen som inte ska förankras i marken, ställs så att den inte kan välta.

Området måste spärras när lekutrustningen byggs upp, med avspärrningsband eller liknande.

| | | | | | |
|----|--|------------|------------|----------------|--|
| NO | Betongkvalitet | C25/30 | | | |
| SE | Betongkvalitet | | | | |
| EN | Concrete quality | | | | |
| NO | Mengde betong | | | m ³ | |
| SE | Mängd betong | | | | |
| EN | Amount of concrete | | | | |
| NO | Fundament størrelse | | | m | |
| SE | Stiftelsestorlek | | | | |
| EN | Foundation size | | | | |
| NO | For sikkerhet må fundamentene med sand eller myk jord være minst 50% større i areal | | | | |
| SE | För säkerheten måste grunden med sand eller mjuk jord vara minst 50% större i området | | | | |
| EN | For safety, the foundations with sand or soft soil must be at least 50% larger in area | | | | |
| NO | Tyngste element | 03-200-518 | 275 | Kg | |
| SE | Tyngsta element | | | | |
| EN | Heaviest element | | | | |
| NO | Største element | 03-200-518 | 7,1x1x0,77 | m | |
| SE | Största element | | | | |
| EN | Biggest element | | | | |

Nødvendig verktøy / Tools required / Nödvändiga verktyg

| | | | | | |
|-----------------------------------|--|---|---|--|--|
| <p>(N)</p> <p>(EN)</p> <p>(S)</p> | <p>(A)</p>  | <p>(B)</p>  <p>Torx Nr 45 High quality</p> | <p>(C)</p> <p>5 mm 6 mm</p>  | <p>(D)</p>  | <p>(E)</p>  |
| |  | <p>Metermål Metric measure Tumstock</p>  | <p>16 V</p>  | <p>Merkebånd Mark ribbon Märkeband</p>  | <p>13 + 17mm</p>  |

Nødvendig antall personer / Number of persons required / Lämpligt antal personer



Anbefalt arealbehov ved montering / Recommended working space / Rekommenderad arealbehov vid montering

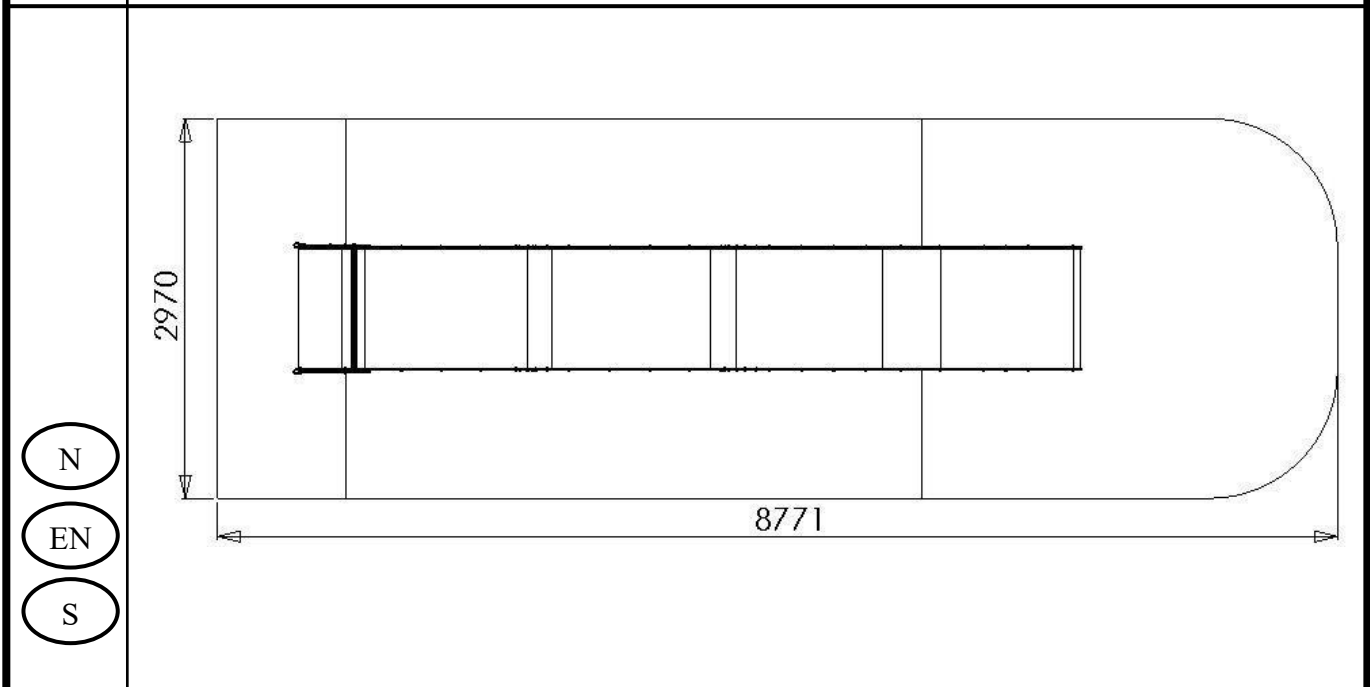



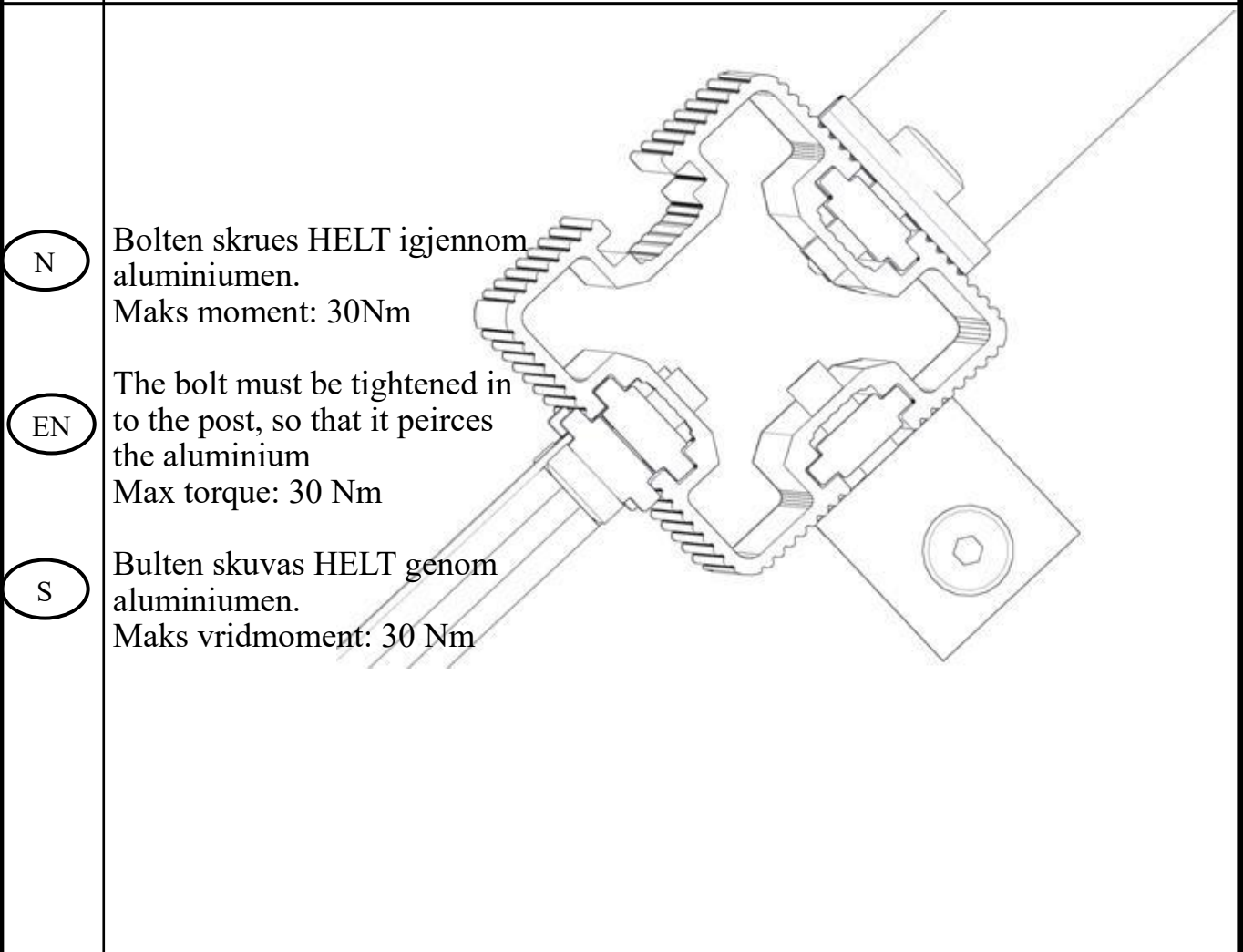
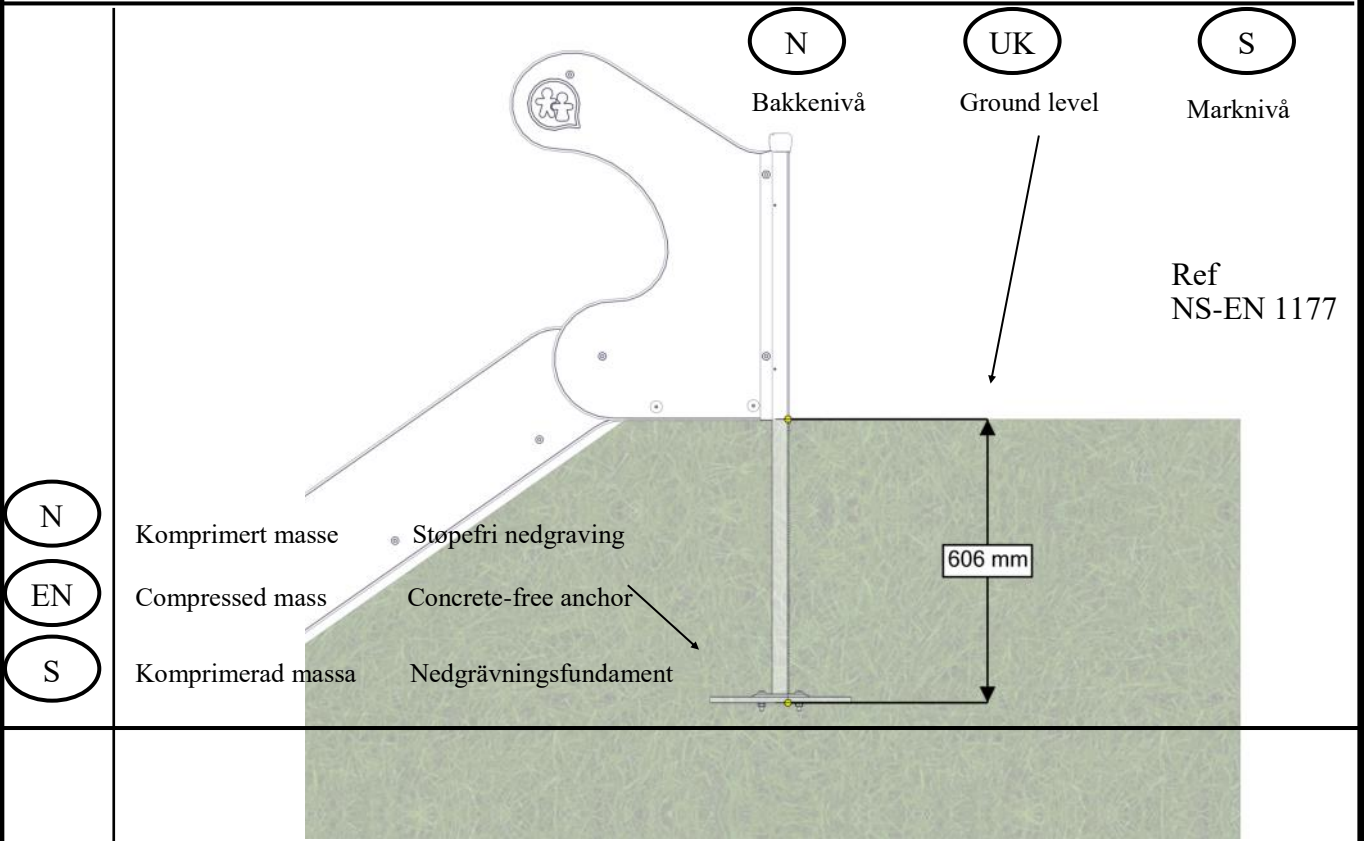

Fundamentering uten betong / Foundation without concrete / Förankring utan betong





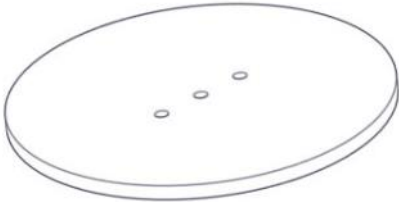

Boltepakker for / Boltpackage for / Bultpaket för

Sign. _____

| Rutsjebane terreng 7,1 x 1,0 40-142-523 | Navn | Artnr/ dimensjon | Ant | Lev |
|---|--|---------------------|-----|-----|
|  | Rutsjebane terreng 7,1 x 1,0 meter Grå | 03-200-518 | 1 | |
|  | Stolpe venstre Sort | 03-200-017 | 1 | |
|  | Stolpe høyre Sort | 03-200-018 | 1 | |
|  | Fundament plate | 00-003-103 | 8 | |
|  | Side topp høyre Grå | 03-200-016 | 1 | |
|  | Side topp venstre Grå | 03-200-015 | 1 | |

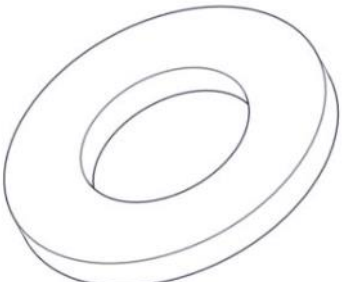

Boltepakker for / Boltpackage for / Bultpaket för

Sign. _____

| Rutsjebane terreng 7,1 x 1,0 40-142-523 | Navn | Artnr/ dimensjon | Ant | Lev |
|---|--|--|-------------------|-----|
|  | Sperrerør for hylsemutter L=970 Sort | 03-200-011 | 1 | |
|  | Stålforankring L=600 | 00-100-316 | 6 | |
|  | Torx M8 x 50 Torx M8 x 45 Torx M8 x 35 Torx M8 x 30 | 04-000-050 04-000-045 04-000-035 04-000-030 | 6 2 18 6 | |
|  | Torx M8 x 16 | 04-000-016 | 2 | |
|  | Låsemutter M8 | 04-040-008 | 22 | |
|  | Skive M8 | 04-050-008 | 44 | |

Boltepakker for / Boltpackage for / Bultpaket för

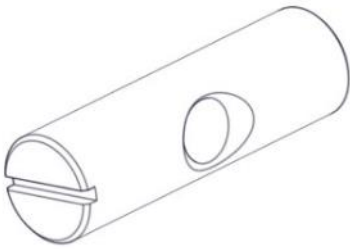
Sign. _____.

| Rutsjebane terreng 7,1 x 1,0 40-142-523 | Navn | Artnr/ dimensjon | Ant | Lev |
|--|--|----------------------------------|------------|-----|
|  | Møbelknapp M8 x 11 Møbelknapp M8 x 25 | 04-030-011 04-030-025 | 6 4 | |
|  | Hylsemutter Ø12 x 40 1 x M8 | 04-019-040 | 2 | |
|  | Merkeskilt | 00-100-400 (Montert hos Søve) | 0 | |
| | | | | |
| | | | | |
| | | | | |

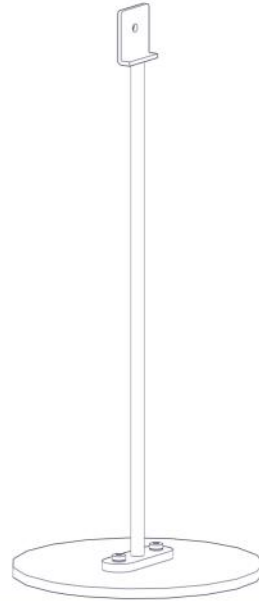
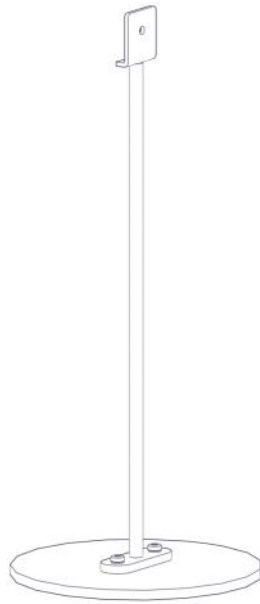

| nr | PartName | Artnr | Antall |
|----|---------------|------------|--------|
| 1 | Torx M8x35 | 04-000-035 | 12 |
| 2 | Skive M8 | 04-050-008 | 24 |
| 3 | Låsemutter M8 | 04-040-008 | 12 |

| nr | PartName | Artnr | Antall |
|----|----------------------|------------|--------|
| 4 | Fundament plate | 00-003-103 | 6 |
| 5 | Stålforankring L=600 | 00-100-316 | 6 |

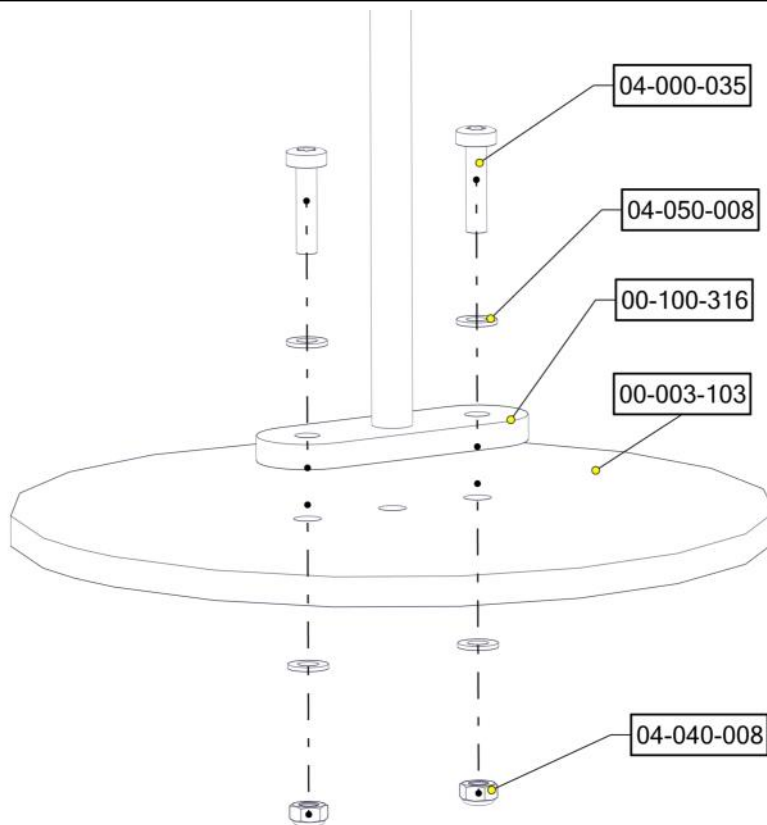

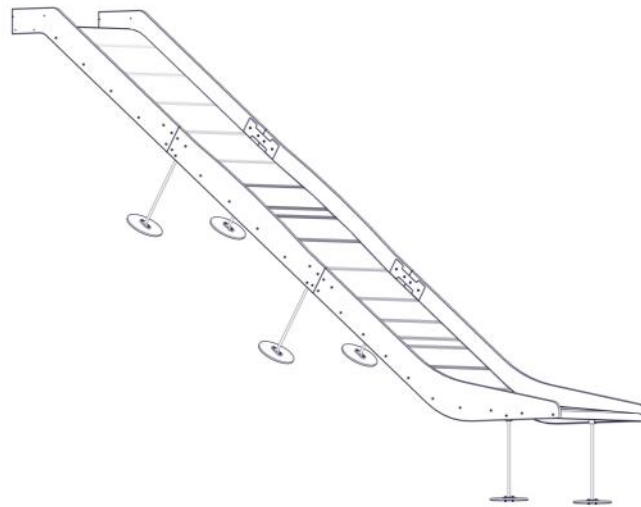

| nr | PartName | Artnr | Antall |
|----|------------------------------|------------|--------|
| 1 | Rutsjebane terreng 7,1 x 1,0 | 03-200-518 | 1 |
| 2 | Torx M8x | 04-000-0 | 6 |
| 3 | Låsemutter M8 | 04-040-008 | 6 |
| 4 | Skive M8 | 04-050-008 | 6 |

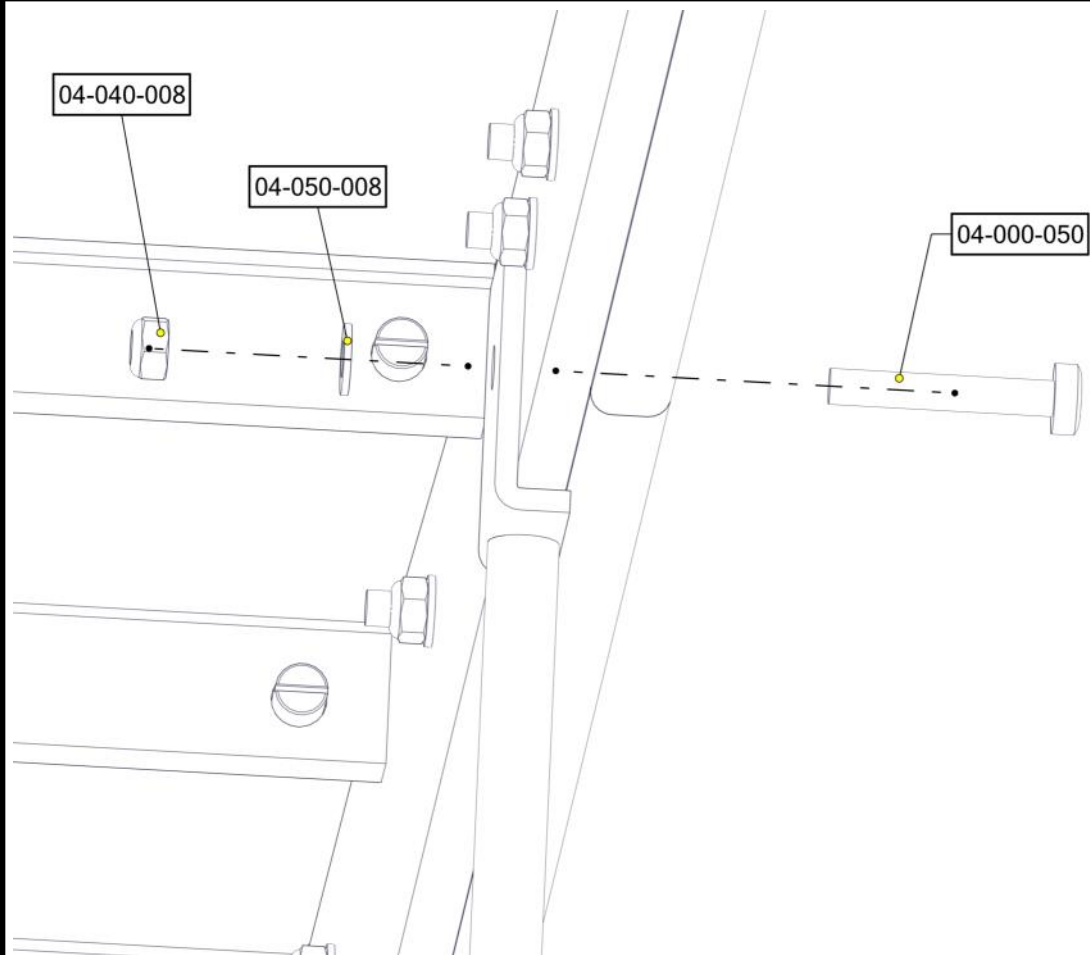



| nr | PartName | Artnr | Antall |
|----|-------------------------------------|------------|--------|
| 1 | Fundament plate | 00-003-103 | 2 |
| 2 | Torx M8x35 | 04-000-035 | 4 |
| 3 | Låsemutter M8 | 04-040-008 | 4 |
| 4 | Skive M8 | 04-050-008 | 4 |
| 5 | Rutsjebane Terreng - Stolpe Venstre | 03-200-017 | 1 |
| 6 | Rutsjebane Terreng - Stolpe Høyre | 03-200-018 | 1 |

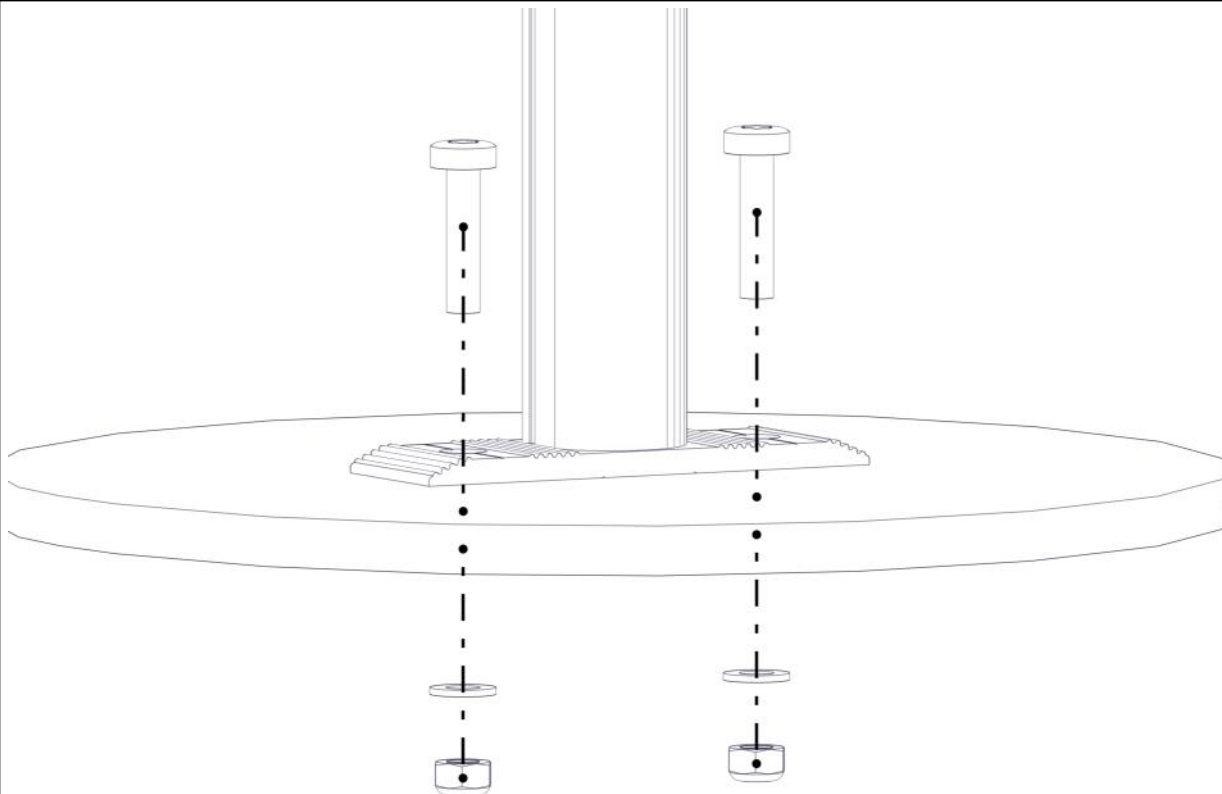

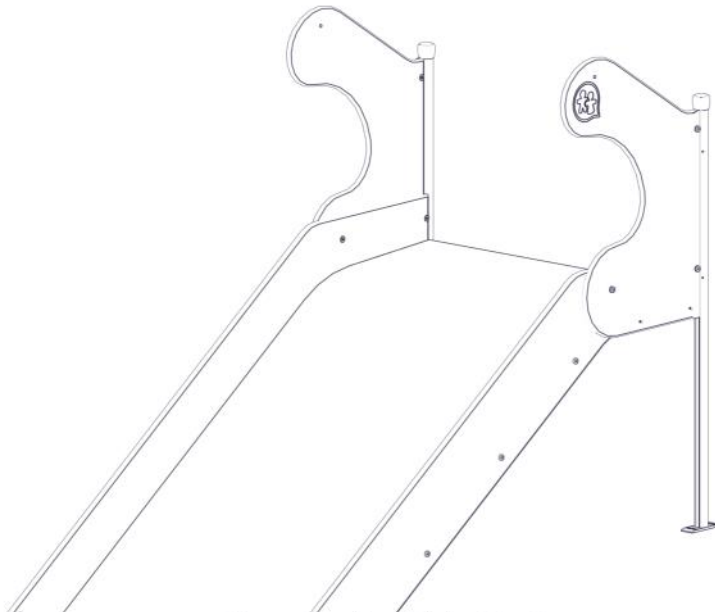

| nr | PartName | Artnr | Antall |
|----|--------------------------------------|------------|--------|
| 1 | Møbelknapp M8x11 | 04-030-011 | 6 |
| 2 | Møbelknapp M8x25 | 04-030-025 | 4 |
| 3 | Rutsjebane Terreng Side Topp Høyre | 03-200-016 | 1 |
| 4 | Rutsjebane Terreng Side Topp Venstre | 03-200-015 | 1 |
| 5 | Skive M8 | 04-050-008 | 10 |

| nr | PartName | Artnr | Antall |
|----|------------|------------|--------|
| 6 | Torx M8x16 | 04-000-016 | 2 |
| 7 | Torx M8x30 | 04-000-030 | 6 |
| 8 | Torx M8x35 | 04-000-035 | 2 |

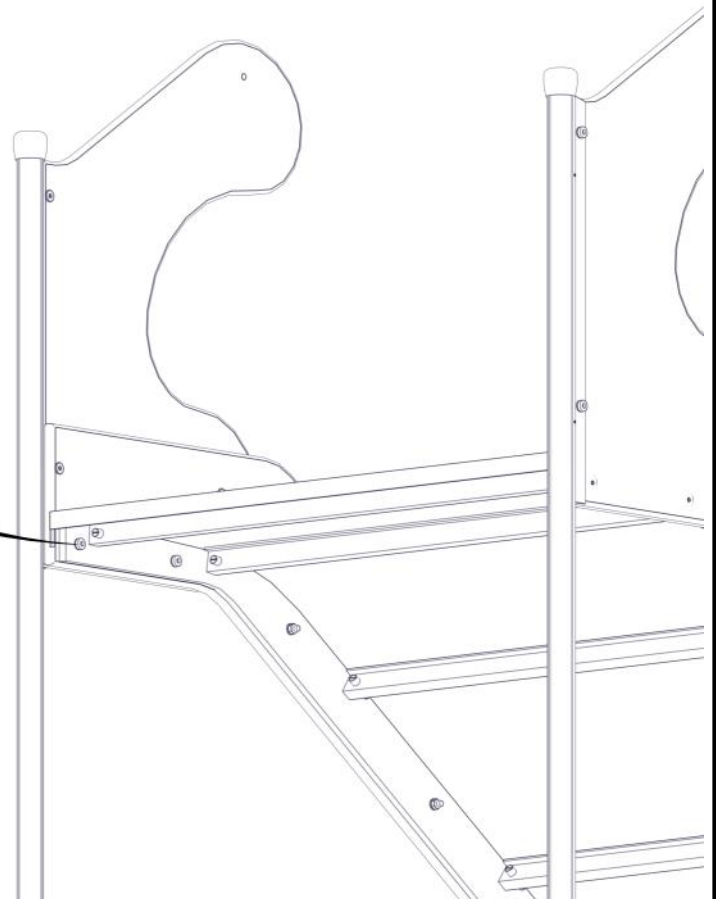
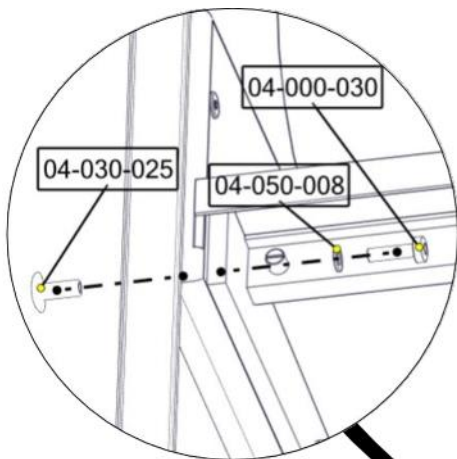

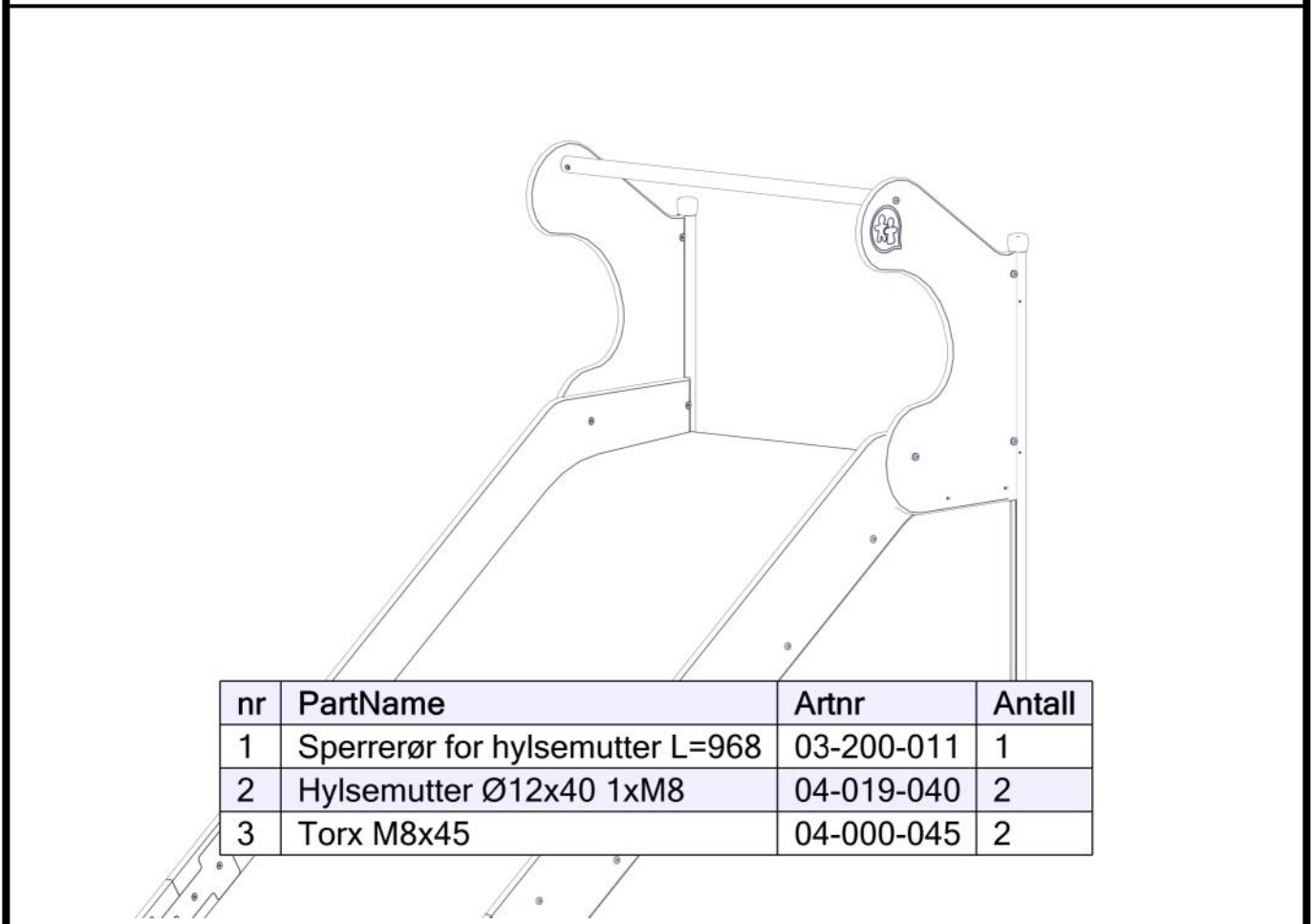
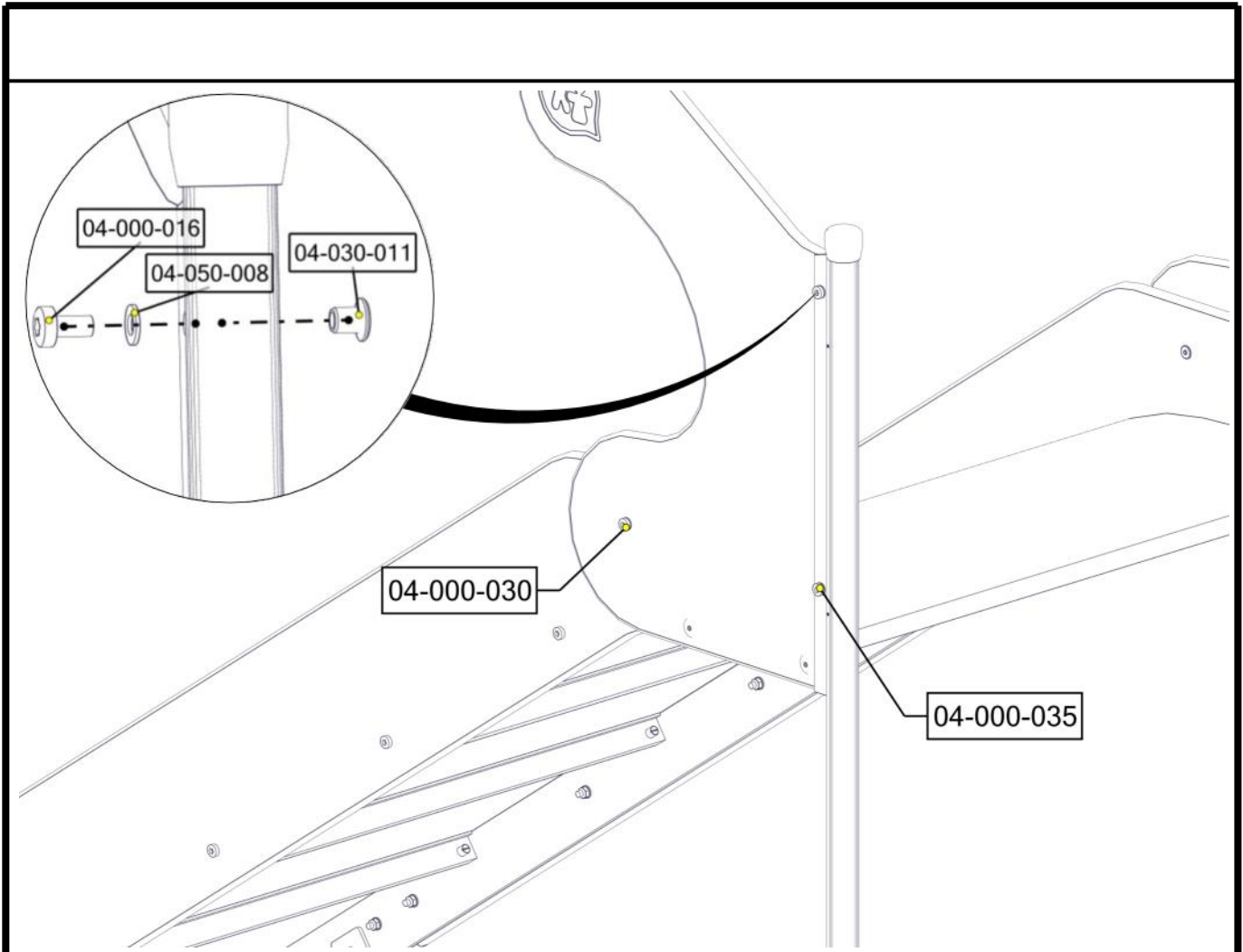

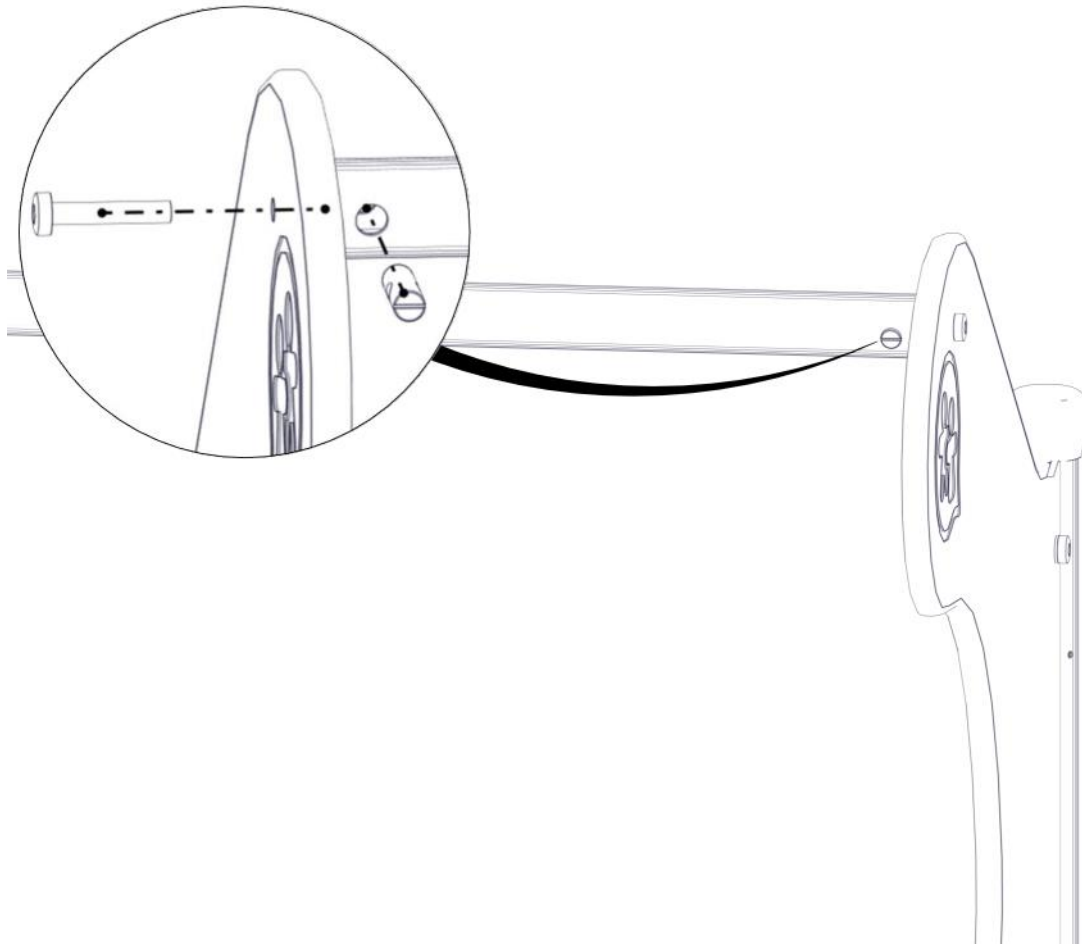



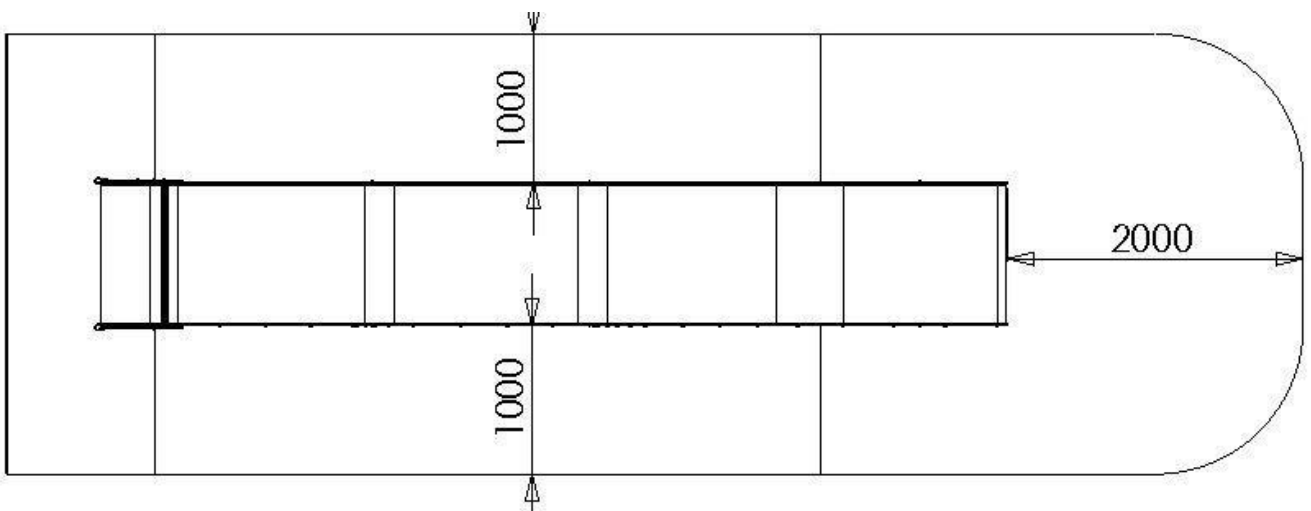

Sikkerhets sone / Safety zone / Säkerhetszon







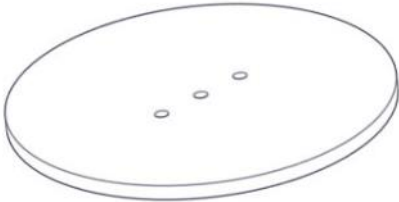



| Før utstyret tas i bruk / Before play begins / Innan lekredskapet tas i bruk | |
|---|--|
| N | <ul style="list-style-type: none"> ● Påse at fallunderlag er utlagt i henhold til gjeldende regler eller vår anbefaling ● Fjern alle monteringshjelpemidler (rester av betong, planker, paller, plast, og lignende) ● Før utstyret tas i bruk, burde man sjekke at det ikke er fare for at anorakksnorer og lignende som kan hekte seg fast noen steder på lekeapparatet. (Vedlagte snor med dobbe (kneledd) kan brukes til å sjekke at dette er i orden. Se vedlagte veiledning for bruk av denne. Dette gjøres for å oppdage eventuelle feilmonteringer.?) ● NB! Bør stå i 2-3 dager før bruk |
| EN | <ul style="list-style-type: none"> ● Make sure the area and depth of safer surfacing are according to the current standard, or to the manufacturer's recommendation ● Make sure all tools and surplus materials are removed before play begins ● PS! When complete, allow 2-3 days for the concrete to set before use |
| S | <ul style="list-style-type: none"> ● Kontrollera att fallunderlag är utlagt enligt gällande regler eller vårt rekommendation ● Ta bort alla monteringshjälpmedel (rester av betong, plankor, pallar, plast och liknande) ● Innan lekredskapet används, kontrollera att anoracksnoddar eller kläder/delar av kläder eller liknande inte kan fastna i några delar på redskapet. (Den bipackade "knävringen" kan man med fördel användas för denna kontroll. ● Detta görs för att upptäcka eventuella felmonteringar.) |

Boltepakker for / Boltpackage for / Bultpaket för

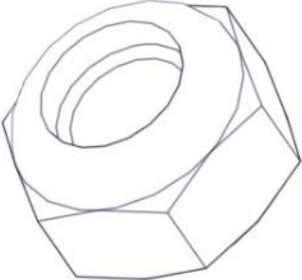
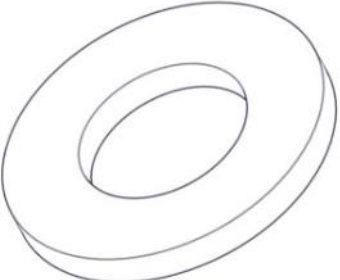
Sign. _____

| Rutsjebane terreng 7,1 x 1,0 40-142-523 | Navn | Artnr/ dimensjon | Ant | Lev |
|---|--|---------------------|-----|-----|
|  | Rutsjebane terreng 7,1 x 1,0 meter Grå | 03-200-518 | 1 | |
|  | Stolpe venstre Sort | 03-200-017 | 1 | |
|  | Stolpe høyre Sort | 03-200-018 | 1 | |
|  | Fundament plate | 00-003-103 | 8 | |
|  | Side topp høyre Grå | 03-200-016 | 1 | |
|  | Side topp venstre Grå | 03-200-015 | 1 | |

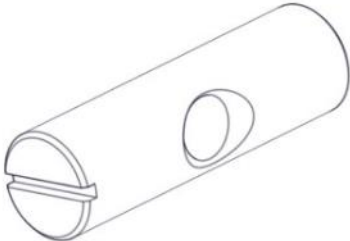
| Boltepakker for / Boltpackage for / Bultpaket för | | Sign. _____ | | |
|---|--|-----------------------------|------------|------------|
| Rutsjebane terreng 7,1 x 1,0 40-142-523 | Navn | Artnr/ dimensjon | Ant | Lev |
|  | Sperrerør for hylsemutter L=970 Sort | 03-200-011 | 1 | |
|  | Stålforankring L=600 | 00-100-316 | 6 | |
|  | Torx M8 x 50 | 04-000-050 | 6 | |
| | Torx M8 x 45 | 04-000-045 | 2 | |
| | Torx M8 x 35 | 04-000-035 | 18 | |
| | Torx M8 x 30 | 04-000-030 | 6 | |
|  | Torx M8 x 16 | 04-000-016 | 2 | |
|  | Låsemutter M8 | 04-040-008 | 22 | |
|  | Skive M8 | 04-050-008 | 44 | |

| Boltepakker for / Boltpackage for / Bultpaket för | | Sign. _____. | | |
|--|-----------------------------|----------------------------------|------------|------------|
| Rutsjebane terreng 7,1 x 1,0 40-142-523 | Navn | Artnr/ dimensjon | Ant | Lev |
|  | Møbelknapp M8 x 11 | 04-030-011 | 6 | |
| | Møbelknapp M8 x 25 | 04-030-025 | 4 | |
|  | Hylsemutter Ø12 x 40 1 x M8 | 04-019-040 | 2 | |
|  | Merkeskilt | 00-100-400 (Montert hos Søve) | 0 | |
| | | | | |
| | | | | |
| | | | | |

Revidert:

29.01.2020

Satt inn tabell (s.4) for største del (mål, vekt og delenummer)

MTK: 20-10-2020

Produktmerking se også feil rapport 40586

04.05.2023 MNO

Forandret lengde av stålforankring til 600mm