

N

Monteringsanvisning

EN

Assembly Instructions

S

Monteringsanvisning

Produkt nr. / Product no. / Produkt nr.

40-145-050

Ord. nr. _____

Dato. _____

Sign. _____

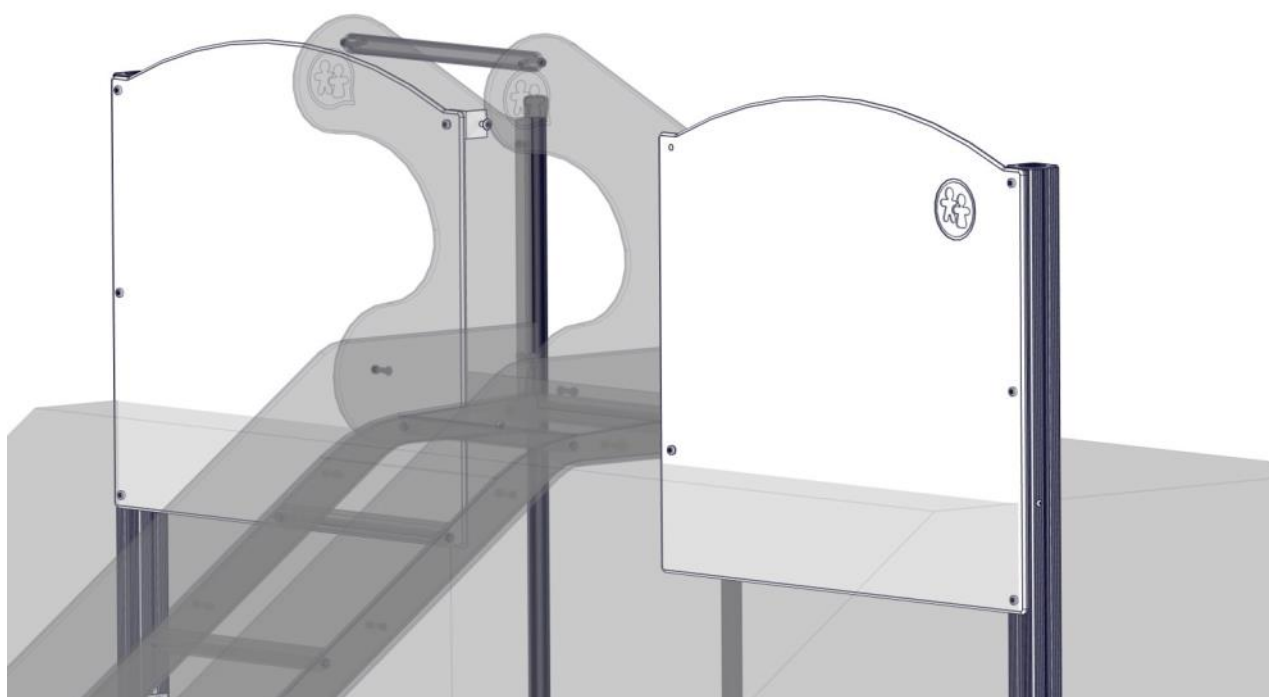
**søve**

Søve AS
Grønnvoldveien 290
3830 Ulefoss - Norway
Tlf: +47 35 94 65 65
www.sove.no

**søve**

Søve AB
EA Rosengrensgatan 32
421 31 Västra Frölunda
Phone: +46 (0)31 773 97 00
www.sove.se

Monteringstips / Assembly Advice / Monteringsstips

N

- Les monteringsanvisningen nøye før montering.
- Monter elementene i rekkefølgen som vist.
- Boltene bør ikke skrues for hardt til før alt er montert, vatret og loddet. Skru så boltene til.
- NB! Ved bruk av drill, kan boltene ryke.
- På grunn av at solen kan gjøre rutsjeflaten veldig varm, bør rutsjebanens utløp vende mot nord-øst eller nord-vest.
- Er lekeutstyret plassert i naturlige ferdselstraséer må området sikres mot gjennomgang.
- Innspringningshinder bør vurderes rundt lekeapparater hvor det er stor bevegelse, f.eks. ved huskestativ.
- Det bør være fritt innsyn til lekeutstyr som er beregnet for barn under 3 år.

NB! Under monteringsarbeidet må utstyr, som ikke er forankret forsvarlig i bakken, sikres slik at det ikke velte.

Området må avstenges under montering av apparatene med sperrebånd eller lignende.

EN

- Read the instruction carefully before assembling the play unit.
- Assemble the components in the sequence shown in these instructions. Fixings must not be fully tightened during assembly. Before casting the foundations, the structure must be level and plumb, at which point all fixings are tightened. PS! If use of drill, the bolts may be wrecked.
- Avoid positioning the slide facing due south because of overheating – ideal positions are facing north-east or north-west. Secure the construction-area to prevent people from walking through it.
- Consider installing barriers around play-equipment which gives rise to a lot of activity – i.e. swings.
- Ensure that clear vision is possible across the play area so that supervision is possible from any position, particularly where children under 3 years of age will be playing.

NB! During assembly of the equipment, ensure that all structures are securely propped, especially when left overnight. Also ensure that equipment is supported

Monteringstips / Assembly Advice / Monteringsstips**S**

- Läs monteringsanvisningen noga före montering.

- Montera delarna i den ordningen som anvisas
- Skruvarna bör inte skruvas för hårt tills allt är monterat, i våg och lodat.

OBS! Används elektrisk skruvdragare, kan bulten gå sönder. Hårdra därför manuellt!











- Solen kan göra att rutchbanan blir väldigt varm. Banans nedfart rekommenderas att vändas i norrlig riktning
- Om lekplatsen placeras vid en gångväg mm bör området säkras mot genomfart av gående och cyklister.
- Insprängningshinder bör placeras runt lekutrustning med stor rörelse, t ex, gungställning.
- Det bör vara fri insyn till lekutrustning beräknat till barn under 3 år.

OBS! Under monteringsarbete bör utrustningen som inte ska förankras i marken, ställs så att den inte kan välta.

Området måste spärras när lekutrustningen byggs upp, med avspärrningsband eller liknande.

NO	Betongkvalitet	C25/30		
SE	Betongkvalitet			
EN	Concrete quality			
NO	Mengde betong		0,2	m ³
SE	Mängd betong			
EN	Amount of concrete			
NO	Fundament størrelse		0,5x0,5x0,4	m
SE	Stiftelsestorlek			
EN	Foundation size			
NO	For sikkerhet må fundamentene med sand eller myk jord være minst 50% større i areal			
SE	För säkerheten måste grunden med sand eller mjuk jord vara minst 50% större i området			
EN	For safety, the foundations with sand or soft soil must be at least 50% larger in area			
NO	Tyngste element	40-145-014	14,3	Kg
SE	Tyngsta element			
EN	Heaviest element			
NO	Største element	40-145-014	1 x 0,9 x 0,12	m
SE	Största element			
EN	Biggest element			

Nødvendig verktøy / Tools required / Nödvändiga verktyg

<p>(N)</p> <p>(EN)</p> <p>(S)</p>	<p>(A)</p> 	<p>(B)</p>  <p>Torx Nr 45</p>	<p>(C)</p> <p>5 mm 6 mm</p> 	<p>(D)</p> 	<p>(E)</p> 
		<p>Metermål</p> <p>Metric measure</p> <p>Tumstock</p> 	<p>Ø11mm Bor</p> <p>Ø11mm Drill</p> <p>Ø11mm Borr</p> 	<p>Merkebånd</p> <p>Mark ribbon</p> <p>Märkeband</p> 	<p>13 + 17mm</p> 

Nødvendig antall personer / Number of persons required / Rekommenderad antal personer



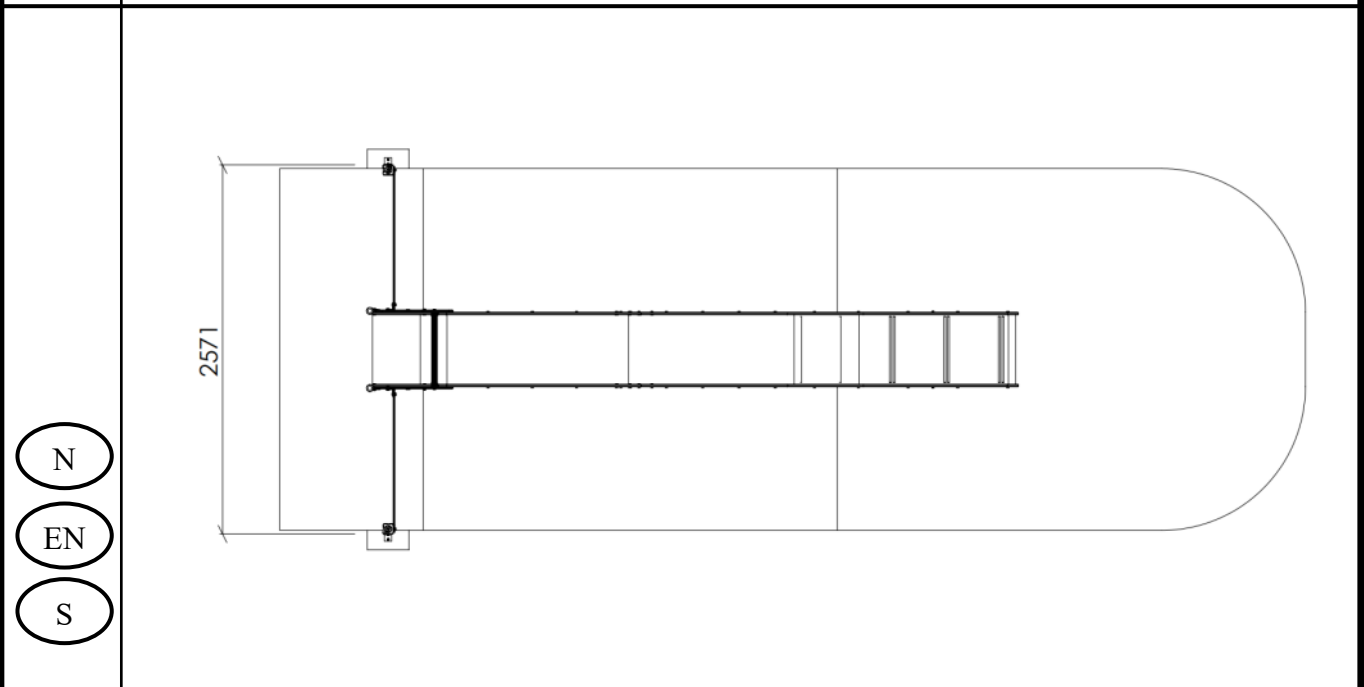

Anbefalt arealbehov ved montering / Recommended working space / Rekommenderad arealbehov vid montering

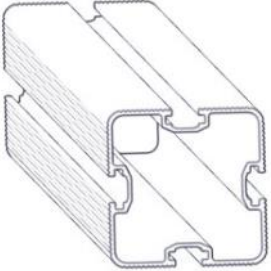
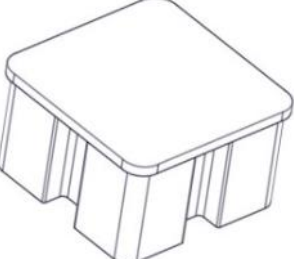

Boltepakker for / Boltpackage for / Bultpaket för

Sign. _____

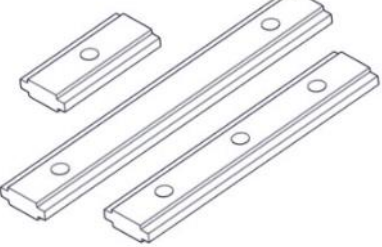
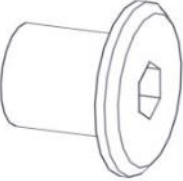
Rekkverk til plattform terrengsklie 40-145-050	Navn	Artnr/ dimensjon	Ant	Lev
	Stolpe 70x70 Lengde = 1200 (600-600) Sort	SFA5123/1	2	
	Endelukk 70x70stolpe Sort	00-400-996	2	
	Rekkverk terrenggrutsje 1029x916x12	40-145-014	2	
	Torx M8x12 Torx M8x20 Torx M8x25 Torx M8x45	04-000-012 04-000-020 04-000-025 04-000-045	4 4 6 2	
	Brikke alu	04-060-050	6	
	Møbelknapp M8x11	04-030-011	8	

Boltepakker for / Boltpackage for / Bultpaket för

Sign. _____.

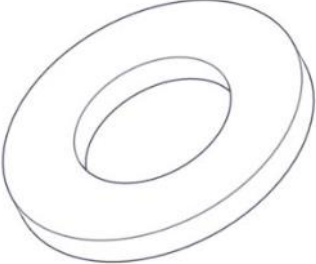
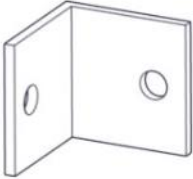
Rekkverk til plattform terrengsklie 40-145-050	Navn	Artnr/ dimensjon	Ant	Lev
	Skive M8	04-050-008	4	
	Vinkel 50x50x5	04-070-050	4	

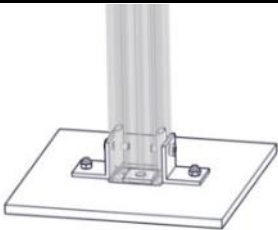
Boltepakker for / Boltpackage for / Bultpaket för		Sign. _____.		
Rekkverk til plattform terrengsklie 40-145-050	Navn	Artnr/ dimensjon	Ant	Lev
	Fundament Støp			
	Støpefundament 70x70 stolpe	00-003-112K (Se egen Delmontering)	2	
	Fundament Nedgravning			
	Nedgravningsfundament 70x70 stolpe	07-510-207K (Se egen Delmontering)	2	

Fundamentering med betong / Foundation concrete / Förankring med betong

- (N) Støtdempende materialer Ref NS-EN 1176-1
- (EN) Impact attenuating materials §4.2.8.5
- (S) Støtdämpande material



- (N) Bakkenivå
- (EN) Ground level
- (S) marknivå

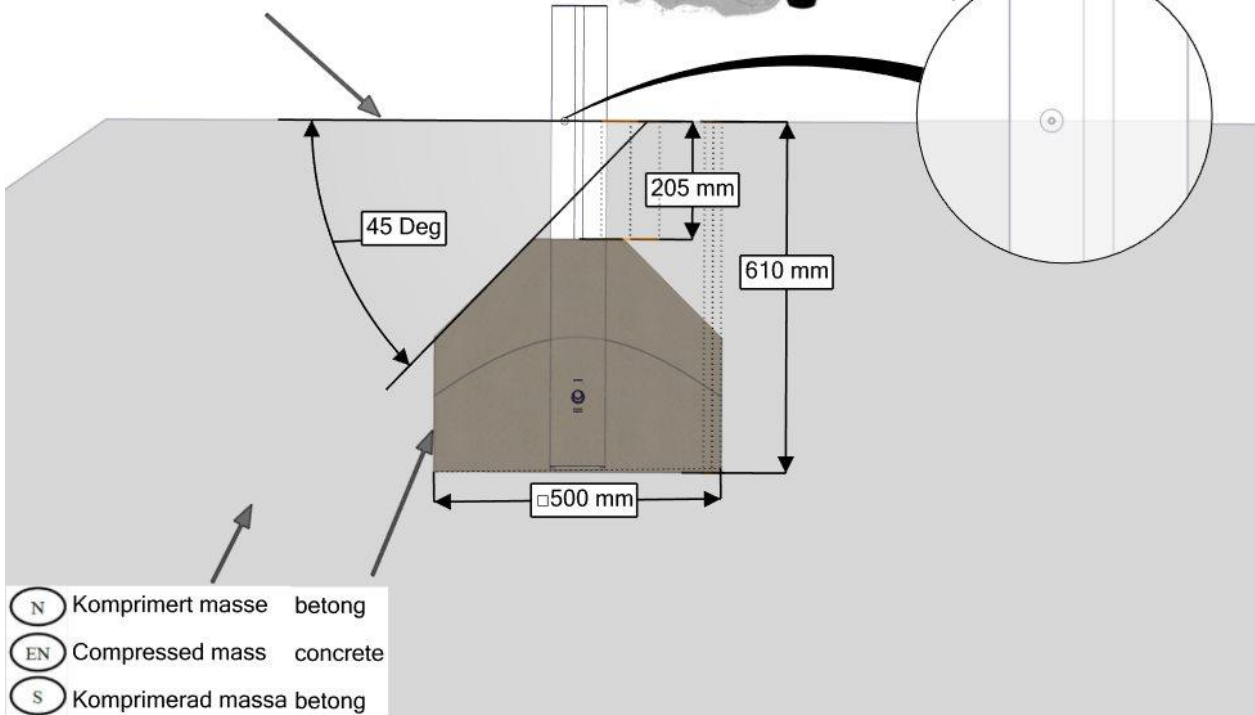

- (N) Komprimert masse betong
- (EN) Compressed mass concrete
- (S) Komprimerad massa betong

Fundamentering uten betong / Foundation without concrete / Förankring utan betong

- (N) Støtdempende materialer Ref NS-EN 1176-1
- (EN) Impact attenuating materials §4.2.8.5
- (S) Støtdämpande material

- (N) Bakkenivå
- (EN) Ground level
- (S) Marknivå

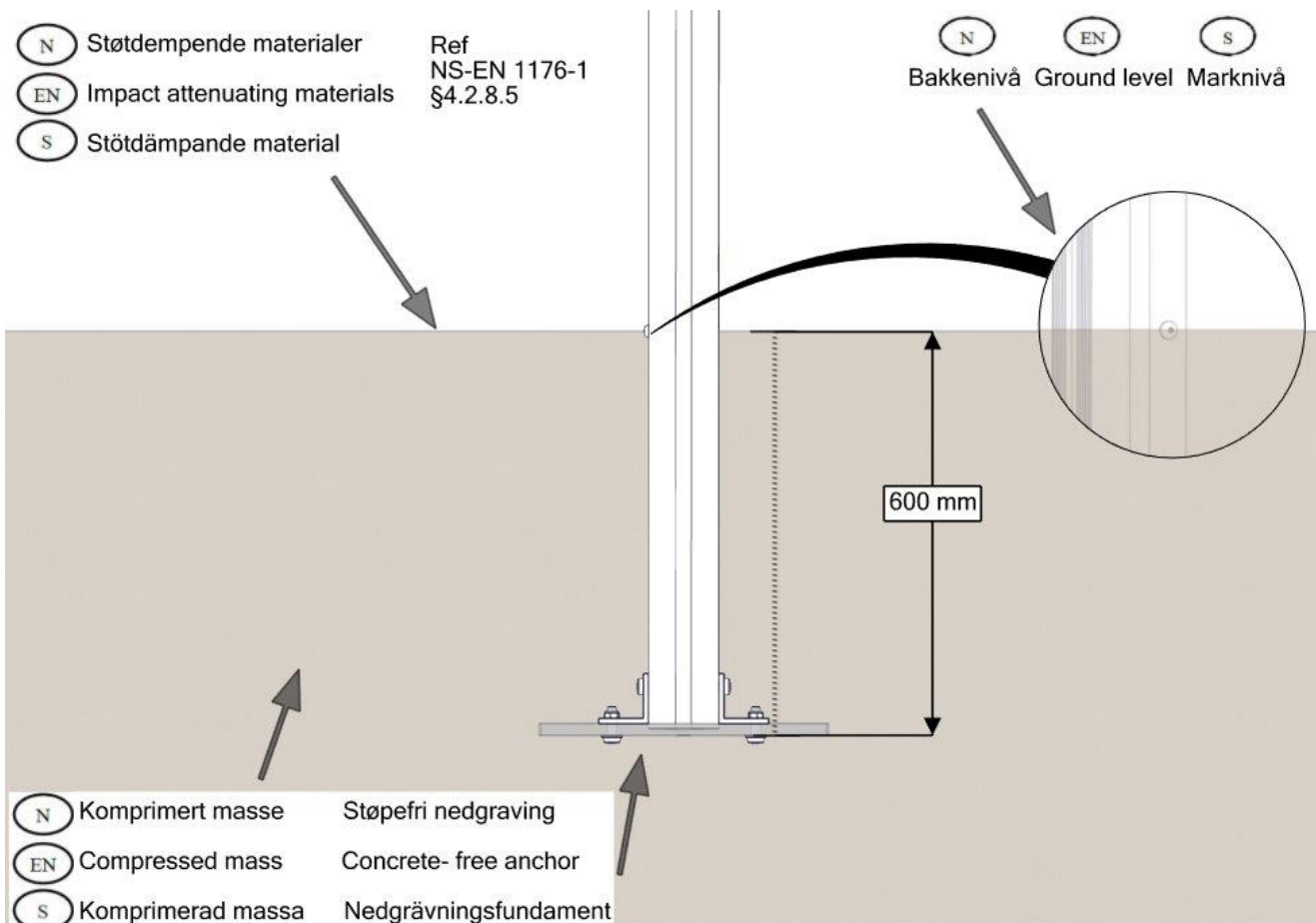

- (N) Komprimert masse Støpefri nedgraving
- (EN) Compressed mass Concrete-free anchor
- (S) Komprimerad massa Nedgravningsfundament

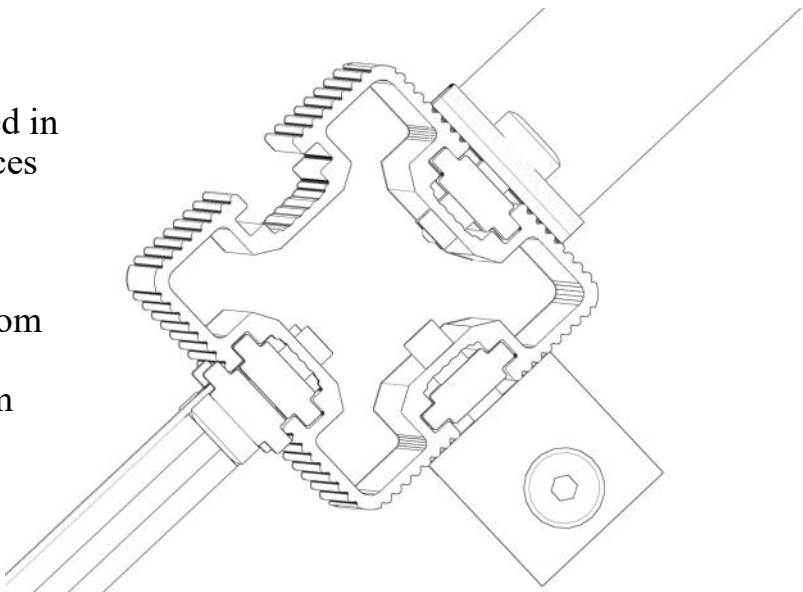
<p>N</p>	<p>Bolten skrues HELT igjennom aluminiumen. Maks moment: 30Nm</p>
<p>EN</p>	<p>The bolt must be tightened in to the post, so that it peirces the aluminium Max torque: 30Nm</p>
<p>S</p>	<p>Bulten skruvas HELT genom aluminiumen. Maks Vridmoment: 30Nm</p>
<p>N</p>	<p>Alle mål er oppgitt i millimeter</p>
<p>EN</p>	<p>Scale measured in mm</p>
<p>S</p>	<p>Alla mått är i millimeter.</p>
	

Fallhøyder / Free height of fall / Fallhöjder

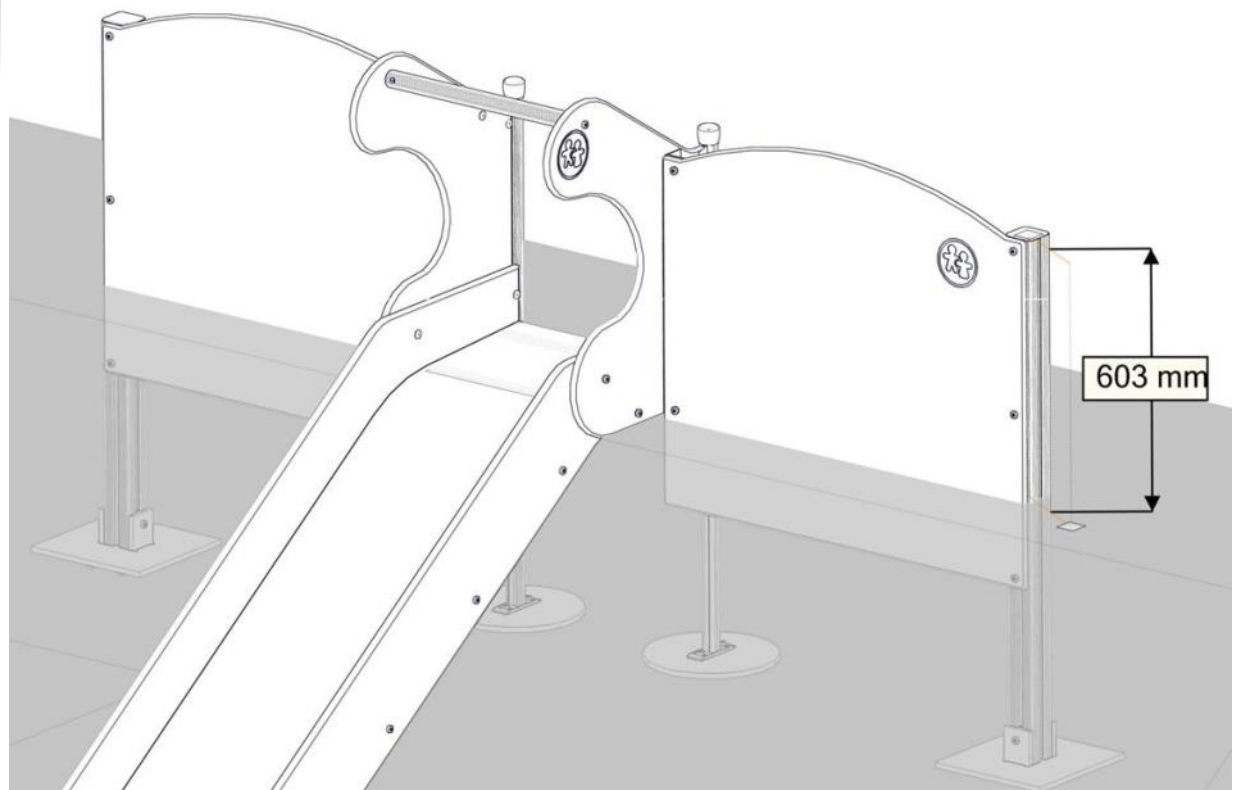

Plassering / Placement / Placering

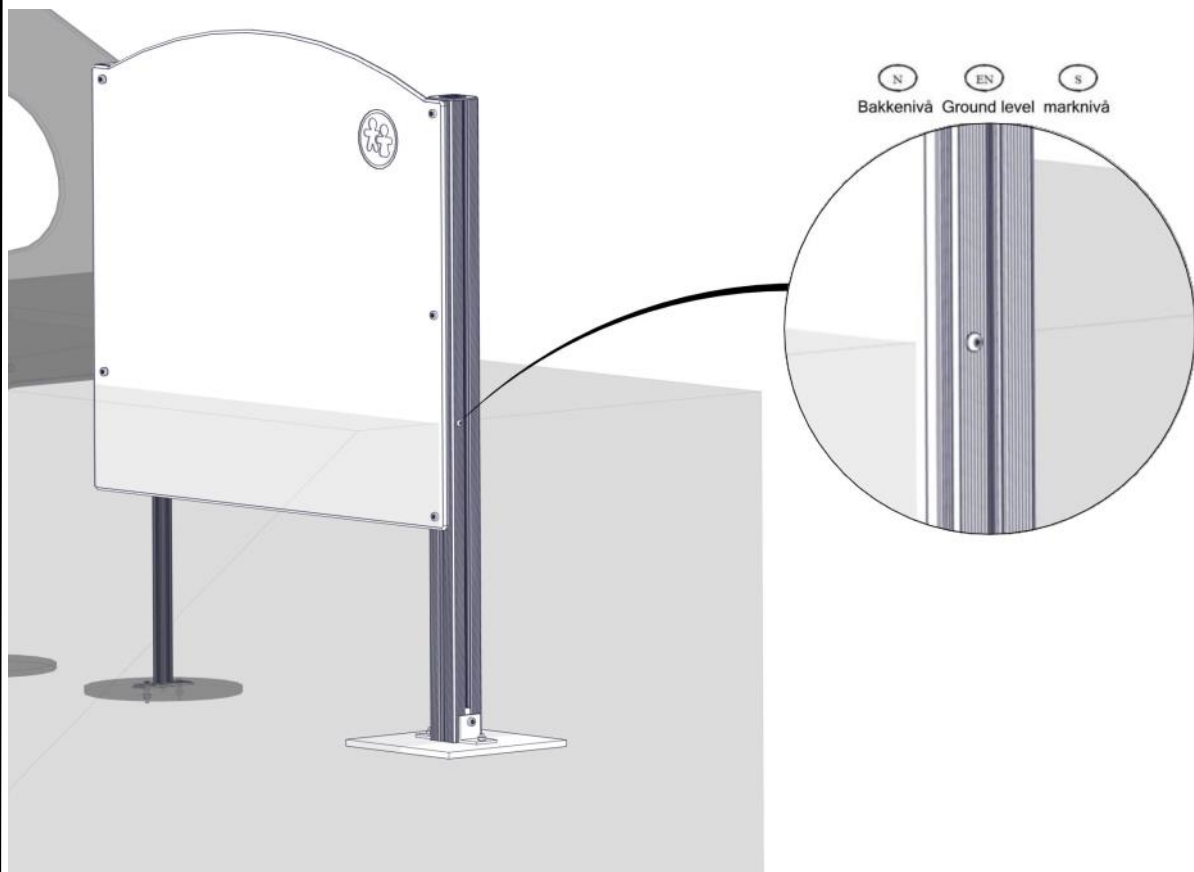

Montering av lekeapparatet / Assembly instructions / Montering av lekredskapet

Se separat delmontering for detaljer
 See separate assembly for details
 Se separata delmontering för detaljer

x2

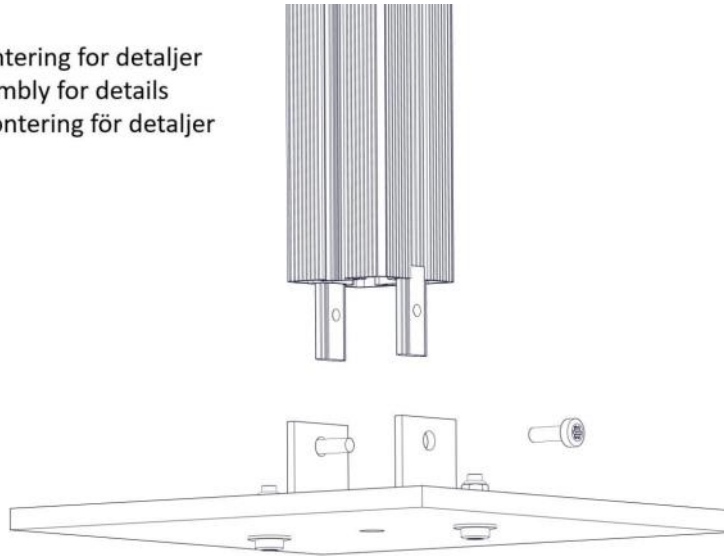

Name	Artnr (config)	Qty
Fun_VK70V2	07-510-207K	1
VK70_SFA5123_miniserie	SFA5123/1	1

Ikke stram boltene

x2

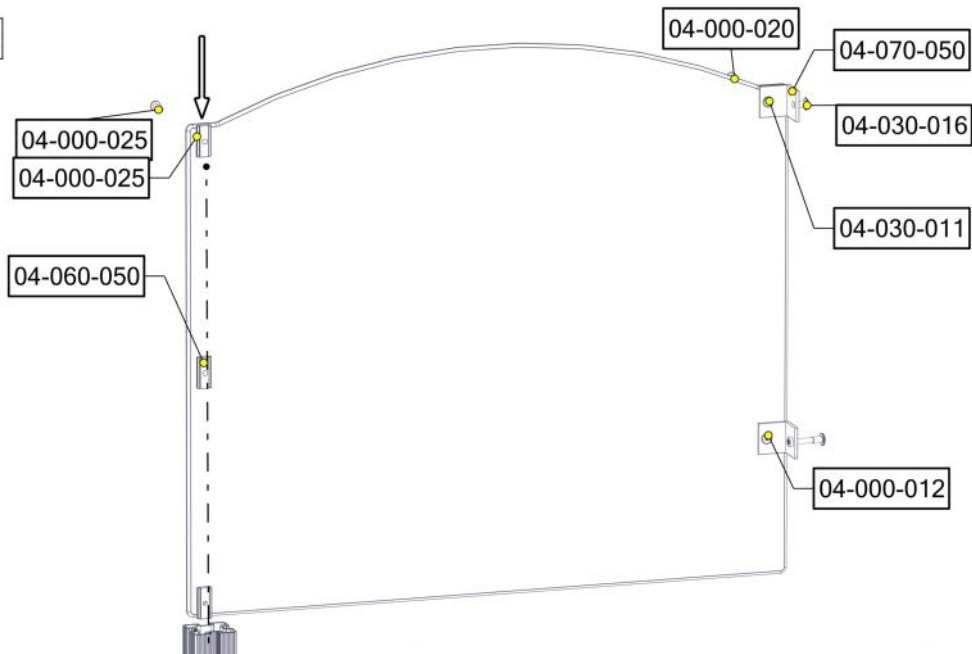

Name	Artnr (config)	Qty
50x50x5	04-070-050	2
brikke_SFA5116	04-060-050	3
Mobelknapp	04-030-01	4
Skive	04-050-008	2
TorxM8	04-000-025	3

Name	Artnr (config)	Qty
TorxM8	04-000-0	2
TorxM8	04-000-012	1
TorxM8	04-000-012	1

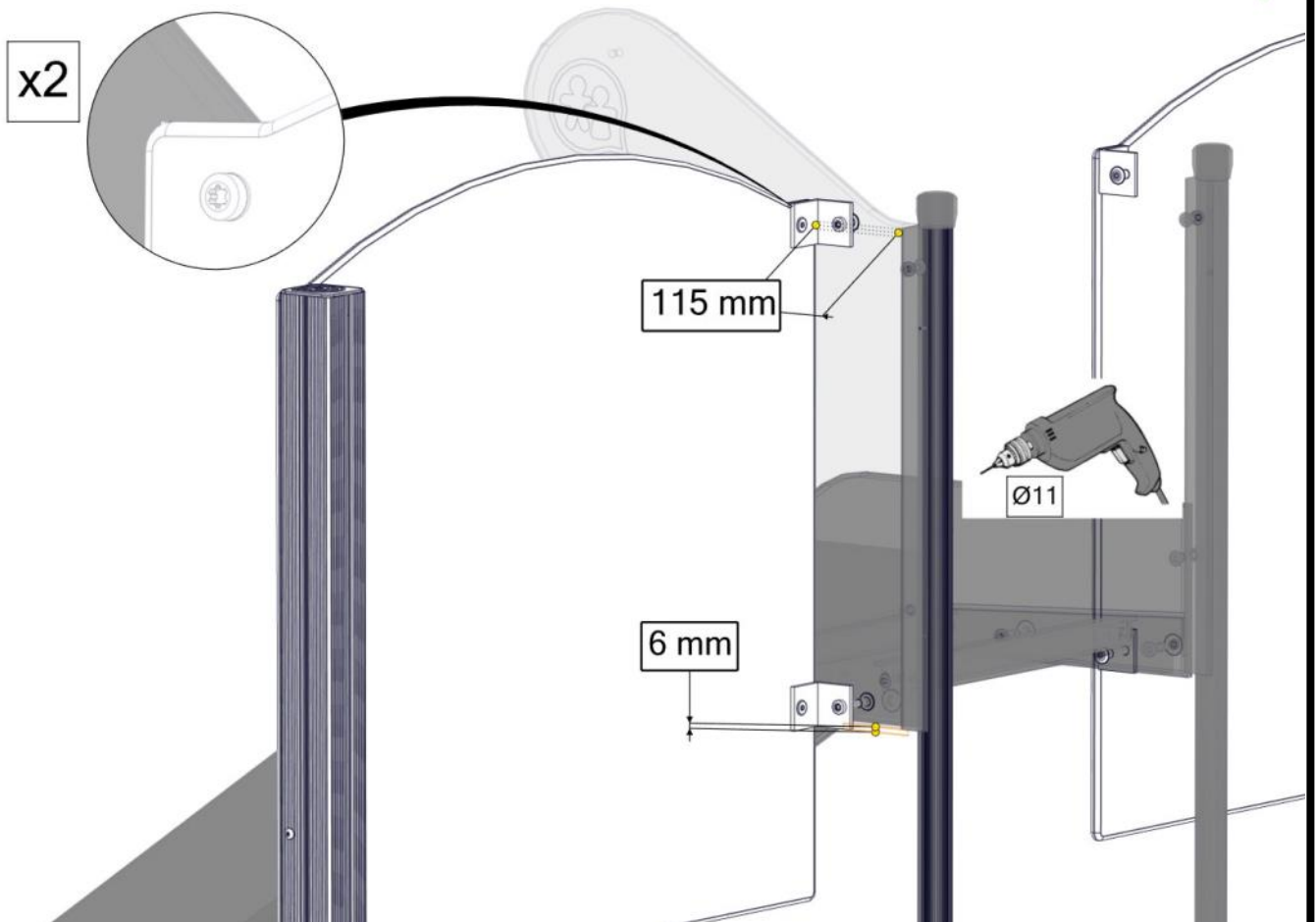
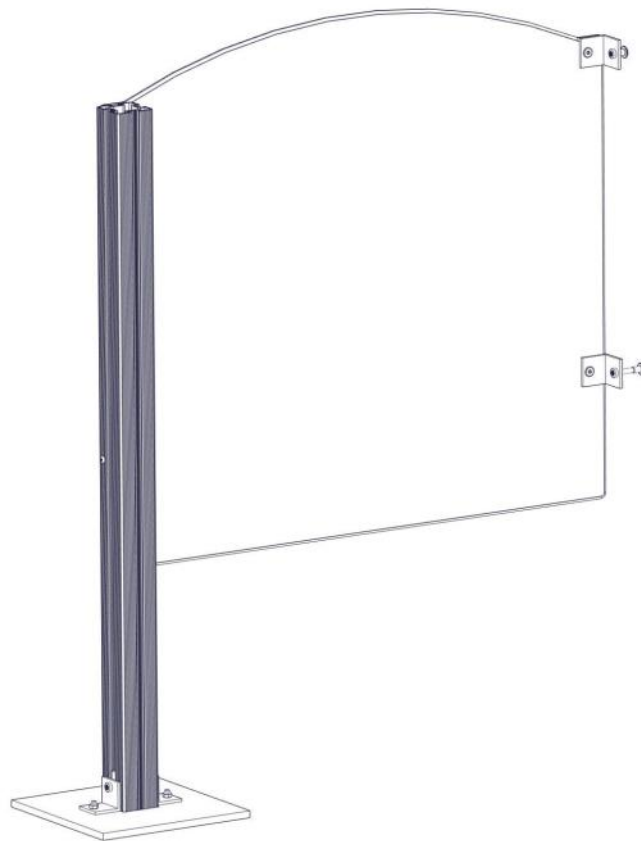

Montering av lekeapparatet / Assembly instructions / Montering av lekredskapet

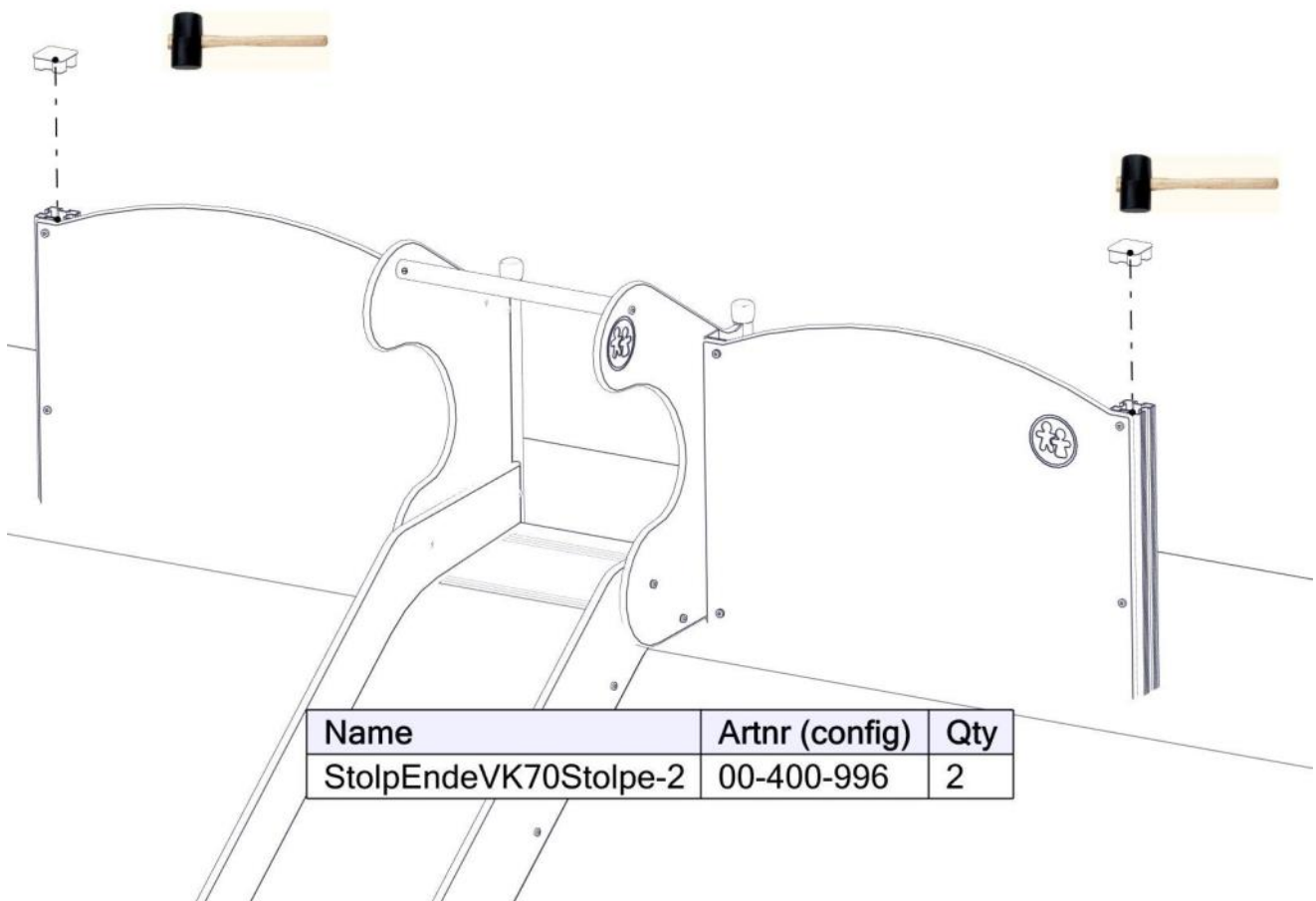
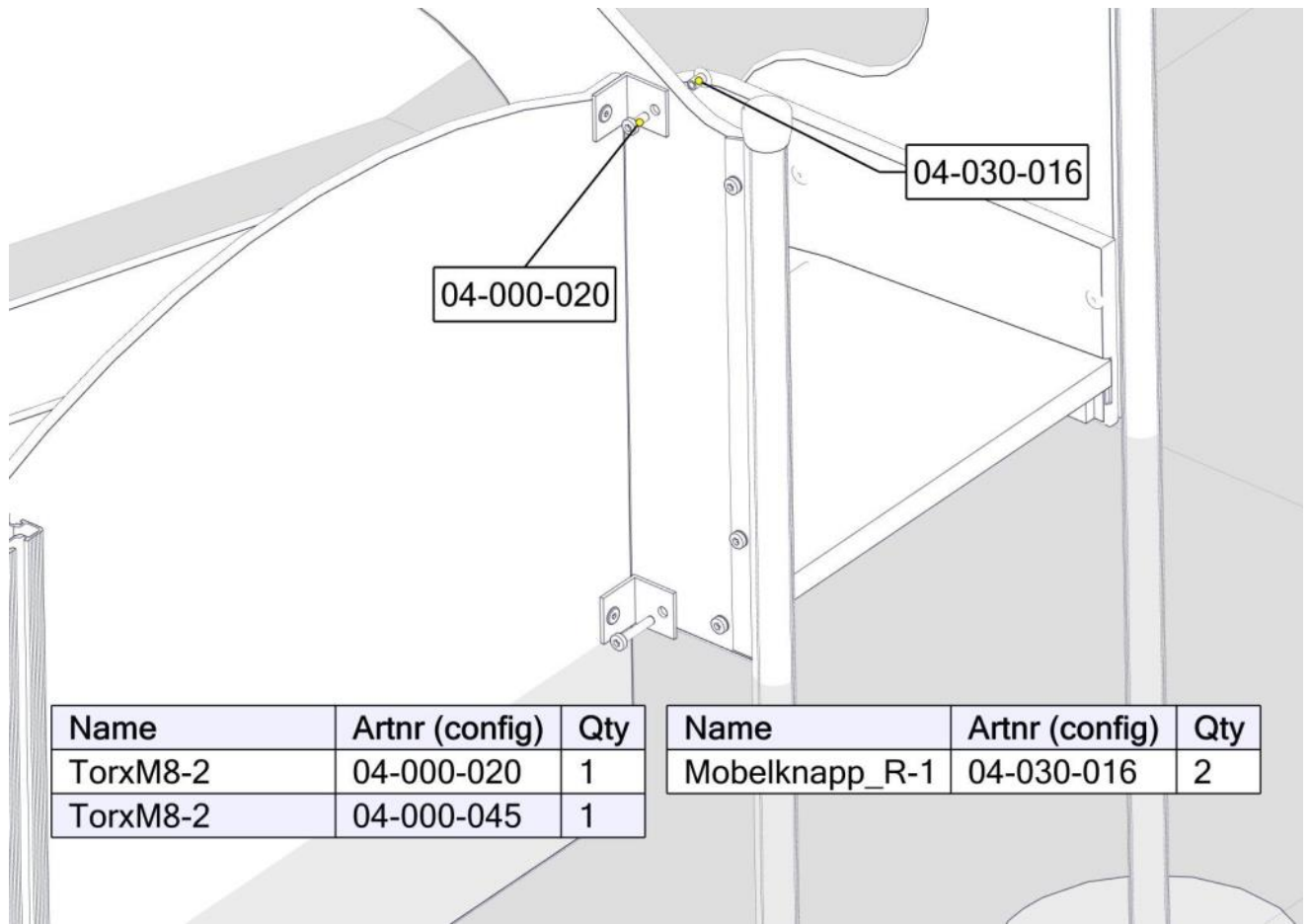
Montering av lekeapparatet / Assembly instructions / Montering av lekredskapet

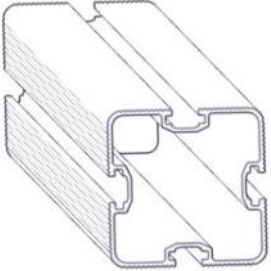
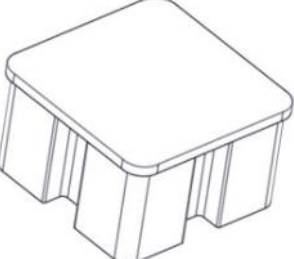

Boltepakker for / Boltpackage for / Bultpaket för

Sign. _____

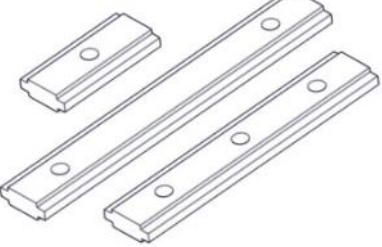
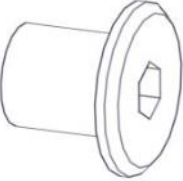
Rekkverk til plattform terrengsklie 40-145-050	Navn	Artnr/ dimensjon	Ant	Lev
	Stolpe 70x70 Lengde = 1200 (600-600) Sort	SFA5123/1	2	
	Endelukk 70x70stolpe Sort	00-400-996	2	
	Rekkverk terrenggrutsje 1029x916x12	40-145-014	2	
	Torx M8x12 Torx M8x20 Torx M8x25 Torx M8x45	04-000-012 04-000-020 04-000-025 04-000-045	4 4 6 2	
	Brikke alu	04-060-050	6	
	Møbelknapp M8x11	04-030-011	8	

Boltepakker for / Boltpackage for / Bultpaket för

Sign. _____.

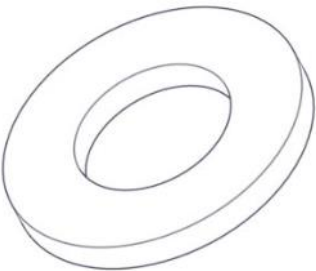
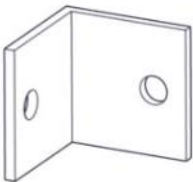
Rekkverk til plattform terrengsklie 40-145-050	Navn	Artnr/ dimensjon	Ant	Lev
	Skive M8	04-050-008	4	
	Vinkel 50x50x5	04-070-050	4	

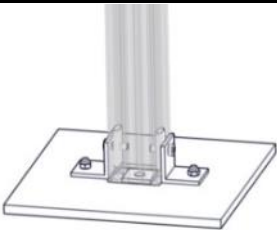
Boltepakker for / Boltpackage for / Bultpaket för		Sign. _____.		
Rekkverk til plattform terrengsklie 40-145-050	Navn	Artnr/ dimensjon	Ant	Lev
	Fundament Støp			
	Støpefundament 70x70 stolpe	00-003-112K (Se egen Delmontering)	2	
	Fundament Nedgravning			
	Nedgravningsfundament 70x70 stolpe	07-510-207K (Se egen Delmontering)	2	

Oppdatert fundament, og hele monteringsanvisning
21-11-2022
MNO