

**(N) Monteringsanvisning**

**(UK) Assembly Instructions**

**(S) Monteringsanvisning**

Produkt nr. / Product no. / Produkt nr.

**60-162-305**

Ordr. nr. \_\_\_\_\_

Dato. \_\_\_\_\_

Sign. \_\_\_\_\_

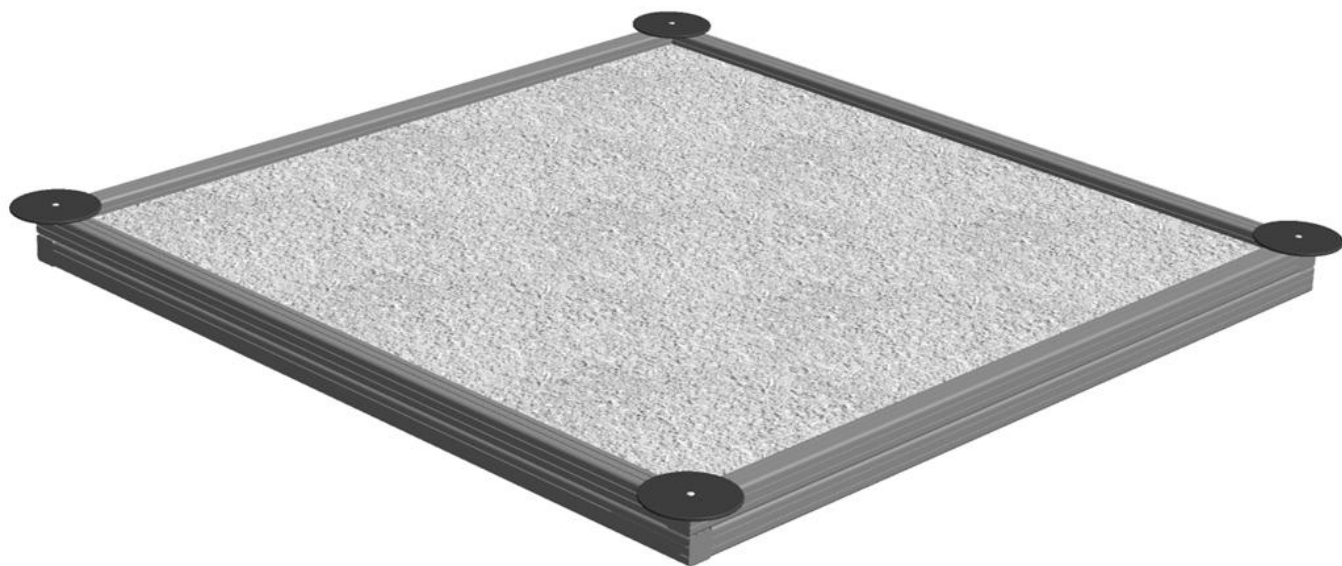

## Søve Fabrikker AS

3830 Ulefoss - Norway  
Tlf: +47 35 94 65 65  
[www.sove.no](http://www.sove.no)



## Søve AB

412 50 Göteborg  
Phone: +46 (0)31 773 97 00  
[www.sove.se](http://www.sove.se)

19.11.2010

2

Nødvendig verktøy / Tools required / Nödvändiga verktyg



N  
UK  
S

3

Nødvendig antall personer / Number of persons required / Lämpligt antal personer



N  
UK  
S

4

Anbefalt arealbehov ved montering / Recommended working space / Rekommenderad arealbehov vid montering

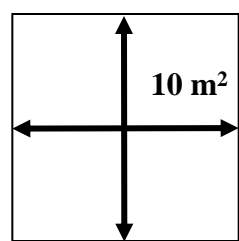

N  
UK  
S

7

**Sikkerhetssone / Safety zone / Säkerhetszon**

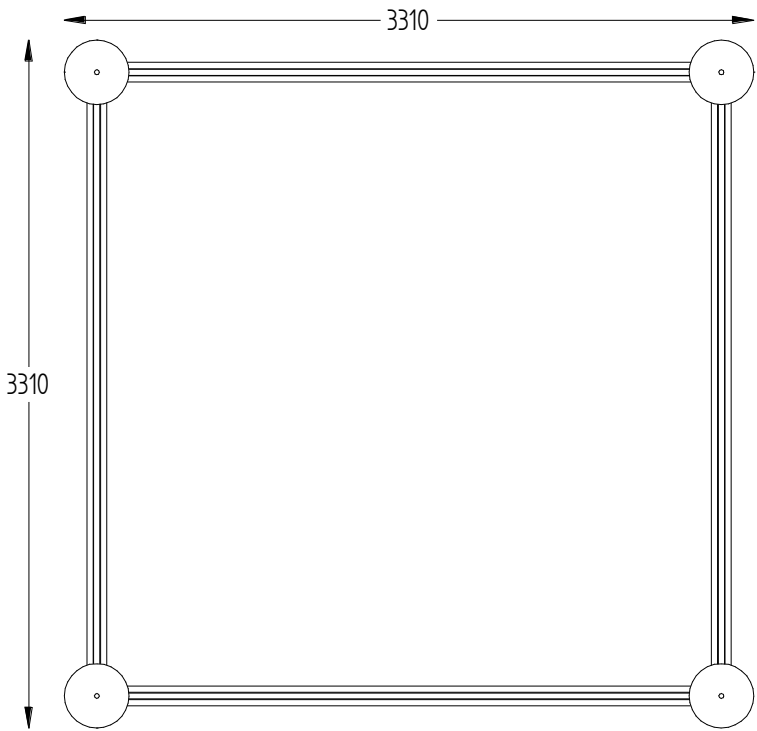

- (N) Alle mål er oppgitt i millimeter
- (UK) Scale measured in mm
- (S) Alla mått är i millimeter

8

**Fallhøyder / Free height of fall / Fallhöjder**

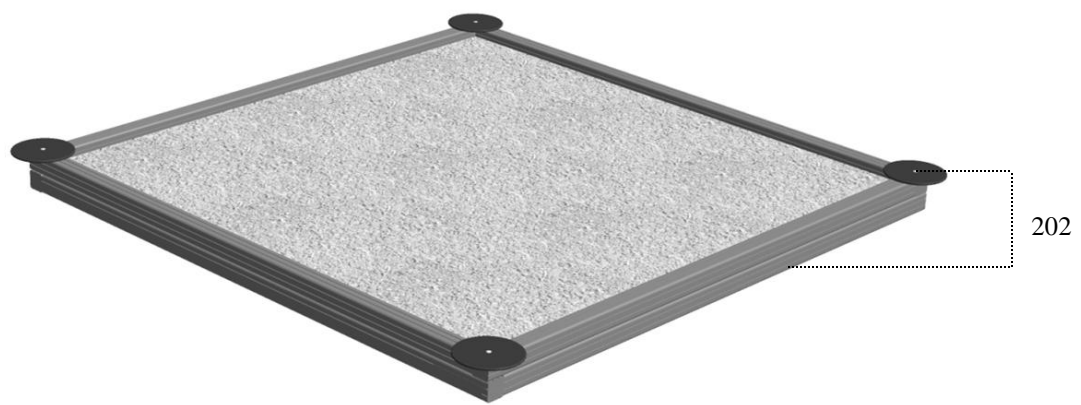

- (N) Alle mål er oppgitt i millimeter
- (UK) Scale measured in mm
- (S) Alla mått är i millimeter.



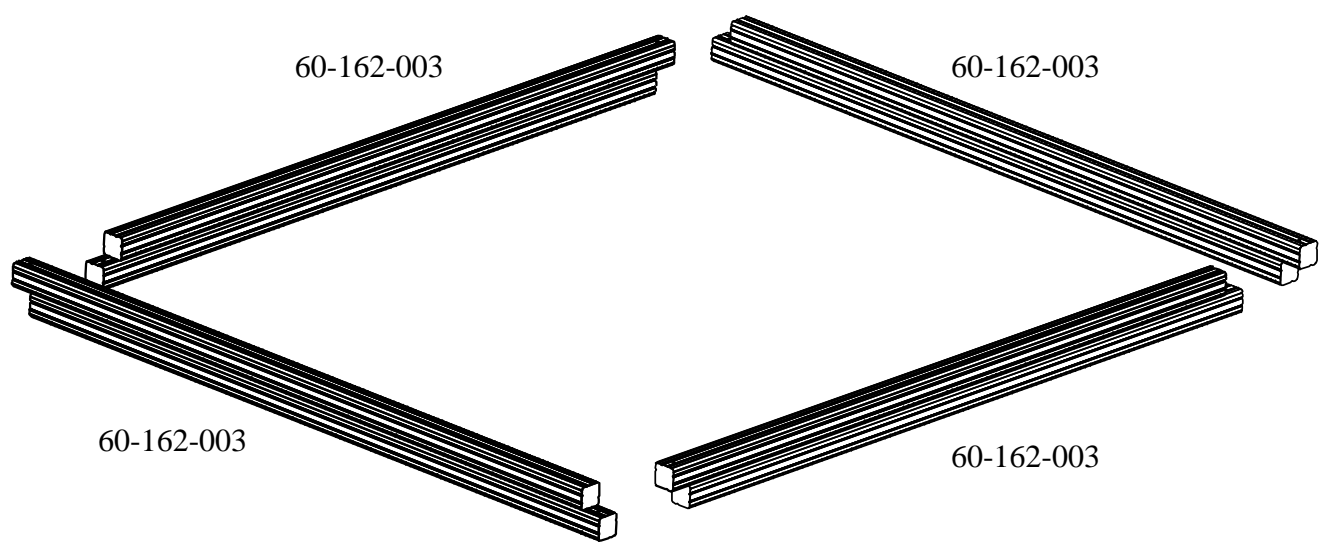

1

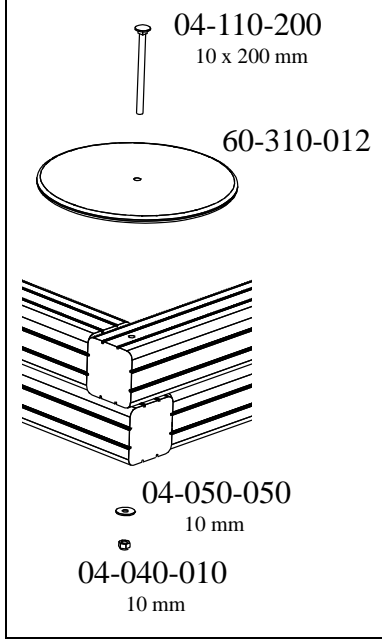
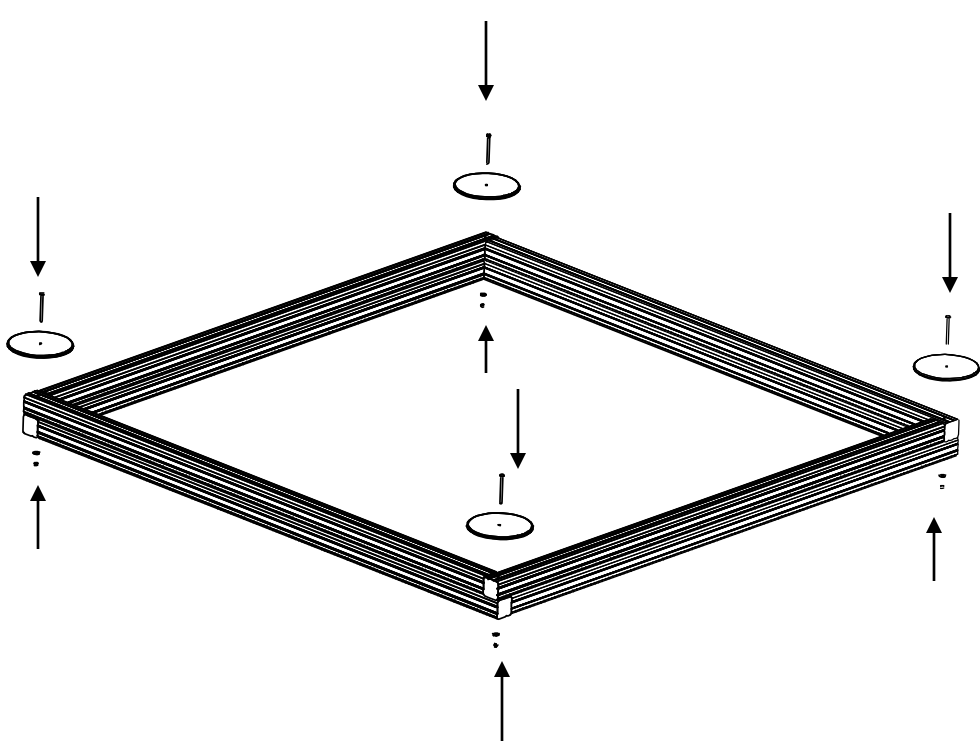

2

