

N**Monteringsanvisning****EN****Assembly Instructions****S****Monteringsanvisning**

Produkt nr. / Product no. / Produkt nr.

Styrhus Skute

Ord. nr. _____

Dato. _____

Sign. _____

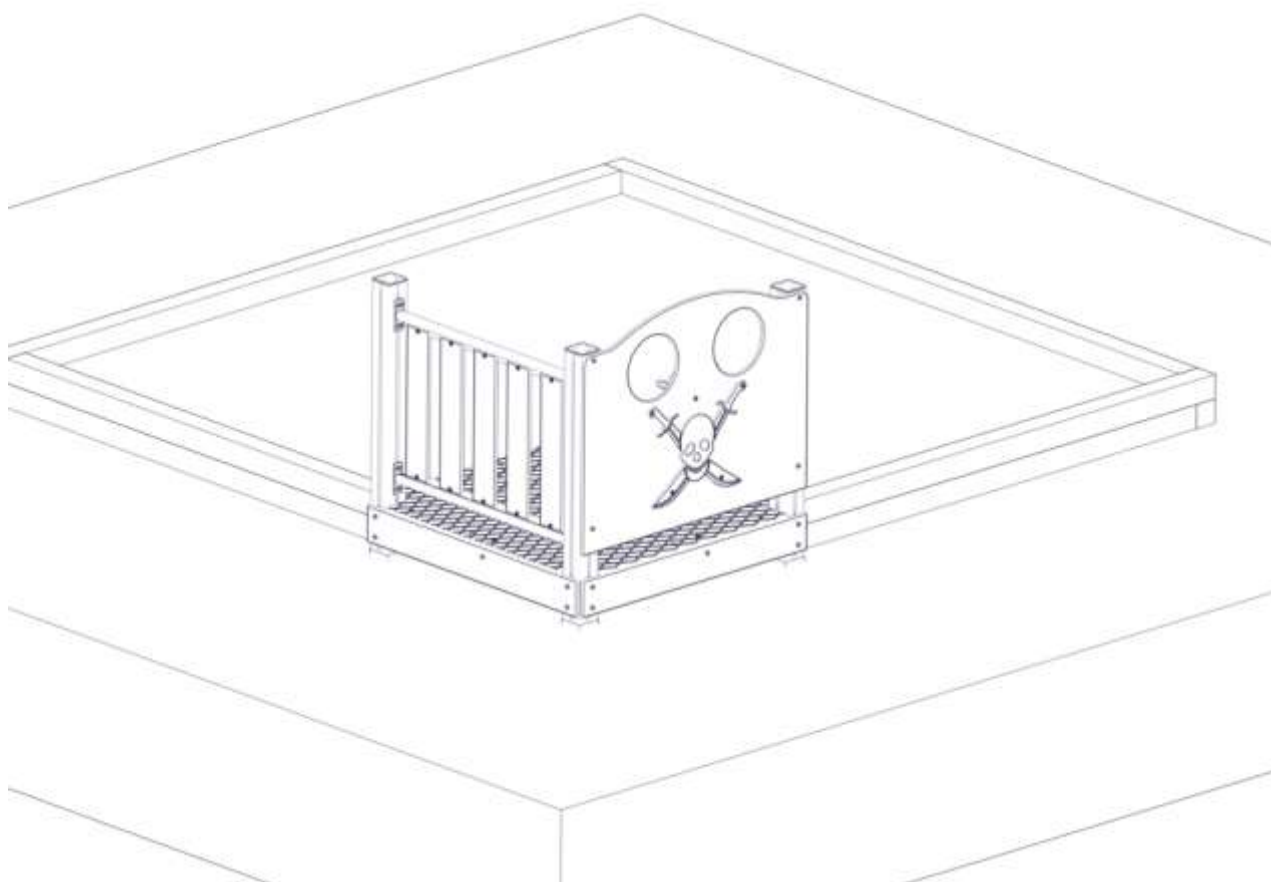
**søve**

Søve AS
3830 Ulefoss - Norway
Tlf: +47 35 94 65 65
www.sove.no



Søve AB
EA Rosengrens-gatan 32
421 31 Västra Frölunda
Phone: +46 (0)31 773 97 00
www.sove.se

Monteringstips / Assembly Advice / Monteringsstips

N

- Les monteringsanvisningen nøye før montering.
- Monter elementene i rekkefølgen som vist.
- Boltene bør ikke skrues for hardt til før alt er montert, vatret og loddet. Skru så boltene til.
- NB! Ved bruk av drill, kan boltene ryke.
- På grunn av at solen kan gjøre rutsjeplatene veldig varme, bør rutsjebanens utløp vende mot nord-øst eller nord-vest.
- Er lekeutstyret plassert i naturlige ferdselstraséer må området sikres mot gjennomgang.
- Innspringningshinder bør vurderes rundt lekeapparater hvor det er stor bevegelse, f.eks. ved huskestativ.
- Det bør være fritt innsyn til lekeutstyr som er beregnet for barn under 3 år.

NB! Under monteringsarbeidet må utstyr, som ikke er forankret forsvarlig i bakken, sikres slik at det ikke velte.

Området må avstenges under montering av apparatene med sperrebånd eller lignende.

EN

- Read the instruction carefully before assembling the play unit..
- Assemble the components in the sequence shown in these instructions.
- Fixings must not be fully tightened during assembly. Before casting the foundations, the structure must be level and plumb, at which point all fixings are tightened.
- PS! If use of drill, the bolts may be wrecked.
- Avoid positioning the slide facing due south because of overheating – ideal positions are facing north-east or north-west.
- Secure the construction-area to prevent people from walking through it.
- Consider installing barriers around play-equipment which gives rise to a lot of activity – i.e. swings.
- Ensure that clear vision is possible across the play area so that supervision is possible from any position, particularly where children under 3 years of age will be playing.

NB! During assembly of the equipment, ensure that all structures are securely propped, especially when left overnight. Also ensure that equipment is supported whilst concrete foundations are setting and enclose the area securely to prevent access.

Monteringstips / Assembly Advice / Monteringsstips

S

- Läs monteringsanvisningen noga före montering.
- Montera delarna i den ordningen som anvisas
- Skruvarna bör inte skruvas för hårt tills allt är monterat, i våg och lodat.











OBS! Används elektrisk skruvdragare, kan bulten gå sönder. Hårdra därför manuellt!

- Solen kan göra att rutchbanan blir väldigt varm. Banans nedfart rekommenderas att vändas i norrlig riktning
- Om lekplatsen placeras vid en gångväg mm bör området säkras mot genomfart av gående och cyklister.
- Inspringningshinder bör placeras runt lekutrustning med stor rörelse, t ex, gungställning.
- Det bör vara fri insyn till lekutrustning beräknat till barn under 3 år.

OBS! Under monteringsarbete bör utrustningen som inte ska förankras i marken, ställs så att den inte kan välta.

Området måste spärras när lekutrustningen byggs upp, med avspärrningsband eller liknande.

Nødvendig verktøy / Tools required / Nödvändiga verktyg

<p>(N)</p> <p>(EN)</p> <p>(S)</p>	<p>(A)</p> 	<p>(B)</p>  <p>Torx Nr 45 High quality</p>	<p>(C)</p> <p>5 mm 6 mm</p> 	<p>(D)</p> 	<p>(E)</p> 
		<p>Metermål Metric measure Tumstock</p> 	<p>16 V</p> 	<p>Merkebånd Mark ribbon Märkeband</p> 	<p>13 + 17mm</p> 

Nødvendig antall personer / Number of persons required / Rekommenderad antal personer





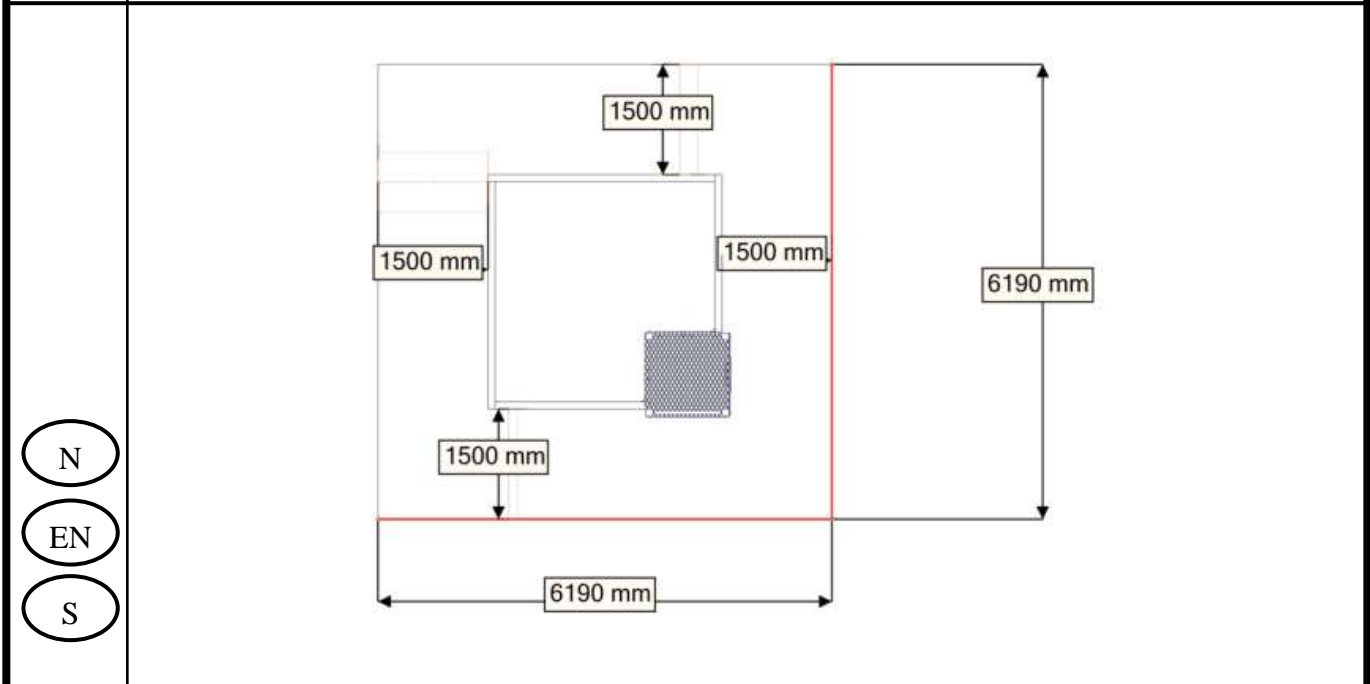









Anbefalt arealbehov ved montering / Recommended working space / Rekommenderad arealbehov vid montering























Boltepakker for / Boltpackage for / Bultpaket för

Sign. _____

Stolpe 70x70	Ant= 4	Navn	Artnr/dimensjon	Ant	Lev
		VK95 800 600-200 (1)	800	1	
		VK95 1650 600-1050	1650	3	
		Stolp ende (1)	00-400-996	4	
Skute vegge med Styr og hode	Ant= 1	Navn	Artnr/dimensjon	Ant	Lev
		Skute02-500-071(1)	02-500-0090 Med styr og hode	1	
		Torx M8x35(4)	04-000-035	4	
		Brikke 50_1T	04-060-050	4	
Rekkverk Skute	Ant= 1	Navn	Artnr/dimensjon	Ant	Lev
		Sprosse rekkverk (5)	01-400-256	5	
		Sperrerør med leppe (2)	01-400-254	2	
		Torx M8x16 (10) Torx M8x25 (8)	04-000-016 04-000-025	10 8	
		Skive M8 (10)	04-050-008	10	
		Møbelknapp (10) M8x13x17	04-030-011	10	
		Brikke 120_3T (4)	04-060-120	4	





Boltepakker for / Boltpackage for / Bultpaket för

Sign. _____

Gulv 1160x1160x15	Ant= 1	Navn	Artnr/dimensjon	Ant	Lev
		Gulv (1)	00-400-300	1	
		Vinkel 50x50x4(4) 11mm hull	04-070-050	4	
		Torx M8x30 (4) Torx M8x12(4)	04-000-030 04-000-012	4 4	
		Møbelknapp (4)	04-030-011	4	
		Låsemutter M8	04-040-008	4	
		Plast plug 9-11 mm (16)	04-090-002	16	
		Plug spor (8)	00-400-980	8	
		Skive M8 (8)	04-050-008	8	
Sprosse 01-400-108	Ant= 2	Navn	Artnr/dimensjon	Ant	Lev
		Sprosse (1) 1160x145x15	01-400-108	2	
		Torx M8x35 (4)	04-000-035	8	
		Brikke 150 _3T (2)	04-060-150	4	
prosse 01-400-115	Ant= 2	Navn	Artnr/dimensjon	Ant	Lev
		Sprosse (1) 940x145x15 Kappet sprosse 1160 til 940 på 1 side	01-400-115	2	
		Torx M8x35 (2)	04-000-035	4	
		Brikke 150 _3T (1)	04-060-150	2	
		Vinkel50x50x5 11mm hull	07-070-050	2	
		Skive M8	04-050-008	2	
		Låsemutter M8	04-040-008	2	
		Sekskant Treskru 5,5x35	04-128-035	2	

Boltepakker for / Boltpackage for / Bultpaket för

Sign. _____.

Fundament	Ant= 4	Navn	Artnr/dimensjon	Ant	Lev
		Fundament plate(1)	00-003-010	4	
		Fundamentdel1 (1) 4x med VK70 hull 1x med VK95 hull	00-003-010	4	
		Fundament del2 (1) 4x med VK70 hull 1x med VK95 hull	00-003-010	4	
		Torx M8x35(3)	04-000-035	12	
		Brikke 120 3T (1) Brikke 501T(1)	04-060-120 04-060-050	4 4	

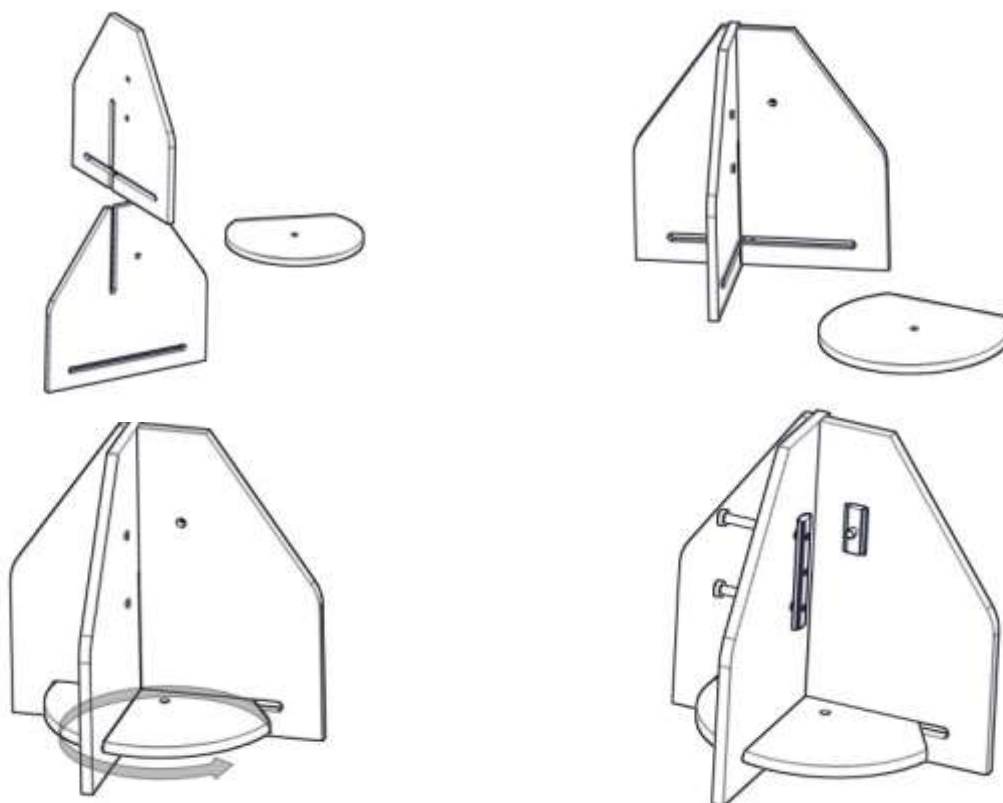

N Bolten skrues HELT igjennom aluminiumen.

EN The bolt must be tightened in to the post, so that it pierces the aluminium

S Bulten skruvas HELT ignom aluminiumen.

Fundamentering uten betong / Foundation without concrete / Förankring utan betong

N Støtsand

EN Safer surface

S Stridsan

N Komprimert masse

EN Compressed mass

S Komprimerad massa

N Alle mål er oppgitt i millimeter

EN Scale measured in mm

S Alla mått är i millimeter.

N Bakkenivå

UK Ground level

S Marknivå

Ref NS-EN 1177

642 mm

Støpefri nedgraving

Concrete-free anchor

Nedgravningsfundament

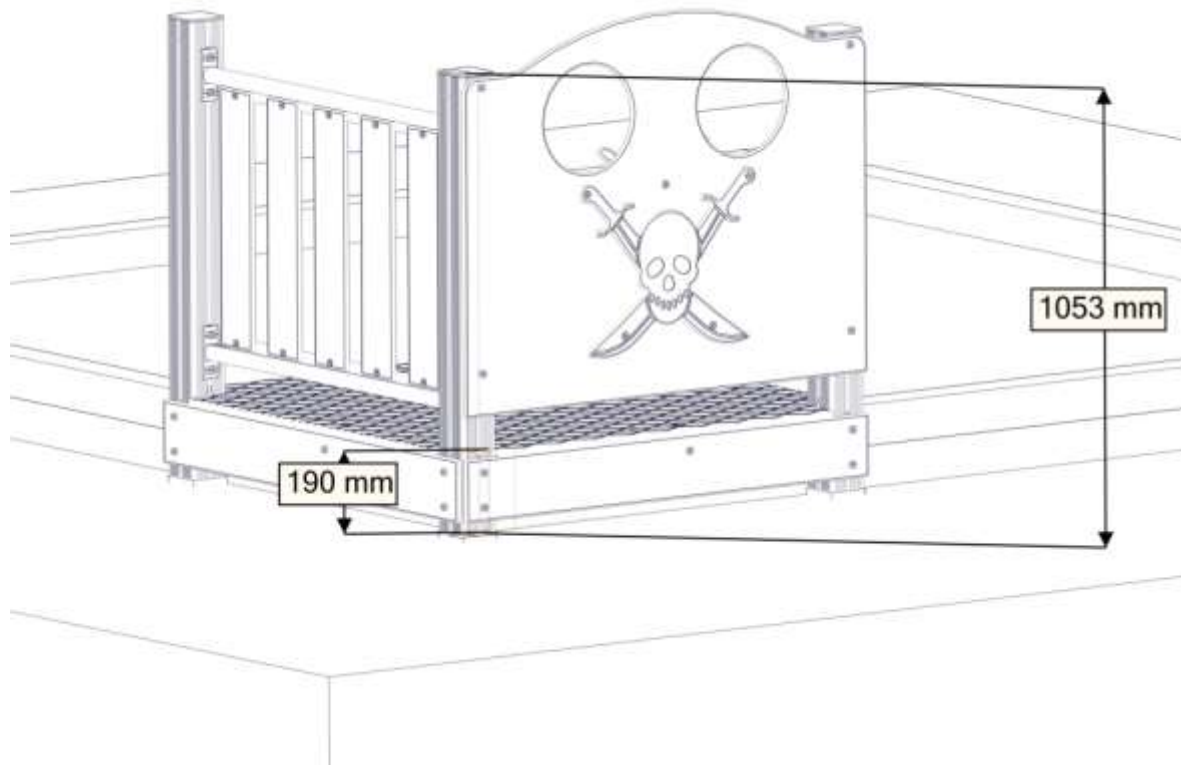
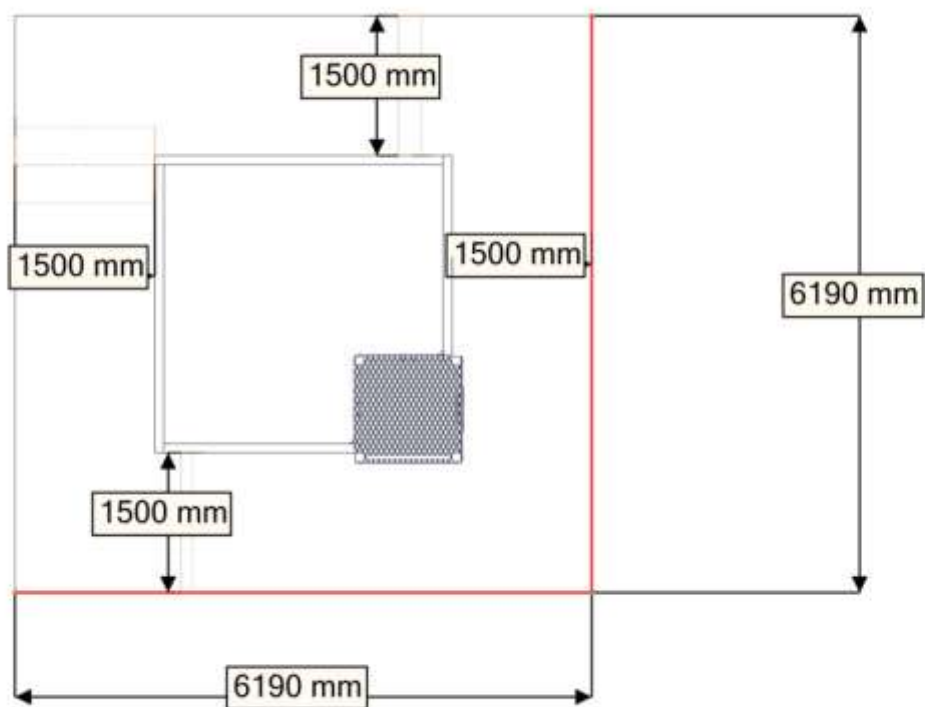
Fallhøyder / Free height of fall / Fallhöjder**Sikkerhetszone / Safety zone / Säkerhetszon**

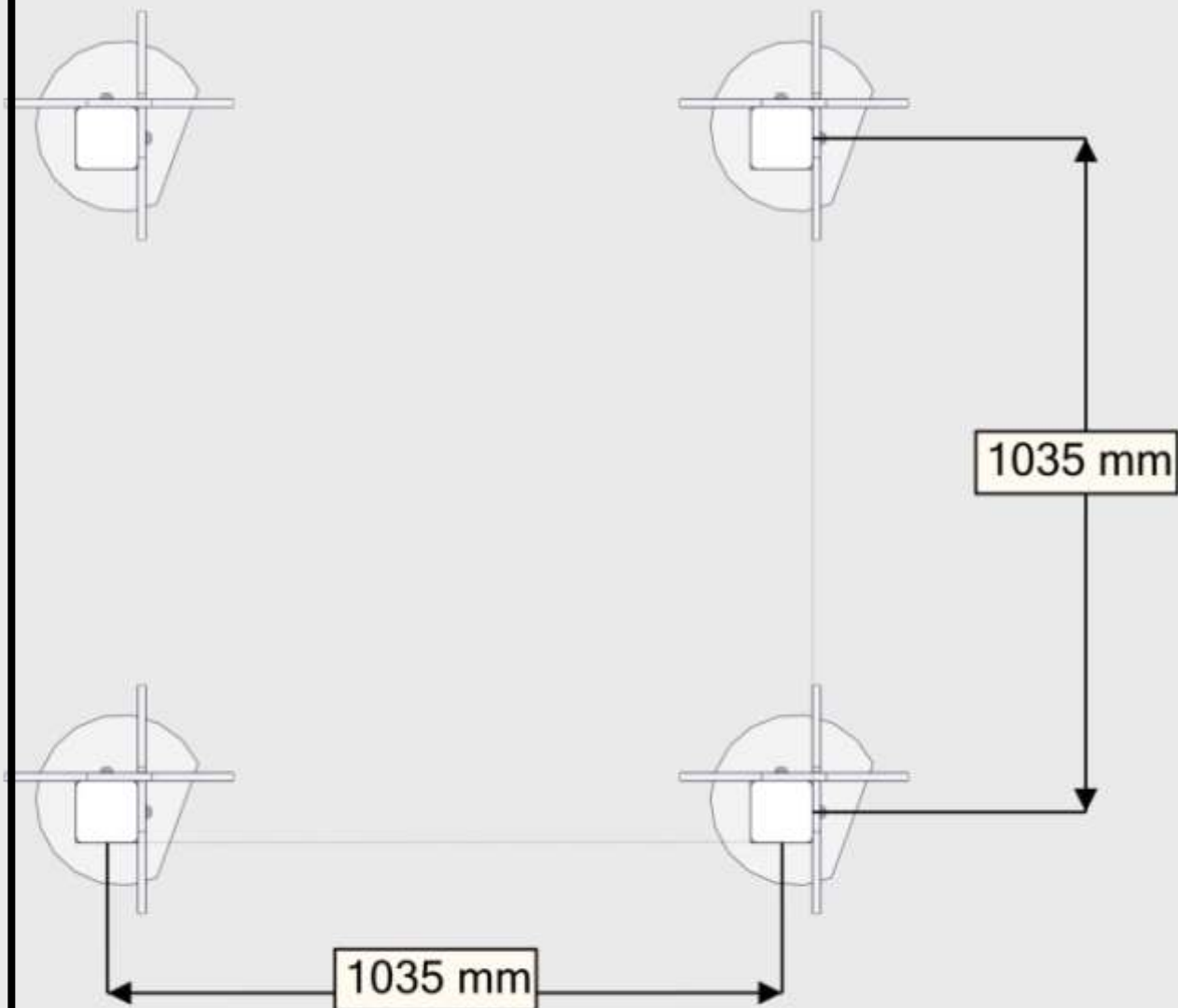
Plassering av forankringer / Ground plan / Placering av förankringar

N

Alle mål er oppgitt i millimeter

UK

Scale measured in mm

S

Alla mått är i millimeter.

Montering av lekeapparatet / Assembly instructions / Montering av lekredskapet

4x



nr	PartName	Artnr	Antall
1	Fundament spor ned	00-003-100	1
2	Fundament spor opp	00-003-101	1
3	Fundament skive	00-003-102	1
4	Torx M8x35	04-000-035	3

nr	PartName	Artnr	Antall
5	Skive M8 stor	04-055-008	3
6	Brikke50 1XM8	04-060-050	1
7	Brikke 120 3xM8	04-060-120	1

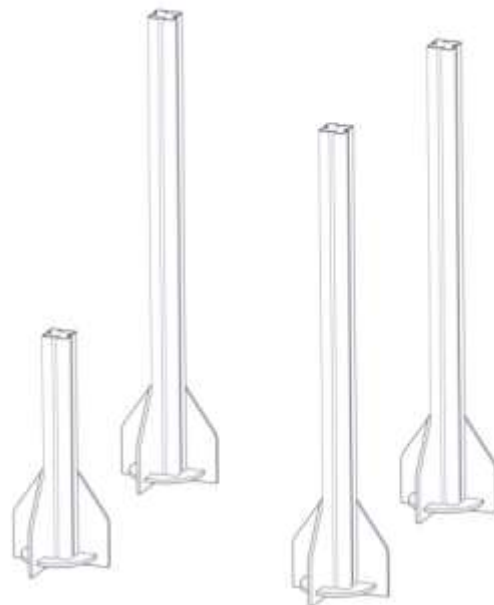

nr	PartName	Artnr	Antall
2	95x95 600-200	800	1
1	95x95 600-1050	1650	3

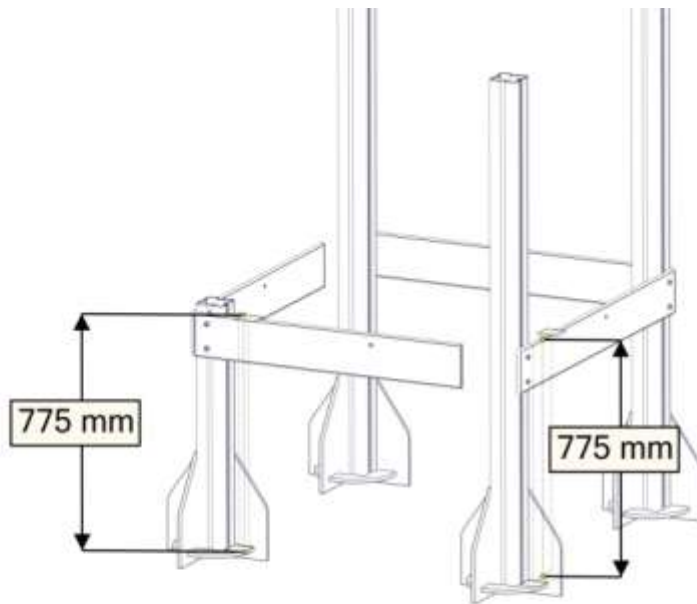

nr	PartName	Artnr	Antall
1	Sprosse 1130x145x15 1hull-574	01-400-108	2
2	Sprosse_sjoroversandkasse Høyre L=940	01-400-115	1
3	Sprosse_sjoroversandkasse Venstre L=940	01-400-116	1
4	Torx M8x35	04-000-035	12
6	Brikke 150 3xM8	04-060-150	6

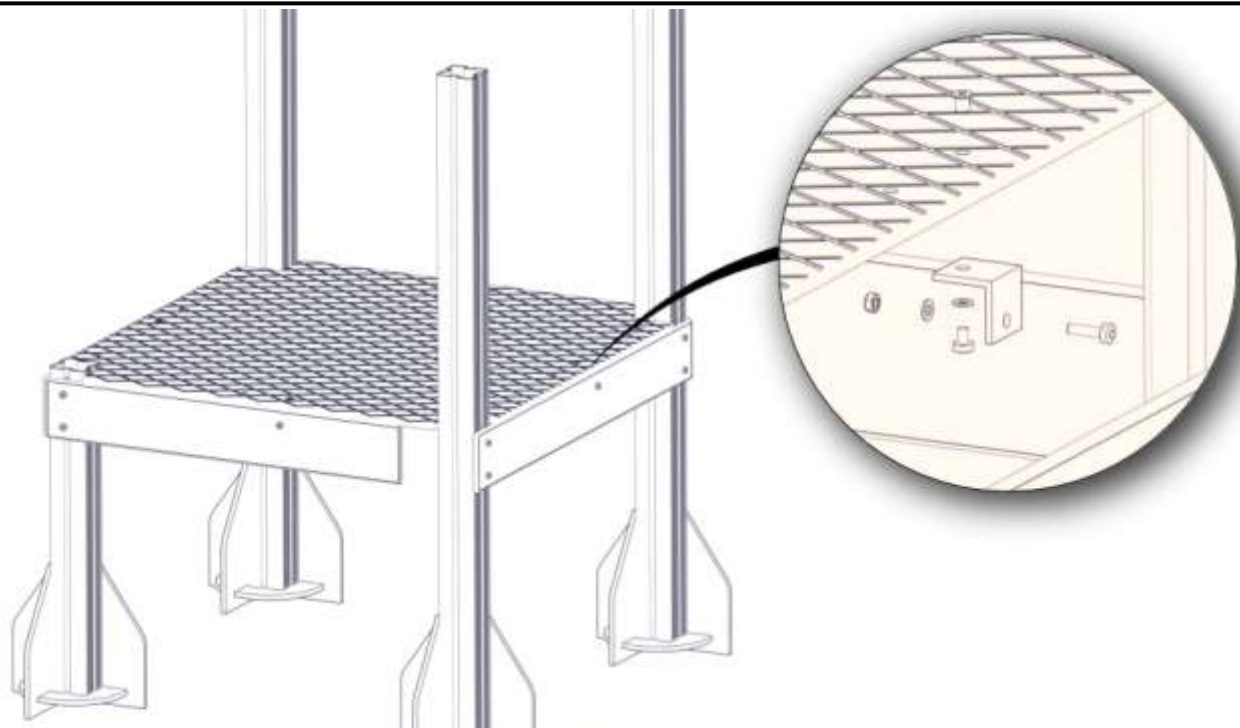

nr	PartName	Artnr	Antall
1	Gulv 1160x1160x15	00-400-300	1
2	Torx M8x12	04-000-012	4
3	Torx M8x30	04-000-030	4
4	Møbelknapp 16x11	04-030-011	4

nr	PartName	Artnr	Antall
5	Låsemutter M8	04-040-008	4
6	Skive M8	04-050-008	8
7	Vinkel 50x50x50x5 11mm hull	04-070-050	4

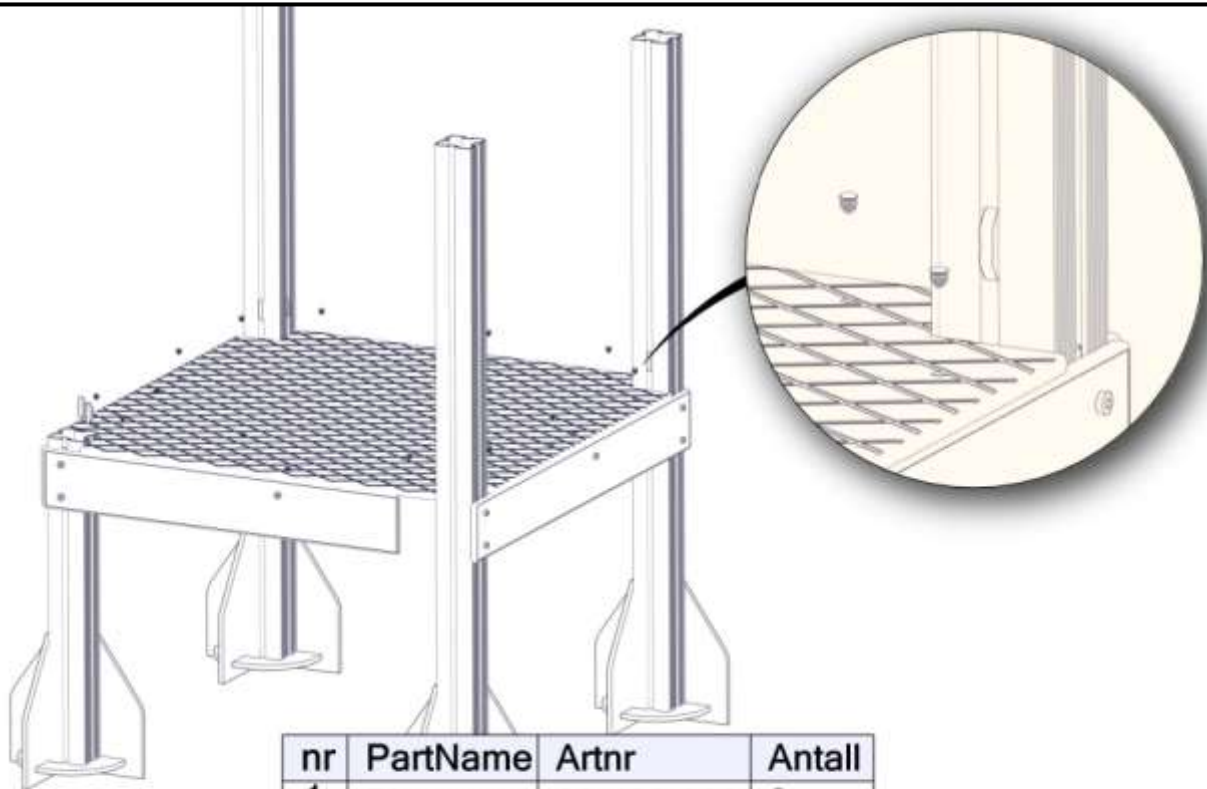

nr	PartName	Artnr	Antall
1	Plug spør	00-400-980	8
2	Plugg	04-090-002	13

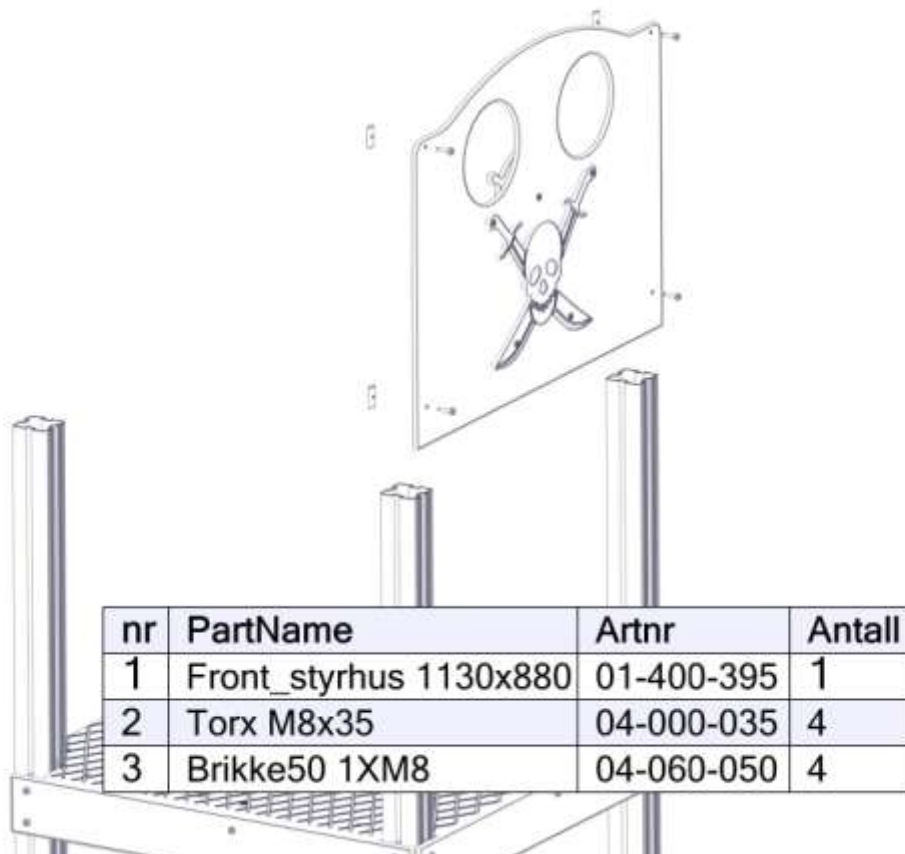

nr	PartName	Artnr	Antall
1	Front_styrhus 1130x880	01-400-395	1
2	Torx M8x35	04-000-035	4
3	Brikke50 1XM8	04-060-050	4

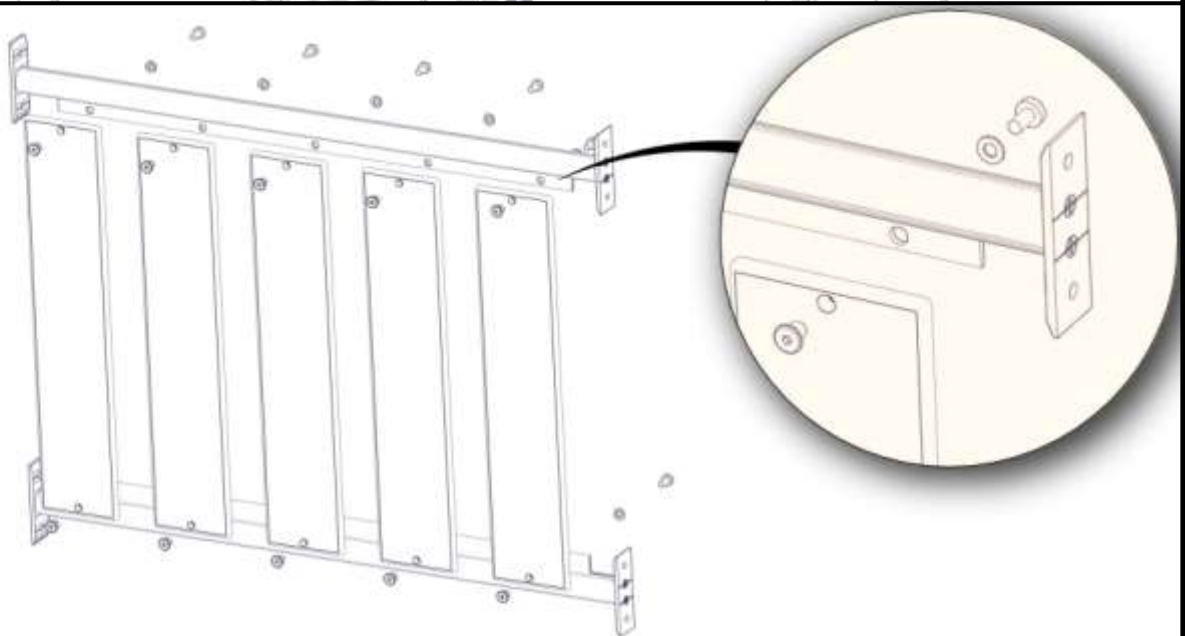
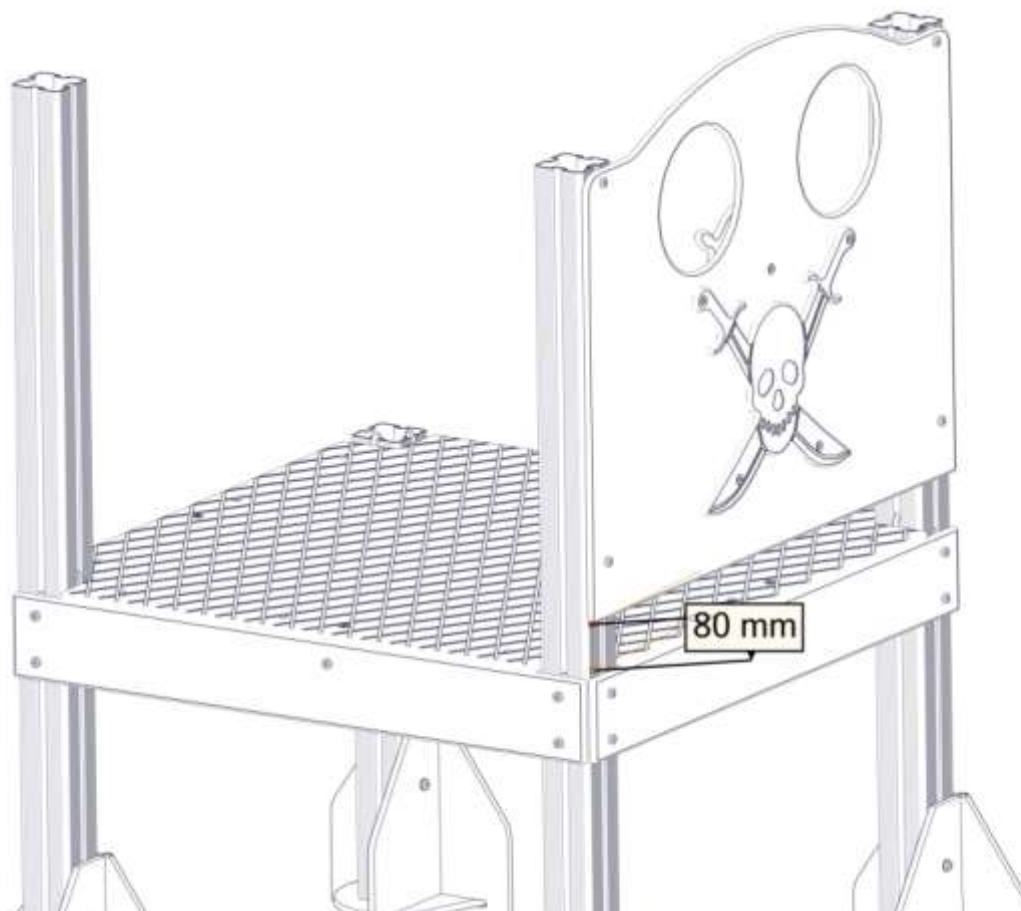

nr	PartName	Artnr	Antall
1	Sprosse rekkverk 594x122	01-400-256	5
2	Torx M8x16	04-000-016	10
3	Møbelknapp 16x11	04-030-011	10
4	Skive M8	04-050-008	10

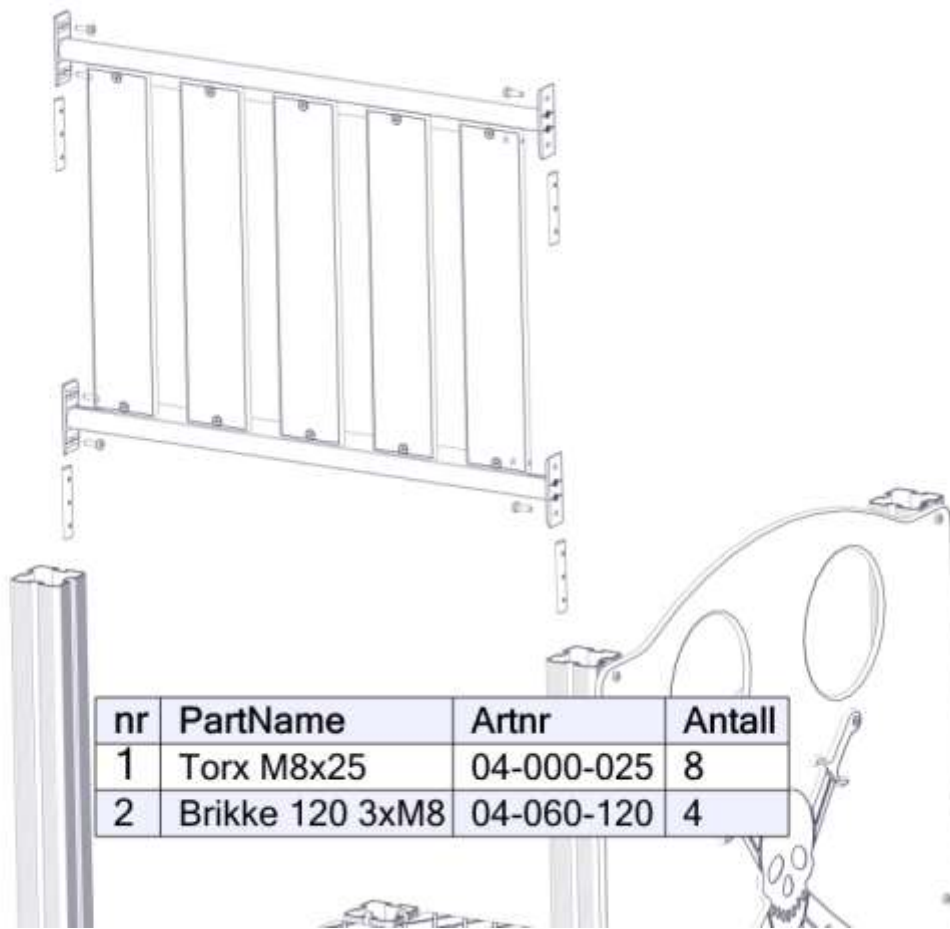

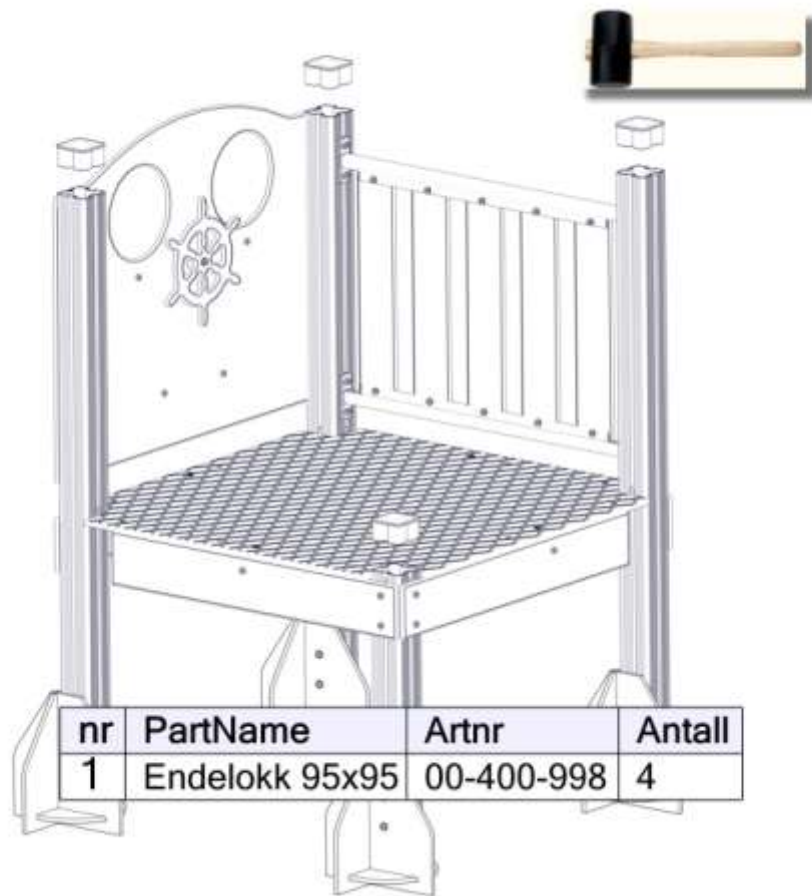



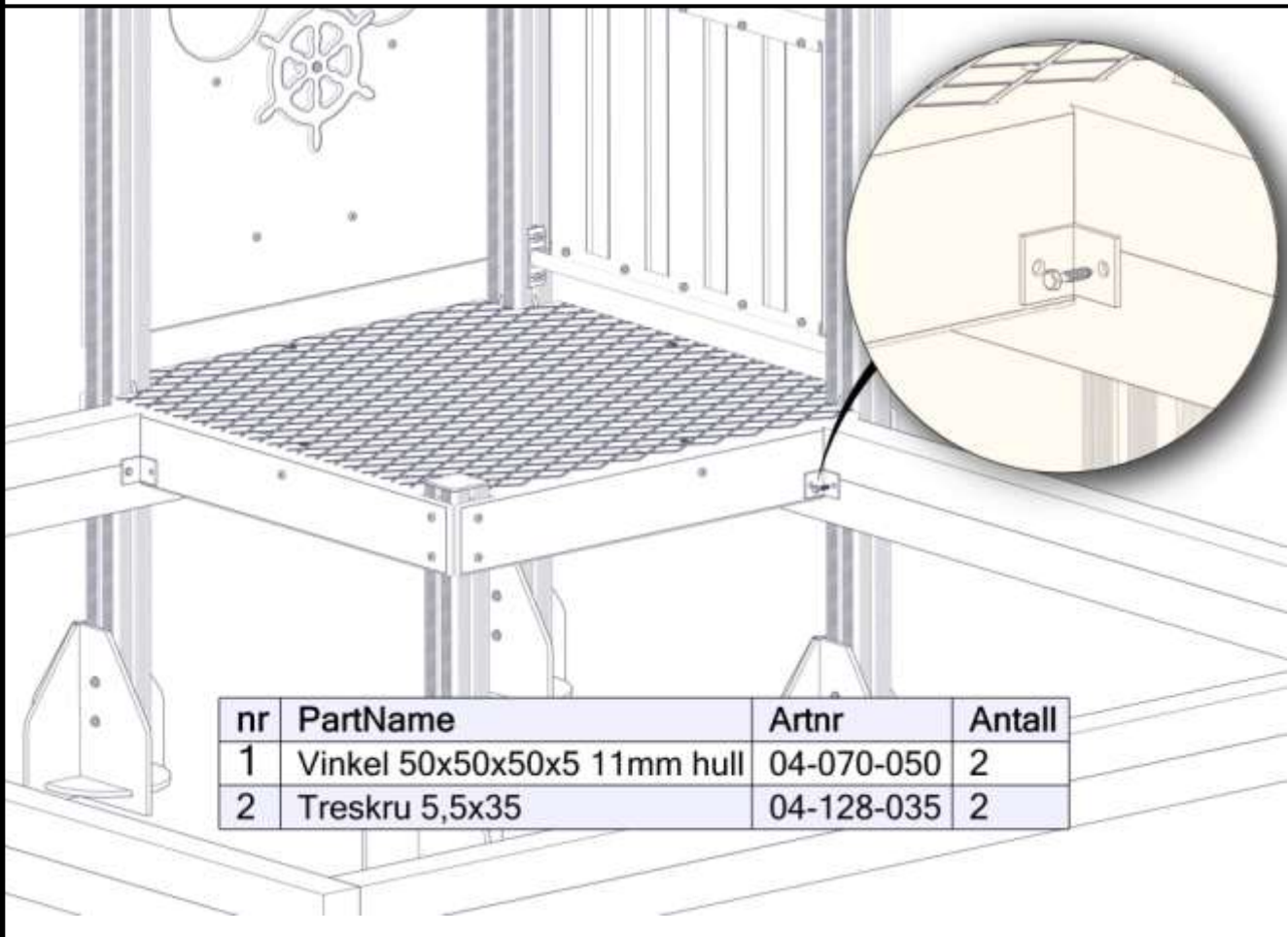



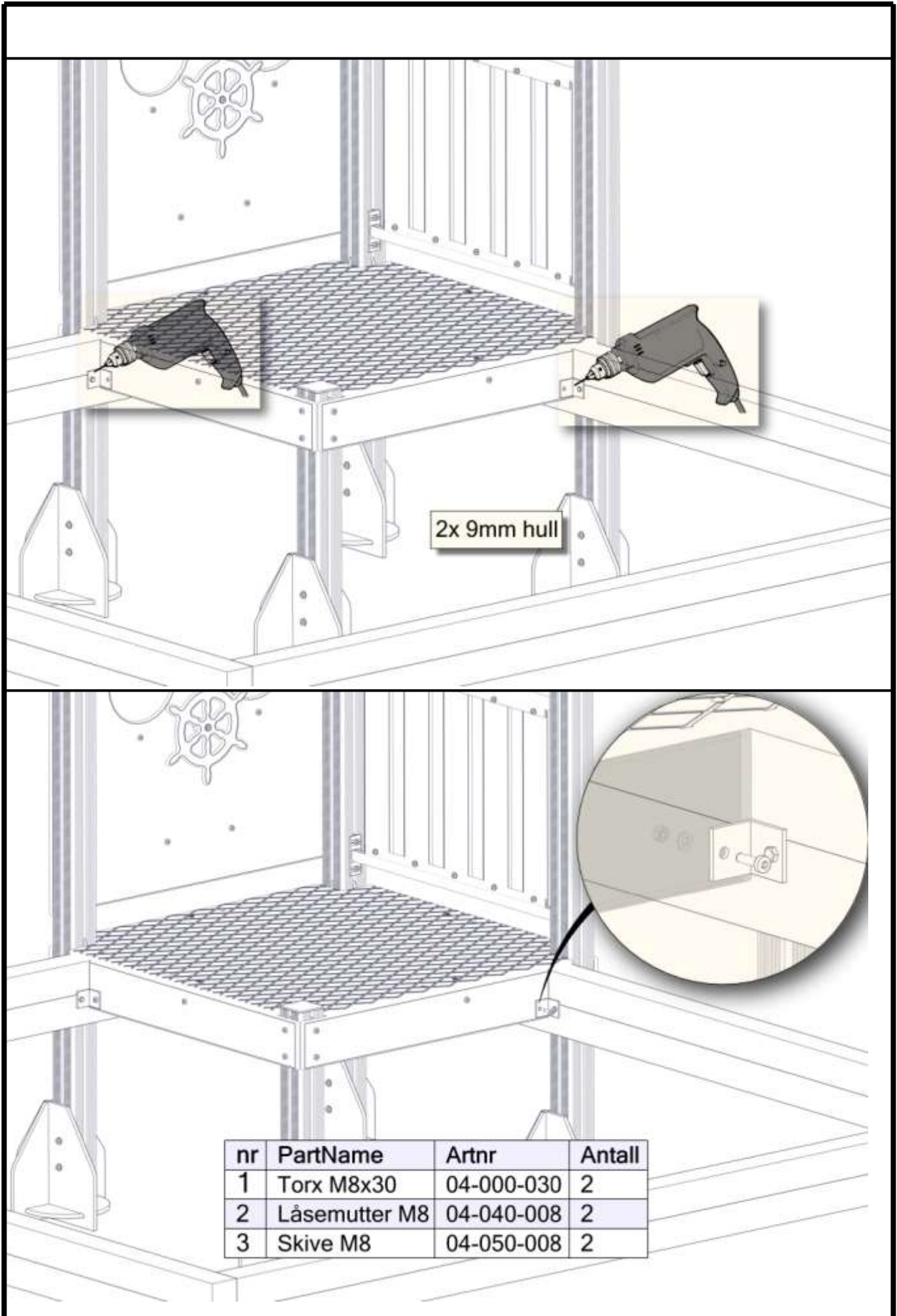



nr	PartName	Artnr	Antall
1	Endelokk 95x95	00-400-998	4



nr	PartName	Artnr	Antall
1	Vinkel 50x50x50x5 11mm hull	04-070-050	2
2	Treskru 5,5x35	04-128-035	2



Før utstyret tas i bruk / Before play begins / Innan lekredskapet tas i bruk	
N	<ul style="list-style-type: none"> ● Påse at fallunderlag er utlagt i henhold til gjeldende regler eller vår anbefaling ● Fjern alle monteringshjelpemidler (rester av betong, planker, paller, plast, og lignende) ● Før utstyret tas i bruk, burde man sjekke at det ikke er fare for at anorakksnorer og lignende som kan hekte seg fast noen steder på lekeapparatet. (Vedlagte snor med dobbe (kneledd) kan brukes til å sjekke at dette er i orden. Se vedlagte veiledning for bruk av denne. Dette gjøres for å oppdage eventuelle feilmonteringer.?) ● NB! Bør stå i 2-3 dager før bruk
EN	<ul style="list-style-type: none"> ● Make sure the area and depth of safer surfacing are according to the current standard, or to the manufacturer's recommendation ● Make sure all tools and surplus materials are removed before play begins ● PS! When complete, allow 2-3 days for the concrete to set before use
S	<ul style="list-style-type: none"> ● Kontrollera att fallunderlag är utlagt enligt gällande regler eller vårt rekommendation ● Ta bort alla monteringshjälpmedel (rester av betong, plankor, pallar, plast och liknande) ● Innan lekredskapet används, kontrollera att anoracksnoddar eller kläder/delar av kläder eller liknande inte kan fastna i några delar på redskapet. (Den bipackade "knävringen" kan man med fördel användas för denna kontroll. ● Detta görs för att upptäcka eventuella felmonteringar.)

Boltepakker for / Boltpackage for / Bultpaket för			Sign. _____
	Torx M8x12 04-000-012	4	Brikke 50-1T 04-060-050
	Torx M8x16 04-000-016	10	Brikke 120-3T 04-060-120
	Torx M8x25 04-000-025	8	Brikke 150-3T 04-060-150
	Torx M8x30 04-000-030	4	Vinkel 50x50x50 04-070-050 11mm
	Torx M8x35 04-000-035	20	
	Møbelknapp M8x13x17 04-030-011	14	Skive M8 04-050-008
			Låsemutter M8 04-040-008
	Plast plug 9-11mm 04-090-002	16	 Treskru 5,5x35 2 04-128-035
	Plug spor 00-400-980	8	
	Gulv 1160x1160x15 00-400-300	1	Sprosse 1160x145x15 01-400-108
			Sprosse 940x145x15 01-400-115
	Skute vegg Med styr og hode	1	Sprosse rekkverk 01-400-256
	Sperrerør rekk- verk 01-400-254	2	Stolpe VK95 L=800
			Stolpe VK95 L=1650
	Eventuelt fun- damenter	4	Ende lokk 00-400-996