

N**Monteringsanvisning****EN****Assembly Instructions****S****Monteringsanvisning**

Produkt nr. / Product no. / Produkt nr.

60-164-801**Grå/rød**

Ord. nr. _____

Dato. _____

Sign. _____

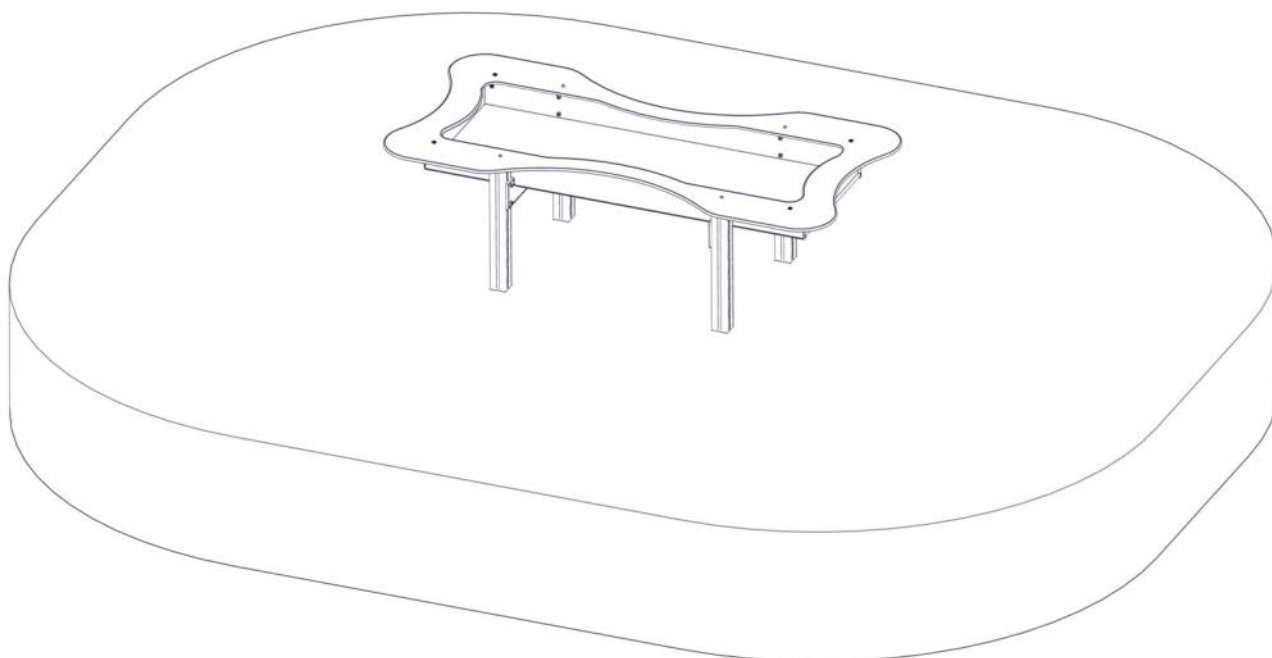
**søve**

Søve AS
Grønnvoldveien 290
3830 Ulefoss - Norway
Tlf: +47 35 94 65 65
www.sove.no

**søve**

Søve AB
EA Rosengrensgatan 32
421 31 Västra Frölunda
Phone: +46 (0)31 773 97 00
www.sove.se

Monteringstips / Assembly Advice / Monteringsstips**N**

- Les monteringsanvisningen nøye før montering.
- Monter elementene i rekkefølgen som vist.
- Boltene bør ikke skrues for hardt til før alt er montert, vatret og loddet. Skru så boltene til.
- NB! Ved bruk av drill, kan boltene ryke.
- På grunn av at solen kan gjøre rutsjeflaten veldig varm, bør rutsjebanens utløp vende mot nord-øst eller nord-vest.
- Er lekeutstyret plassert i naturlige ferdselstraséer må området sikres mot gjennomgang.
- Innspringningshinder bør vurderes rundt lekeapparater hvor det er stor bevegelse, f.eks. ved huskestativ.
- Det bør være fritt innsyn til lekeutstyr som er beregnet for barn under 3 år.

NB! Under monteringsarbeidet må utstyr, som ikke er forankret forsvarlig i bakken, sikres slik at det ikke velte.

Området må avstenges under montering av apparatene med sperrebånd eller lignende.

EN

- Read the instruction carefully before assembling the play unit.
- Assemble the components in the sequence shown in these instructions. Fixings must not be fully tightened during assembly. Before casting the foundations, the structure must be level and plumb, at which point all fixings are tightened. PS! If use of drill, the bolts may be wrecked.
- Avoid positioning the slide facing due south because of overheating – ideal positions are facing north-east or north-west. Secure the construction-area to prevent people from walking through it.
- Consider installing barriers around play-equipment which gives rise to a lot of activity – i.e. swings.
- Ensure that clear vision is possible across the play area so that supervision is possible from any position, particularly where children under 3 years of age will be playing.

NB! During assembly of the equipment, ensure that all structures are securely propped, especially when left overnight. Also ensure that equipment is supported

Monteringstips / Assembly Advice / Monteringsstips**S**

- Läs monteringsanvisningen noga före montering.

- Montera delarna i den ordningen som anvisas
- Skruvarna bör inte skruvas för hårt tills allt är monterat, i våg och lodat.









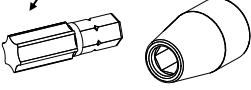

OBS! Används elektrisk skruvdragare, kan bulten gå sönder. Hårdra därför manuellt!

- Solen kan göra att rutchbanan blir väldigt varm. Banans nedfart rekommenderas att vändas i norrlig riktning
- Om lekplatsen placeras vid en gångväg mm bör området säkras mot genomfart av gående och cyklister.
- Insprängningshinder bör placeras runt lekutrustning med stor rörelse, t ex, gungställning.
- Det bör vara fri insyn till lekutrustning beräknat till barn under 3 år.

OBS! Under monteringsarbete bör utrustningen som inte ska förankras i marken, ställs så att den inte kan välta.

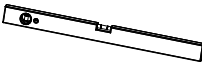
Området måste spärras när lekutrustningen byggs upp, med avspärrningsband eller liknande.

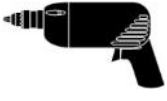
Nødvendig verktøy / Tools required / Nödvändiga verktyg

<p>(N)</p> <p>(EN)</p> <p>(S)</p>	<p>(A)</p> 	<p>(B)</p>  <p>Torx Nr 45 High quality</p> 	<p>(C)</p>  <p>13 + 17mm</p> 	<p>(D)</p> 	<p>(E)</p> 
		<p>Metermål</p> <p>Metric measure</p> <p>Tumstock</p> 	<p>16 V</p> 	<p>Merkebånd</p> <p>Mark ribbon</p> <p>Märkeband</p> 	<p>5 mm</p> <p>6 mm</p> 

Nødvendig antall personer / Number of persons required / Rekommenderad antal personer





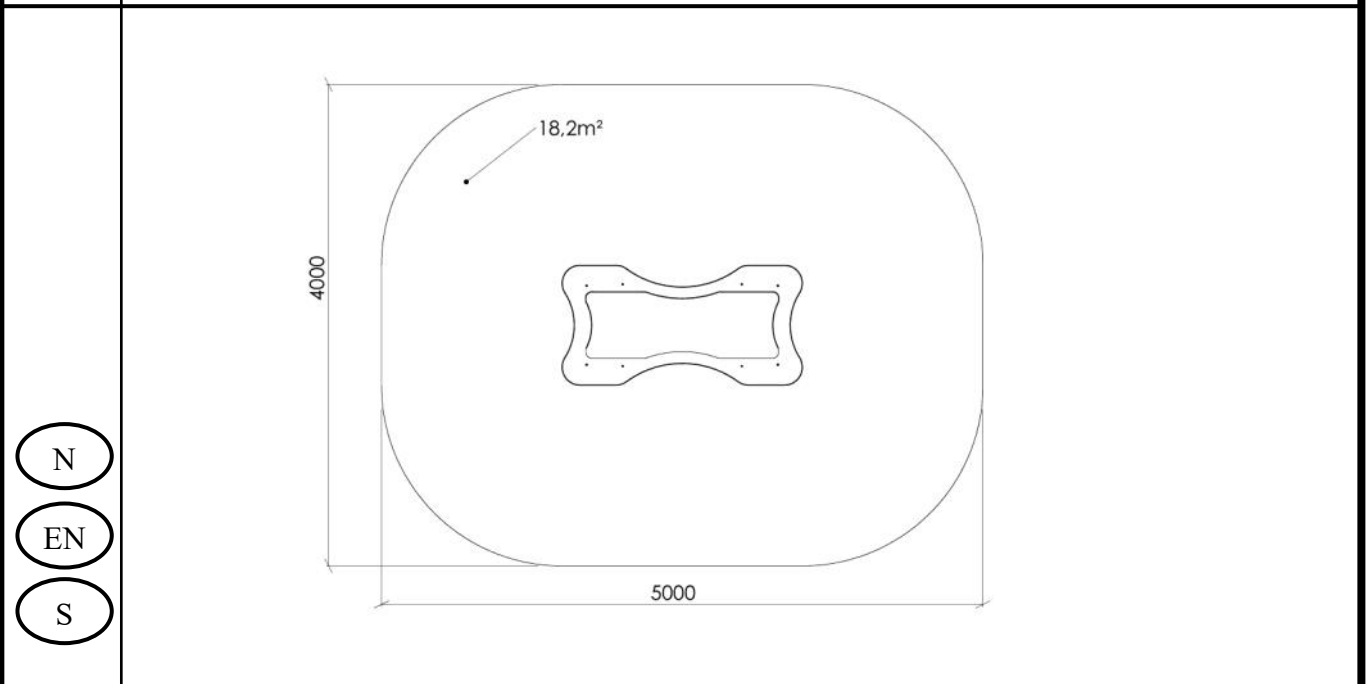



Anbefalt arealbehov ved montering / Recommended working space / Rekommenderad arealbehov vid montering

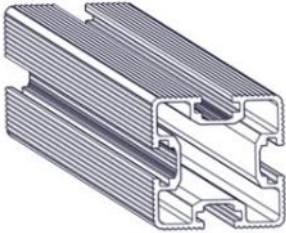

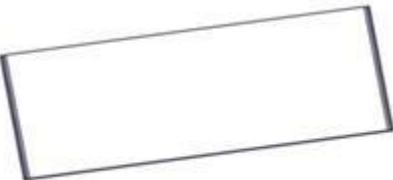
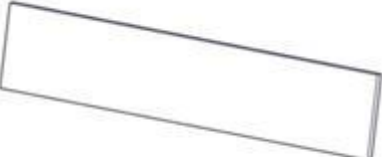
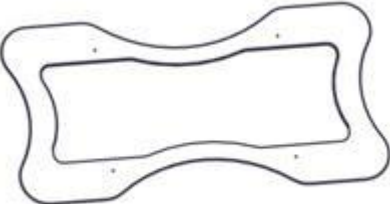
Boltepakker for / Boltpackage for / Bultpaket för

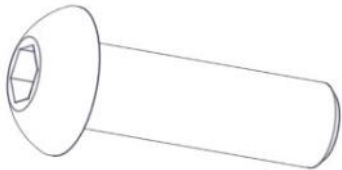
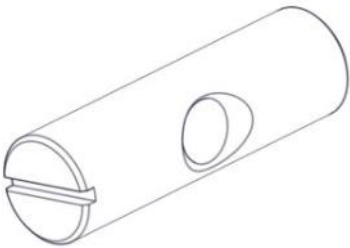
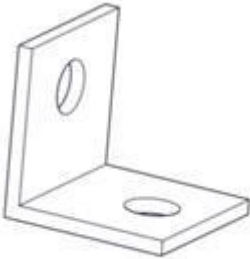
Sign. _____

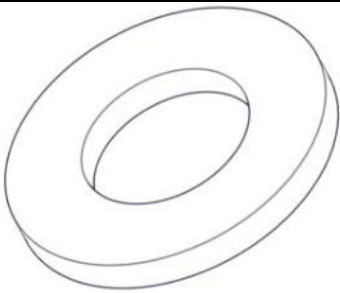
Grå- rød 60-164-801	Navn	Artnr/ dimensjon	Ant	Lev
	Stolpe 70x70 L=1000 (400-600) Sort Med hull for hylsemutter	07-530-050	4	
	Sandlekebord rektangel sprosse stotte Grå	07-530-049K (Se egen delmontering)	2	
	Sandlekebord rektangel sprosse lang Grå	07-530-047K (Se egen delmontering)	2	
	Sandlekebord rektangel bonnplate Brun	07-530-041	1	
	Sandlekebord rektangel sprosse kort Grå	07-530-048	2	
	Sandlekebord rektangel topplate Rød	07-530-045	1	

Boltepakker for / Boltpackage for / Bultpaket för		Sign. _____.		
Grå- rød 60-164-801	Navn	Artnr/ dimensjon	Ant	Lev
	Unbrako skrue M8x40 linsehode	04-035-040	4	
	Hylsemutter Ø12x70 1xM8	04-019-070	4	
	Vinkel 35x35x35x3 11mm hull	04-070-036	4	
	Torx M8x12	04-000-012	8	
	Skive M8	04-050-008	8	
	Møbelknapp M8x11	04-030-011	8	

Boltepakker for / Boltpackage for / Bultpaket för

Sign. _____.

Grå- rød 60-164-801	Navn	Artnr/ dimensjon	Ant	Lev
	Produktmerke Montert hos Søve	00-100-400 (montert hos Søve)	0	

Boltepakker for / Boltpackage for / Bultpaket för

Sign. _____

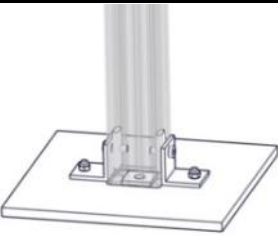
Grå- rød 60-164-801	Navn	Artnr/ dimensjon	Ant	Lev
	Fundament Støp			
	Støpefundament 70 x 70 stolpe	00-003-112K (se egen delmontering)	4	
	Fundament Nedgravning			
	Nedgravningsfundament 70 x 70 stolpe	07-510-207K (se egen delmontering)	4	

Boltepakker for / Boltpackage for / Bultpaket för

Sign. _____.

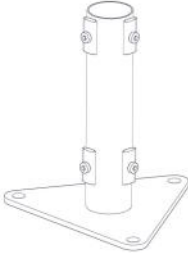
Grå- rød 60-164-801	Navn	Artnr/dimensjon	Ant	Lev
	Overflate montering			
	Fundament 70x70 for Betongdekke	00-003-129K (se egen dekemontering)	4	
	Stolpe kappes	07-530-050	4	

Fundamentering med betong / Foundation concrete / Förankring med betong

(N) Støtdempende materialer

(EN) Impact attenuating materials

(S) Støtdämpande material Ref NS-EN 1176-1 §4.2.8.5



(N) (EN) (S)
Bakkenivå Ground level Marknivå

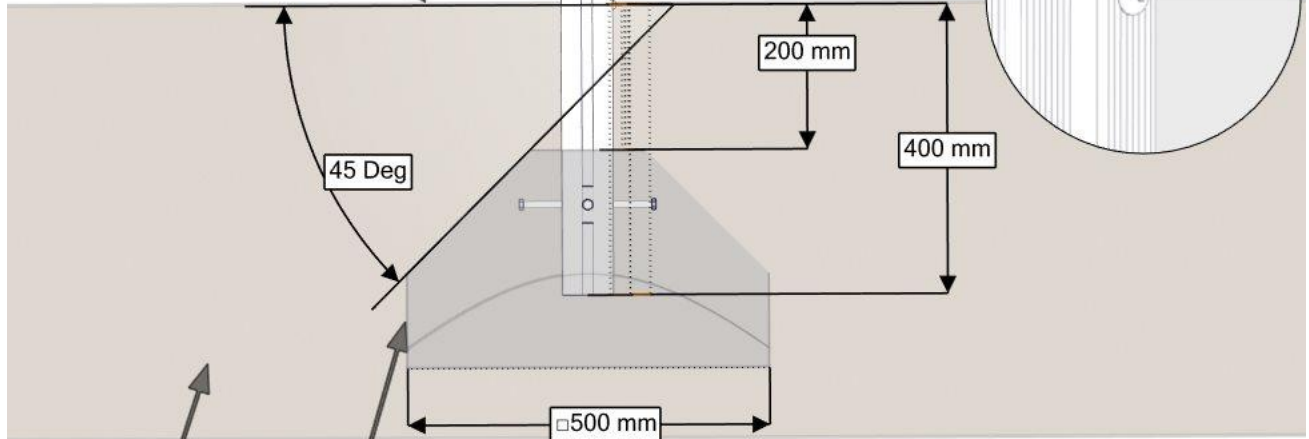

(N) Komprimert masse Betong

(EN) Compressed mass Concrete

(S) Komprimerad massa Betong

Fundamentering uten betong / Foundation without concrete / Förankring utan betong

(N) Støtdempende materialer

(EN) Impact attenuating materials Ref NS-EN 1176-1 §4.2.8.5

(S) Støtdämpande material

(N) (EN) (S)
Bakkenivå Ground level Marknivå

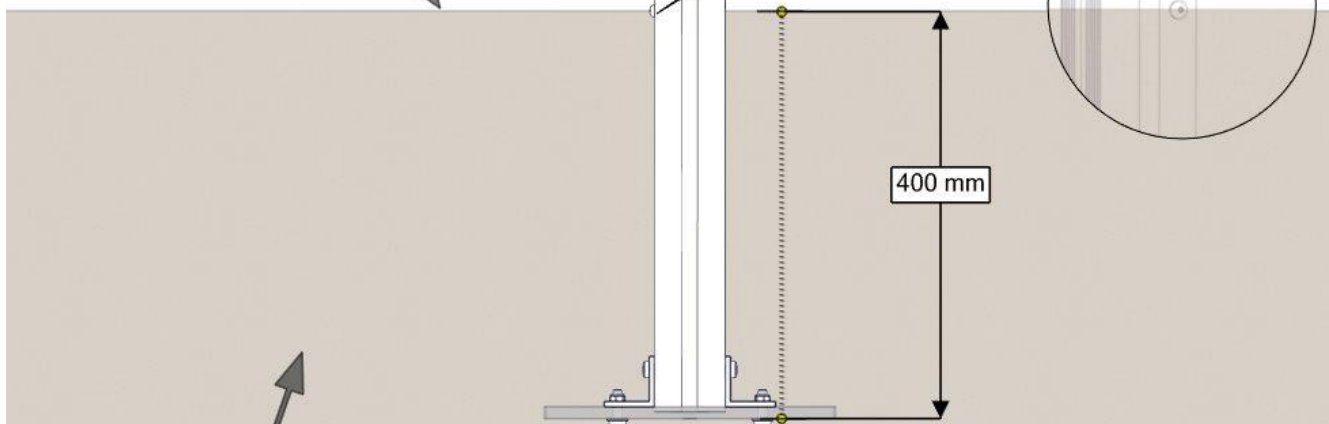

(N) Komprimert masse Støpefri nedgraving

(EN) Compressed mass Concrete-free anchor

(S) Komprimerad massa Nedgrävningfundament

Overflatemontering / Surface mounting / Ytmontering

Ref
NS-EN 1176-1
§4.2.8.5

(N) (EN) (S)
Bakkenivå Ground level marknivå

Tykkelse/Thickness

betong
concrete
betong

Stolpe kappes: Lengde stolpe - 400 + tykkelse

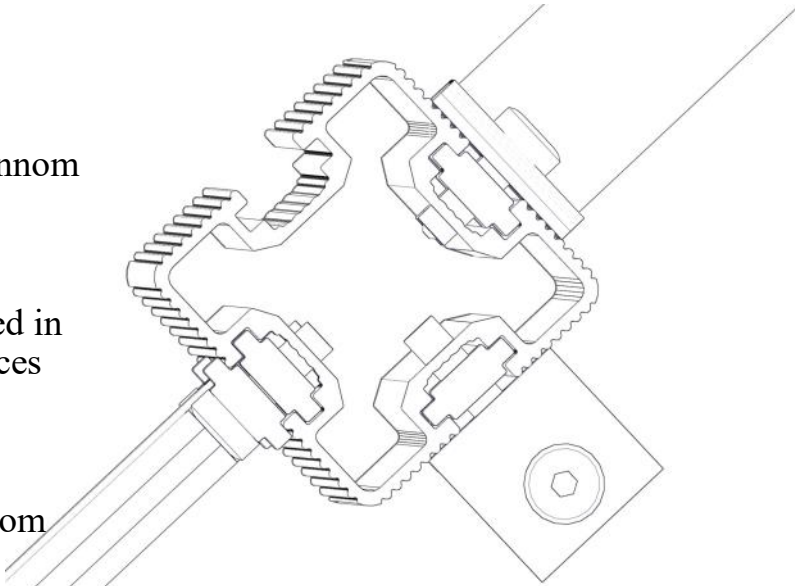
N	<p>Bolten skrues HELT igjennom aluminiumen. Maks moment: 30Nm</p>	
EN	<p>The bolt must be tightened in to the post, so that it pierces the aluminium Max torque: 30Nm</p>	
S	<p>Bulten skruvas HELT genom aluminiumen. Maks vridmoment: 30Nm</p>	

NO	Betongkvalitet	C25/30		
SE	Betongkvalitet			
EN	Concrete quality			
NO	Mengde betong		0,3	m ³
SE	Mängd betong			
EN	Amount of concrete			
NO	Fundament størrelse		0,4 x 0,4 x 0,4	m
SE	Stiftelsestorlek			
EN	Foundation size			
NO	For sikkerhet må fundamentene med sand eller myk jord være minst 50% større i areal			
SE	För säkerheten måste grunden med sand eller mjuk jord vara minst 50% större i området			
EN	For safety, the foundations with sand or soft soil must be at least 50% larger in area			
NO	Tyngste element	07-530-045	13,5	Kg
SE	Tyngsta element			
EN	Heaviest element			
NO	Største element	07-530-045	2x1	m
SE	Största element			
EN	Biggest element			

Fallhøyder / Free height of fall / Fallhöjder

Fallhøyde = 0,6 meter

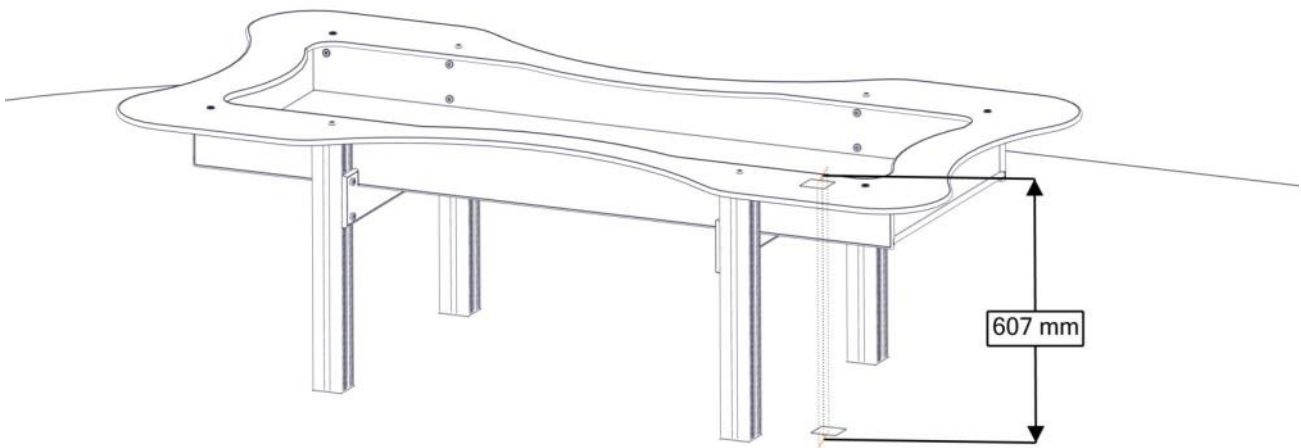
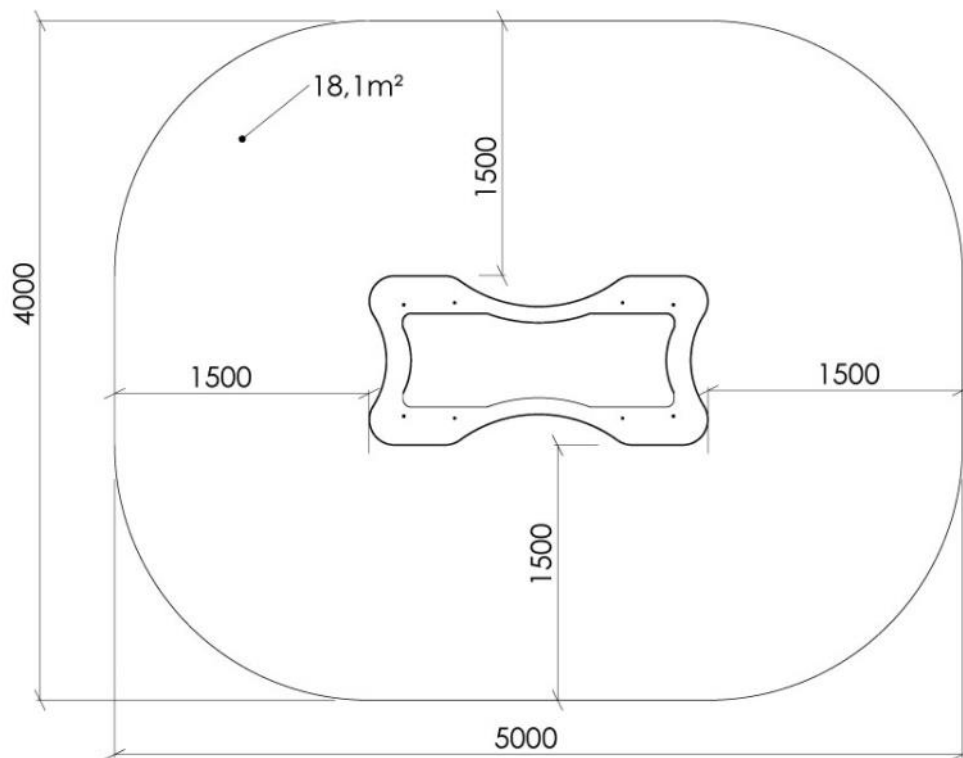
**Sikkerhetszone / Safety zone / Säkerhetszon**

Montering av lekeapparatet / Assembly instructions / Montering av lekredskapet

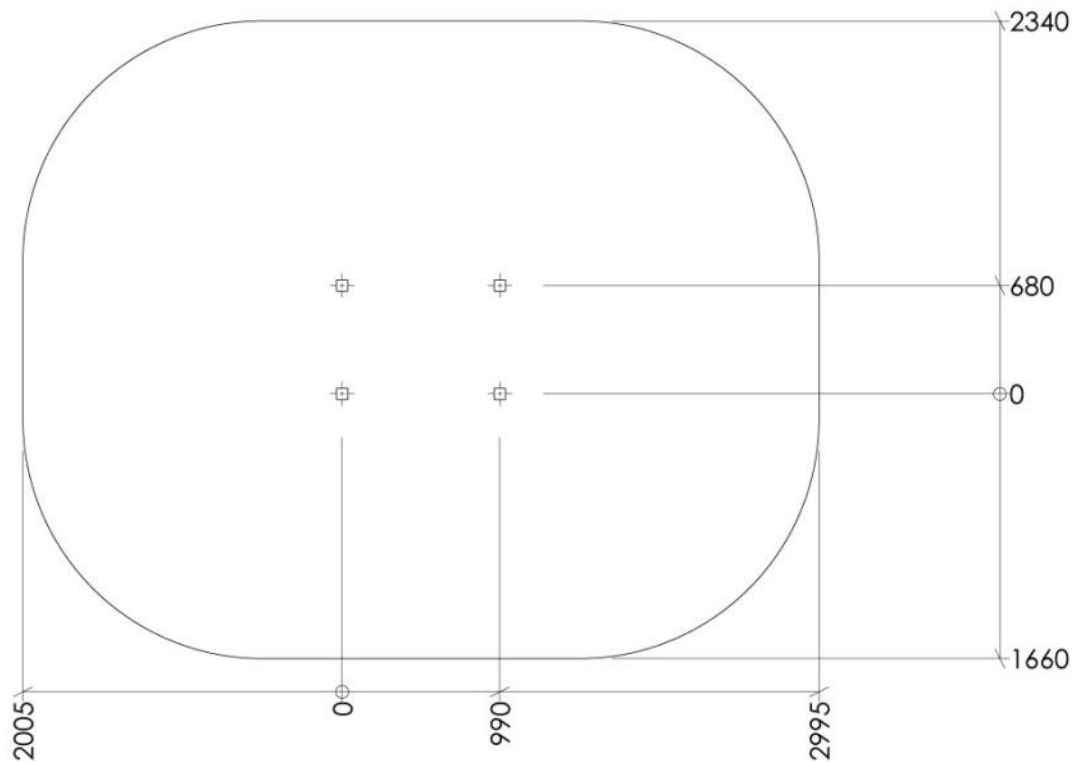

4x

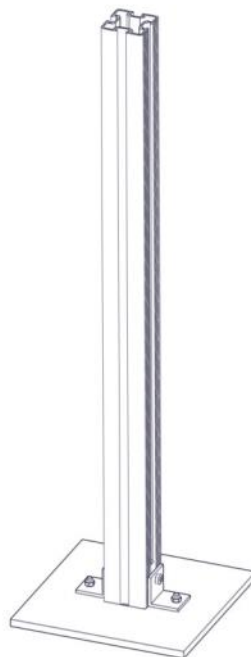

Part Name	Article nr.	Qty
Stolpe 70x70 L= 1000 med hull for hylsemutter	07-530-050	1
Fundament skive 70x70 stolpe	07-510-207K	1

Se separat delmontering for detaljer
 See separate assembly for details
 Se separata delmontering för detaljer

Plasser deler, men stram boltene senere
 Place part but tighten the bolts later

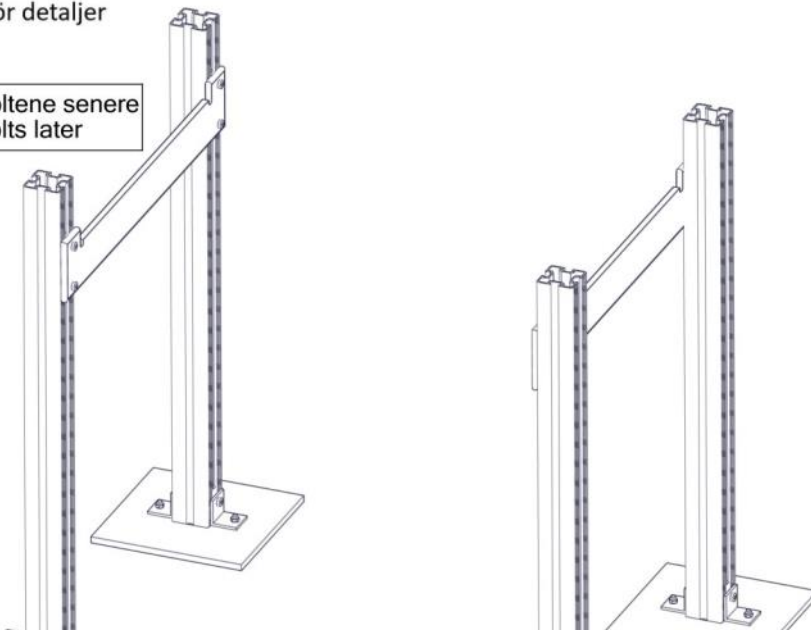

Part Name	Article nr.	Qty
Sandlekebord rektangel sprosse støtte	07-530-049K	2

Se separat delmontering for detaljer
 See separate assembly for details
 Se separata delmontering för detaljer

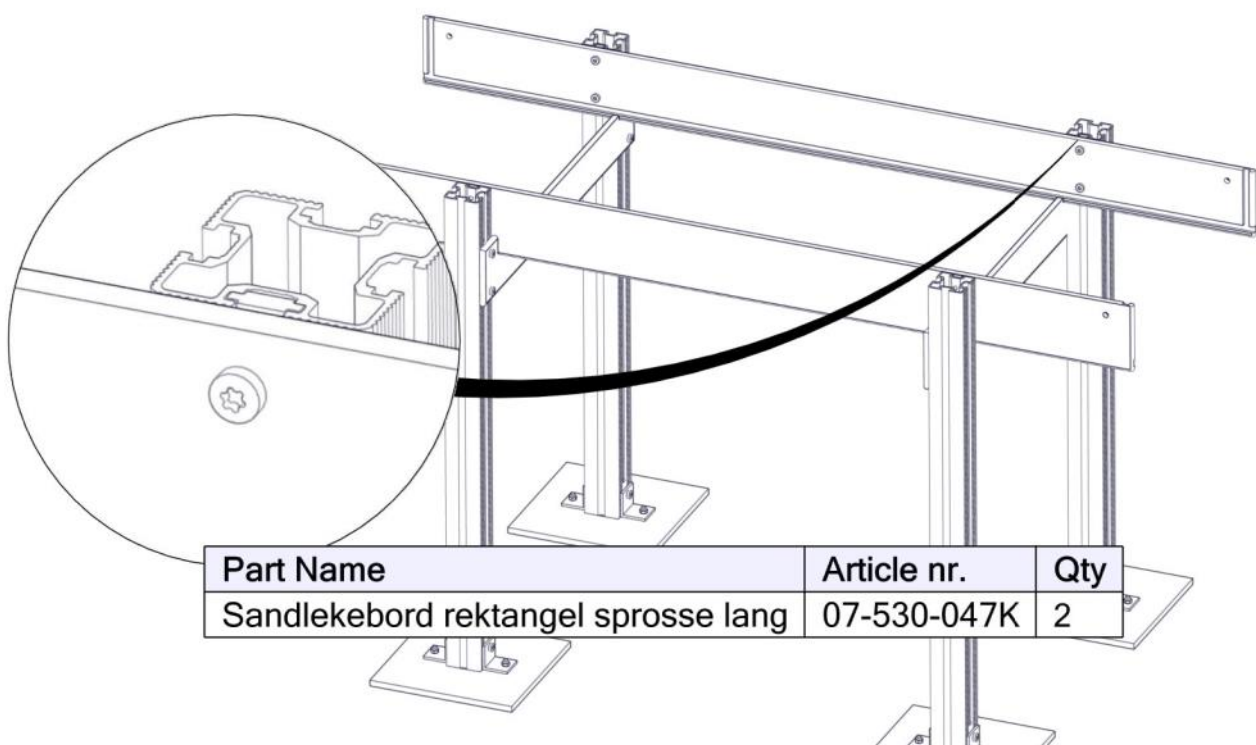

Part Name	Article nr.	Qty
Sandlekebord rektangel sprosse lang	07-530-047K	2

Stram boltene,
Tighten the bolts

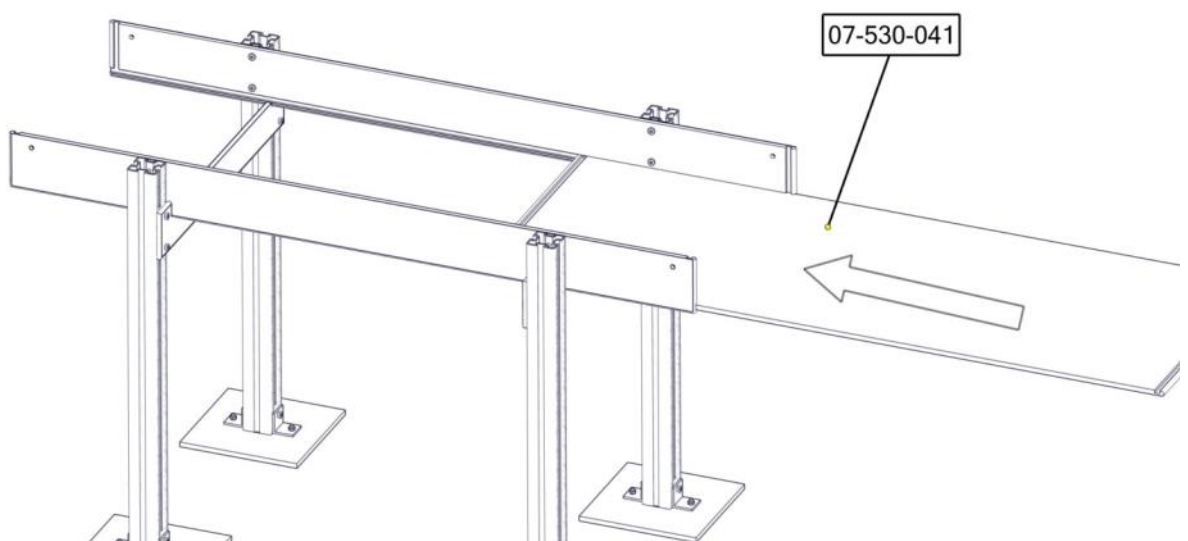
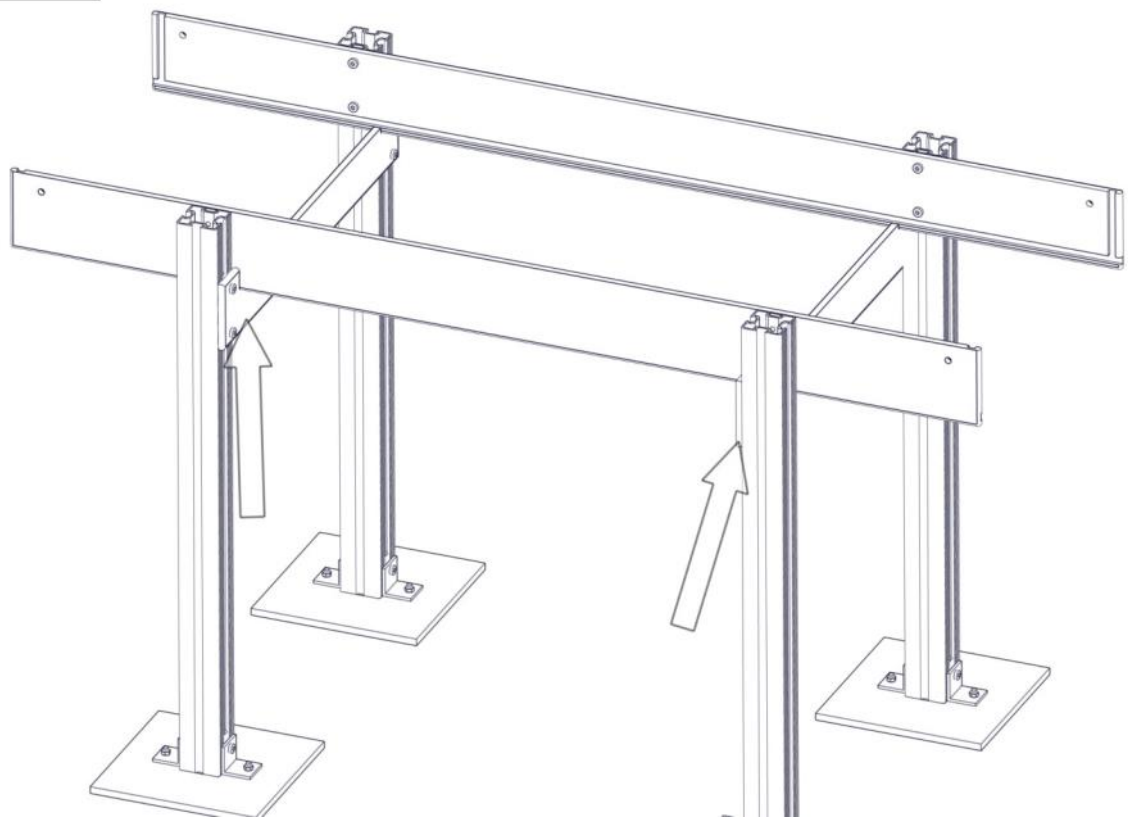

Part Name	Article nr.	Qty
Sandlekebord rektangel bonnplate	07-530-041	1

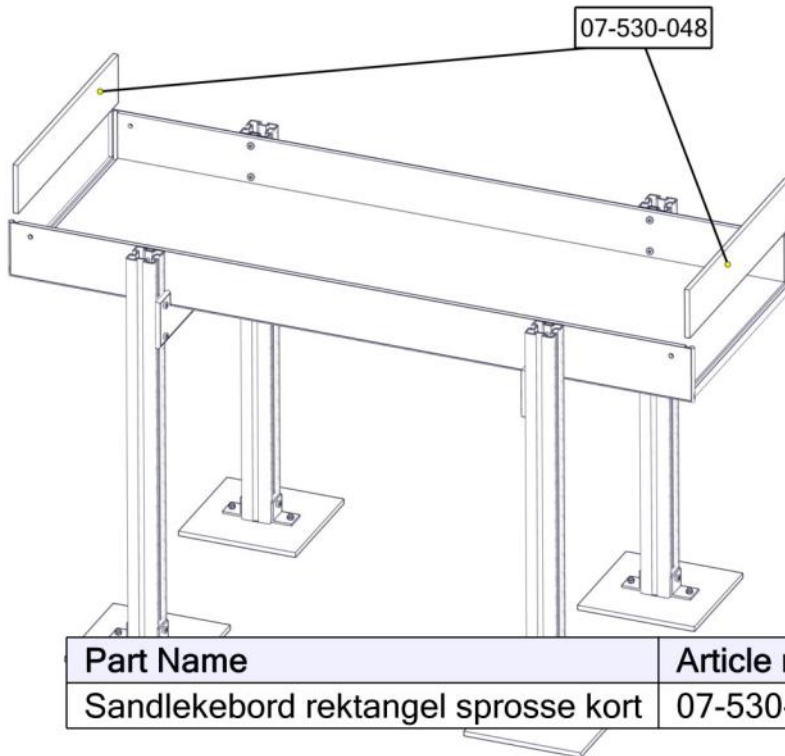

Part Name	Article nr.	Qty
Sandlekebord rektangel sprosse kort	07-530-048	2

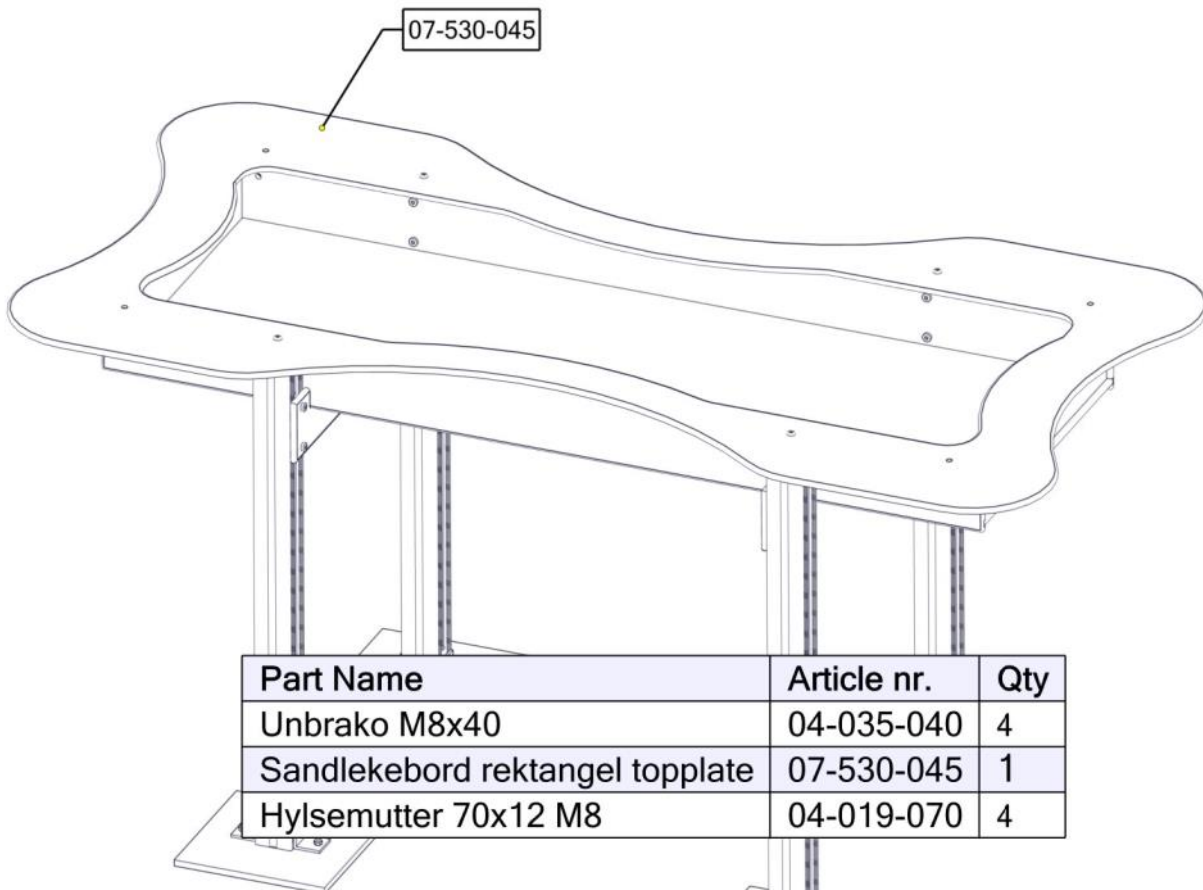

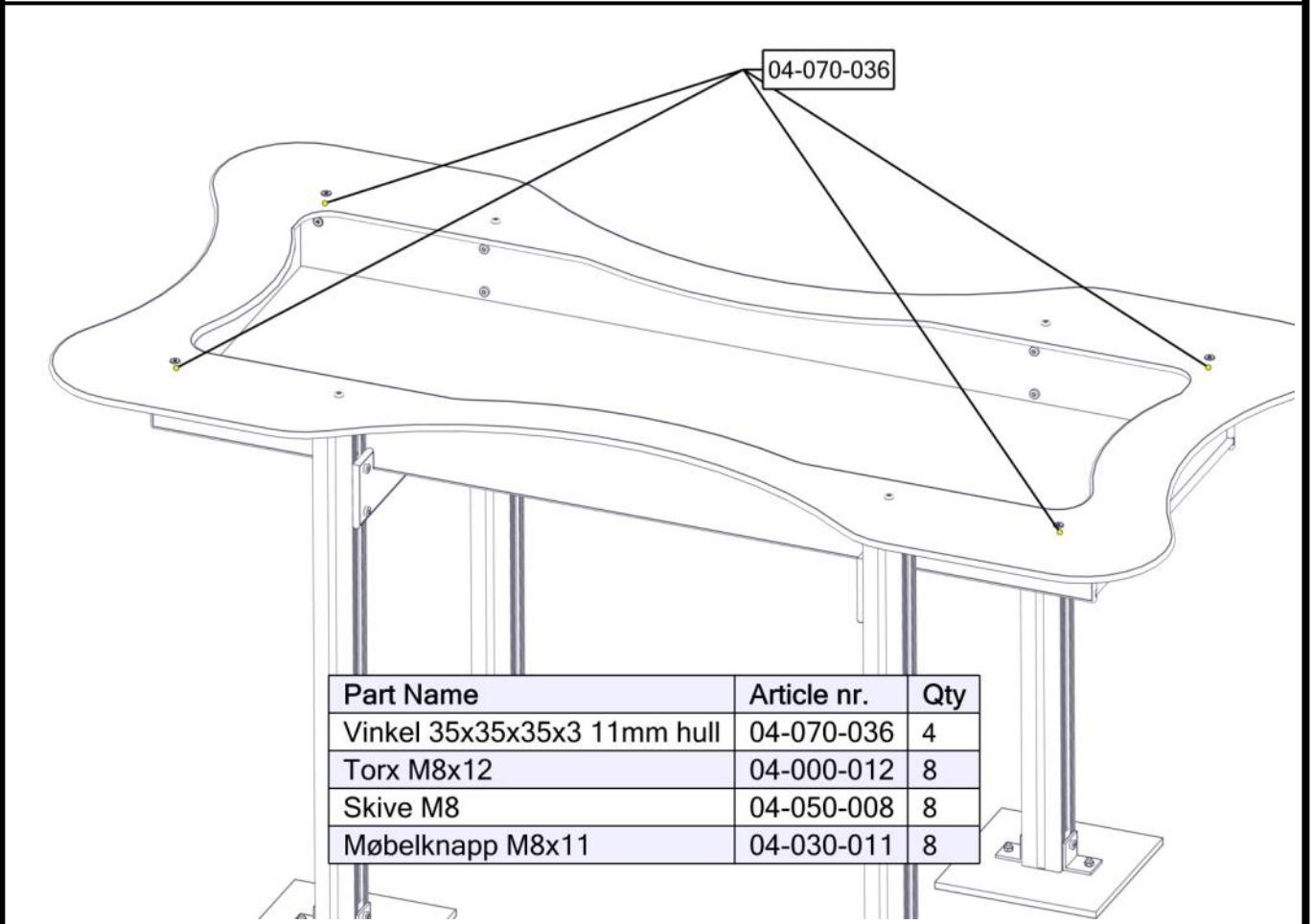
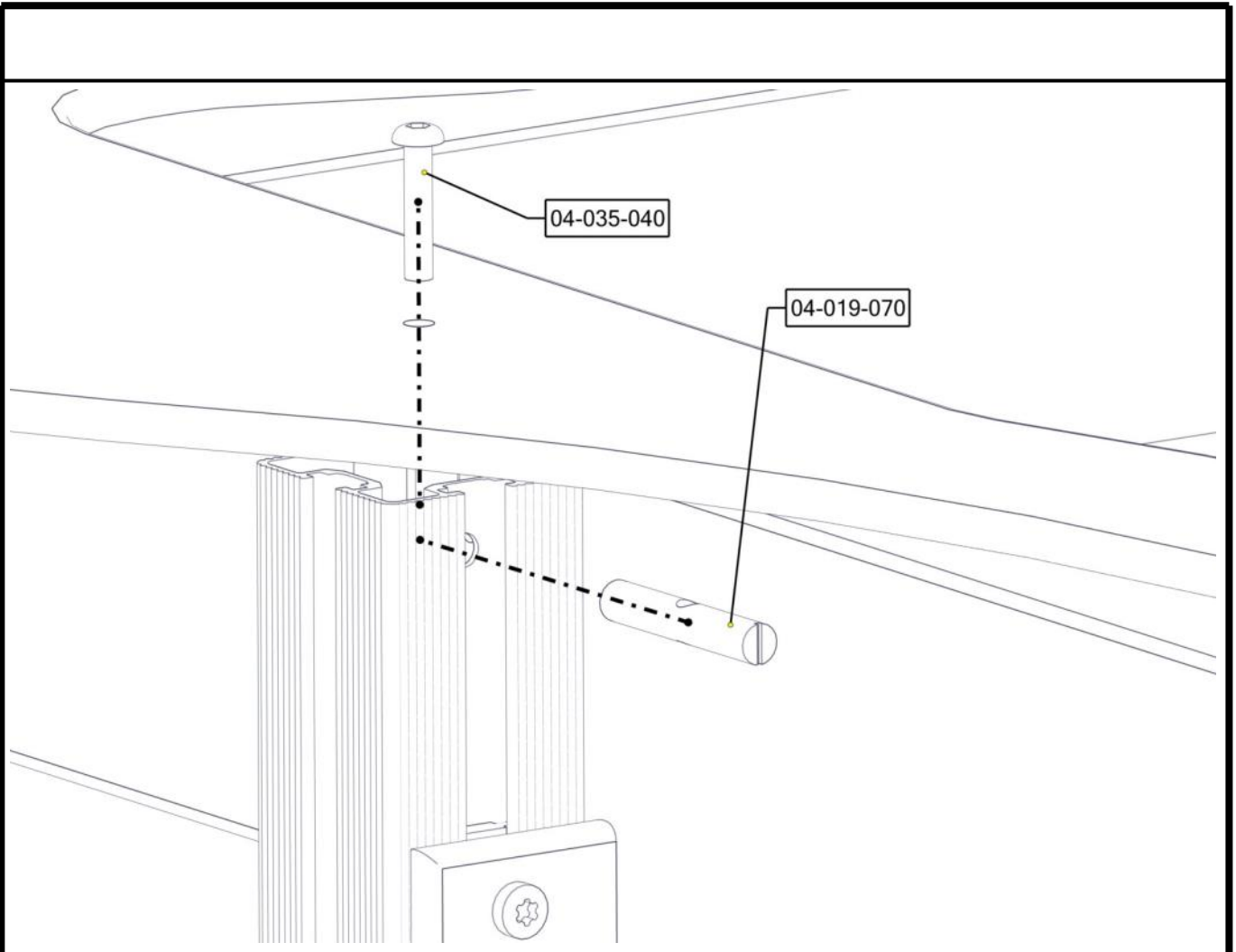

Part Name	Article nr.	Qty
Unbrako M8x40	04-035-040	4
Sandlekebord rektangel topplate	07-530-045	1
Hylsemutter 70x12 M8	04-019-070	4



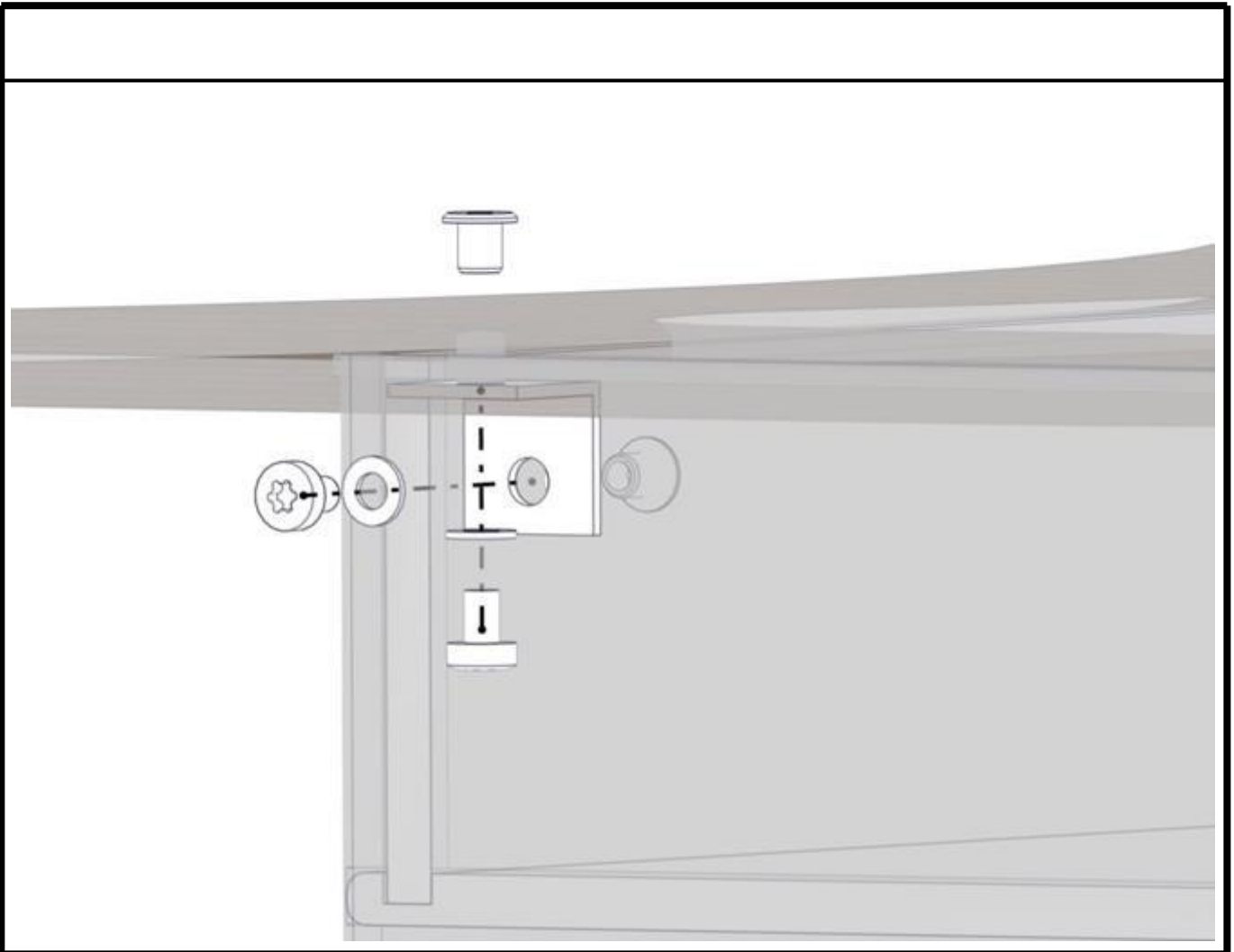

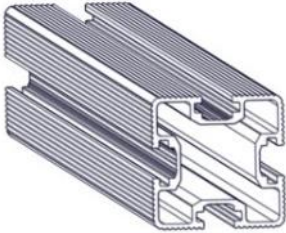

Part Name	Article nr.	Qty
Vinkel 35x35x35x3 11mm hull	04-070-036	4
Torx M8x12	04-000-012	8
Skive M8	04-050-008	8
Møbelknapp M8x11	04-030-011	8

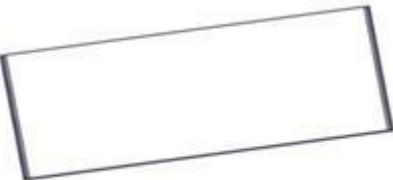
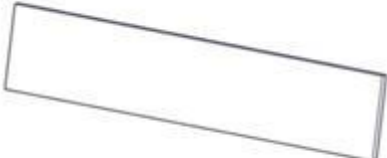
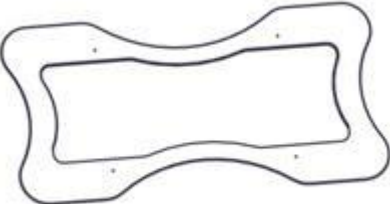

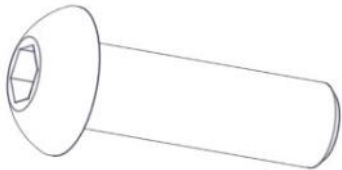
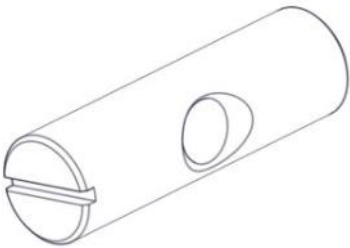
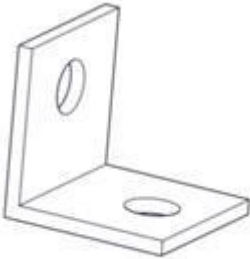
Før utstyret tas i bruk / Before play begins / Innan lekredskapet tas i bruk	
N	<ul style="list-style-type: none"> ● Påse at fallunderlag er utlagt i henhold til gjeldende regler eller vår anbefaling ● Fjern alle monteringshjelpemidler (rester av betong, planker, paller, plast, og lignende) ● Før utstyret tas i bruk, burde man sjekke at det ikke er fare for at anorakksnorer og lignende som kan hekte seg fast noen steder på lekeapparatet. (Vedlagte snor med dobbe (kneledd) kan brukes til å sjekke at dette er i orden. Se vedlagte veiledning for bruk av denne. Dette gjøres for å oppdage eventuelle feilmonteringer.?) ● NB! Bør stå i 2-3 dager før bruk
EN	<ul style="list-style-type: none"> ● Make sure the area and depth of safer surfacing are according to the current standard, or to the manufacturer's recommendation ● Make sure all tools and surplus materials are removed before play begins ● PS! When complete, allow 2-3 days for the concrete to set before use
S	<ul style="list-style-type: none"> ● Kontrollera att fallunderlag är utlagt enligt gällande regler eller vårt rekommendation ● Ta bort alla monteringshjälpmedel (rester av betong, plankor, pallar, plast och liknande) ● Innan lekredskapet används, kontrollera att anoracksnoddar eller kläder/delar av kläder eller liknande inte kan fastna i några delar på redskapet. (Den bipackade "knävringen" kan man med fördel användas för denna kontroll. ● Detta görs för att upptäcka eventuella felmonteringar.)

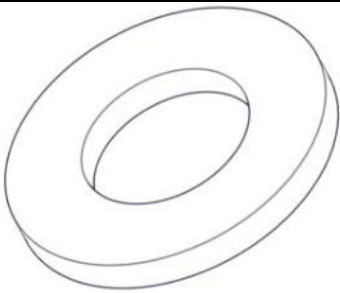
Boltepakker for / Boltpackage for / Bultpaket för		Sign. _____		
Grå- rød 60-164-801	Navn	Artnr/ dimensjon	Ant	Lev
	Stolpe 70x70 L=1000 (400-600) Sort Med hull for hylsemutter	07-530-050	4	
	Sandlekebord rektangel sprosse stotte Grå	07-530-049K (Se egen delmontering)	2	
	Sandlekebord rektangel sprosse lang Grå	07-530-047K (Se egen delmontering)	2	
	Sandlekebord rektangel bonnplate Brun	07-530-041	1	
	Sandlekebord rektangel sprosse kort Grå	07-530-048	2	
	Sandlekebord rektangel topplate Rød	07-530-045	1	

Boltepakker for / Boltpackage for / Bultpaket för		Sign. _____.		
Grå- rød 60-164-801	Navn	Artnr/ dimensjon	Ant	Lev
	Unbrako skrue M8x40 linsehode	04-035-040	4	
	Hylsemutter Ø12x70 1xM8	04-019-070	4	
	Vinkel 35x35x35x3 11mm hull	04-070-036	4	
	Torx M8x12	04-000-012	8	
	Skive M8	04-050-008	8	
	Møbelknapp M8x11	04-030-011	8	

Boltepakker for / Boltpackage for / Bultpaket för

Sign. _____.

Grå- rød 60-164-801	Navn	Artnr/ dimensjon	Ant	Lev
	Produktmerke Montert hos Søve	00-100-400 (montert hos Søve)	0	

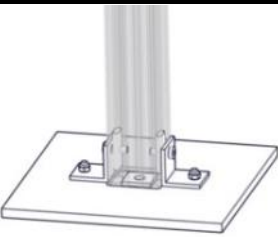
Boltepakker for / Boltpackage for / Bultpaket för		Sign. _____.		
Grå- rød 60-164-801	Navn	Artnr/ dimensjon	Ant	Lev
	Fundament Støp			
	Støpefundament 70 x 70 stolpe	00-003-112K (se egen delmontering)	4	
	Fundament Nedgravning			
	Nedgravningsfundament 70 x 70 stolpe	07-510-207K (se egen delmontering)	4	

Boltepakker for / Boltpackage for / Bultpaket för

Sign. _____.

Grå- rød
60-164-801

Navn

Artnr/dimensjon

Ant

Lev

**Overflate
montering**Fundament 70x70 for
Betongdekke00-003-129K
(se egen
dekemontering)

4

Stolpe kappes

07-530-050

4