

N**Monteringsanvisning****EN****Assembly Instructions****S****Monteringsanvisning**

Produkt nr. / Product no. / Produkt nr.

61-200-341**Steel materia/ Grå**

Ord. nr. _____

Dato. _____

Sign. _____

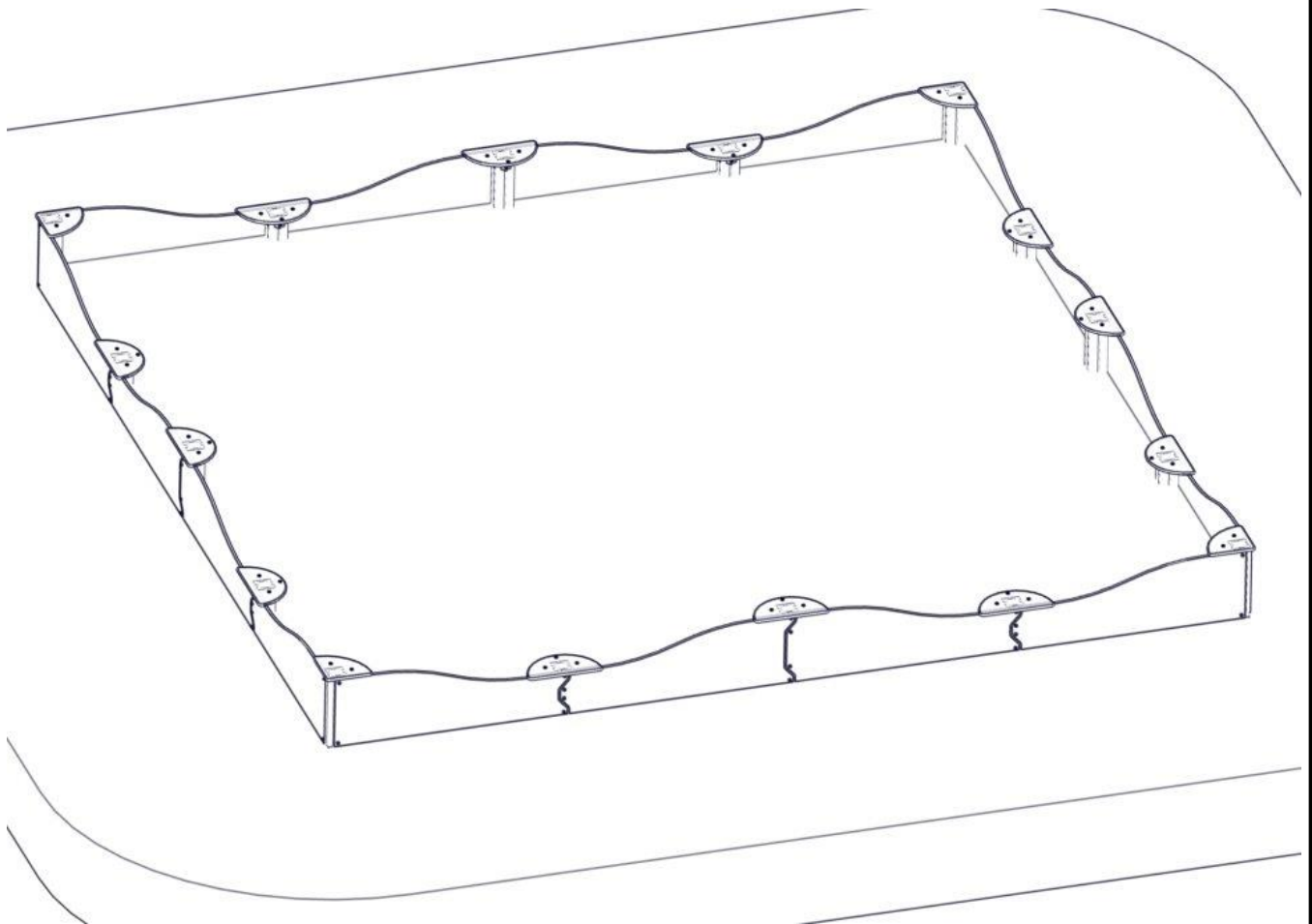
**søve**

Søve AS
Grønnvoldveien 290
3830 Ulefoss - Norway
Tlf: +47 35 94 65 65
www.sove.no

**søve**

Søve AB
EA Rosengrensgatan 32
421 31 Västra Frölunda
Phone: +46 (0)31 773 97 00
www.sove.se

Monteringstips / Assembly Advice / Monteringsstips

N

- Les monteringsanvisningen nøye før montering.
- Monter elementene i rekkefølgen som vist.
- Boltene bør ikke skrues for hardt til før alt er montert, vatret og loddet. Skru så boltene til.
- NB! Ved bruk av drill, kan boltene ryke.
- På grunn av at solen kan gjøre rutsjeflaten veldig varm, bør rutsjebanens utløp vende mot nord-øst eller nord-vest.
- Er lekeutstyret plassert i naturlige ferdselstraséer må området sikres mot gjennomgang.
- Innspringningshinder bør vurderes rundt lekeapparater hvor det er stor bevegelse, f.eks. ved huskestativ.
- Det bør være fritt innsyn til lekeutstyr som er beregnet for barn under 3 år.

NB! Under monteringsarbeidet må utstyr, som ikke er forankret forsvarlig i bakken, sikres slik at det ikke velte.

Området må avstenges under montering av apparatene med sperrebånd eller lignende.

EN

- Read the instruction carefully before assembling the play unit.
- Assemble the components in the sequence shown in these instructions.
Fixings must not be fully tightened during assembly. Before casting the foundations, the structure must be level and plumb, at which point all fixings are tightened.
PS! If use of drill, the bolts may be wrecked.
- Avoid positioning the slide facing due south because of overheating – ideal positions are facing north-east or north-west.
Secure the construction-area to prevent people from walking through it.
- Consider installing barriers around play-equipment which gives rise to a lot of activity – i.e. swings.
- Ensure that clear vision is possible across the play area so that supervision is possible from any position, particularly where children under 3 years of age will be playing.

NB! During assembly of the equipment, ensure that all structures are securely propped, especially when left overnight. Also ensure that equipment is supported

Monteringstips / Assembly Advice / Monteringsstips**S**

- Läs monteringsanvisningen noga före montering.

- Montera delarna i den ordningen som anvisas
- Skruvarna bör inte skruvas för hårt tills allt är monterat, i våg och lodat.







OBS! Används elektrisk skruvdragare, kan bulten gå sönder. Hårdra därför manuellt!

- Solen kan göra att rutchbanan blir väldigt varm. Banans nedfart rekommenderas att vändas i norrlig riktning
- Om lekplatsen placeras vid en gångväg mm bör området säkras mot genomfart av gående och cyklister.
- Insprängningshinder bör placeras runt lekutrustning med stor rörelse, t ex, gungställning.
- Det bör vara fri insyn till lekutrustning beräknat till barn under 3 år.

OBS! Under monteringsarbete bör utrustningen som inte ska förankras i marken, ställs så att den inte kan välta.

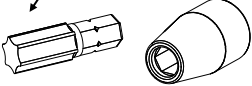
Området måste spärras när lekutrustningen byggs upp, med avspärrningsband eller liknande.

Nødvendig verktøy / Tools required / Nödvändiga verktyg





<p>(N)</p> <p>(EN)</p> <p>(S)</p>	<p>(A)</p> 	<p>(B)</p>  <p>Torx Nr 45</p>	<p>(C)</p> <p>5 mm 6 mm</p> 	<p>(D)</p> 	<p>(E)</p>
		<p>Metermål</p> <p>Metric measure</p> <p>Tumstock</p> 		<p>Merkebånd</p> <p>Mark ribbon</p> <p>Märkeband</p> 	

Nødvendig antall personer / Number of persons required / Rekommenderad antal personer

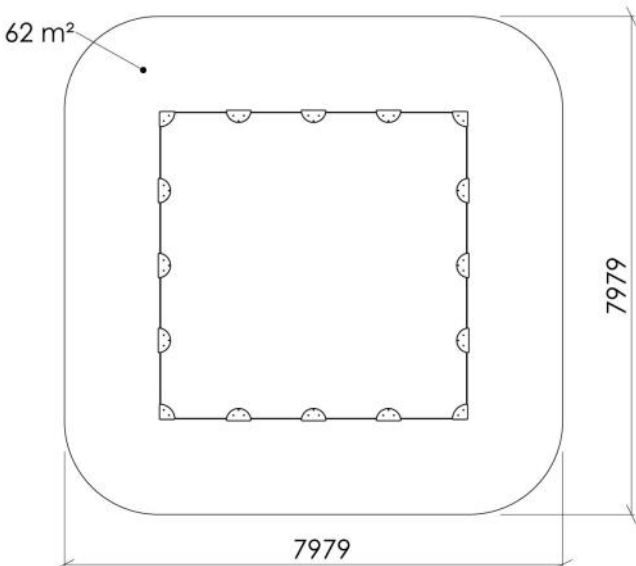
<p>(N)</p> <p>(EN)</p> <p>(S)</p>	
-----------------------------------	---

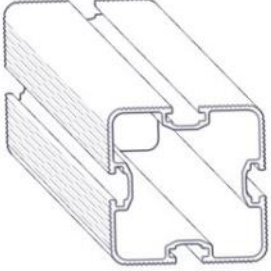

Anbefalt arealbehov ved montering / Recommended working space / Rekommenderad arealbehov vid montering

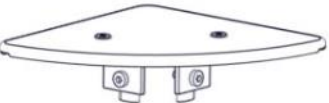
<p>(N)</p> <p>(EN)</p> <p>(S)</p>	
-----------------------------------	--

Boltepakker for / Boltpackage for / Bultpaket för		Sign. _____		
Sandkasse 4,9 x 4,9 61-200-341	Navn	Artnr/ dimensjon	Ant	Lev
	Stolpe 95 x 95 400-250 L= 650 Sort	SFA5117/1	8	
	Stolpe 95 x 95 400-400 L= 800 Sort	SFA5117/1	8	
	Vegg 400 rett/ 250 female 1250 x 250/400 Steel Materia	06-200-221K (se egen del- montering)	4	
	Vegg 250 male/ 400 rett 1250 x 250/400 Steel Materia	06-200-220K (se egen del- montering)	4	
	Vegg 400 male/ 250 female 1250 x 250/400 Steel Materia	06-200-225K (se egen del- montering)	4	
	Vegg 250 male/ 400 female 1250 x 250/400 Steel Materia	06-200-224K (se egen del- montering)	4	
	Seteplate 90 grader Grå	06-200-312K (se egen del- montering)	4	

Boltepakker for / Boltpackage for / Bultpaket för

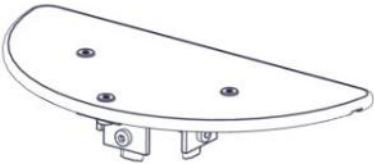
Sign. _____.

Sandkasse 4,9 x 4,9 61-200-341	Navn	Artnr/ dimensjon	Ant	Lev
	Seteplate 180 grader Grå	06-200-322K (se egen del- montering)	12	
	Produktmerke	00-100-400 (montert hos Søve)	0	

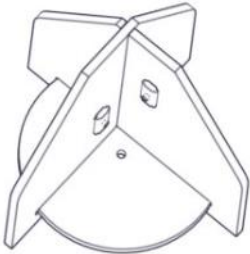
Boltepakker for / Boltpackage for / Bultpaket för		Sign. _____.		
Sandkasse 4,9 x 4,9 61-200-341	Navn	Artnr/ dimensjon	Ant	Lev
	Fundament Støp			
	Fundament Nedgravning			
	Nedgravningsfundament 95 x 95 stolpe	00-003-004K (se egen del- montering)	16	

Fundamentering uten betong / Foundation without concrete / Förankring utan betong

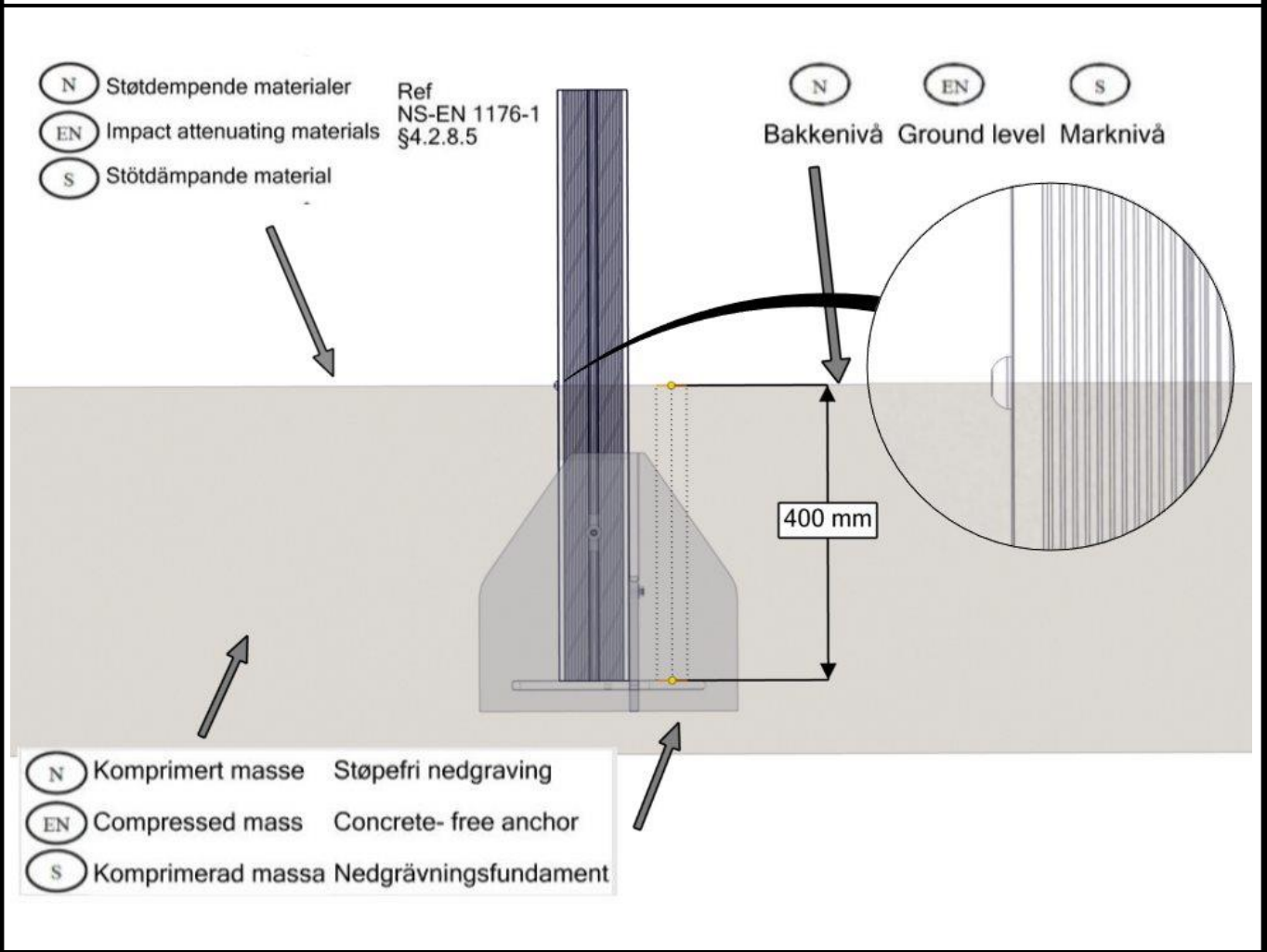

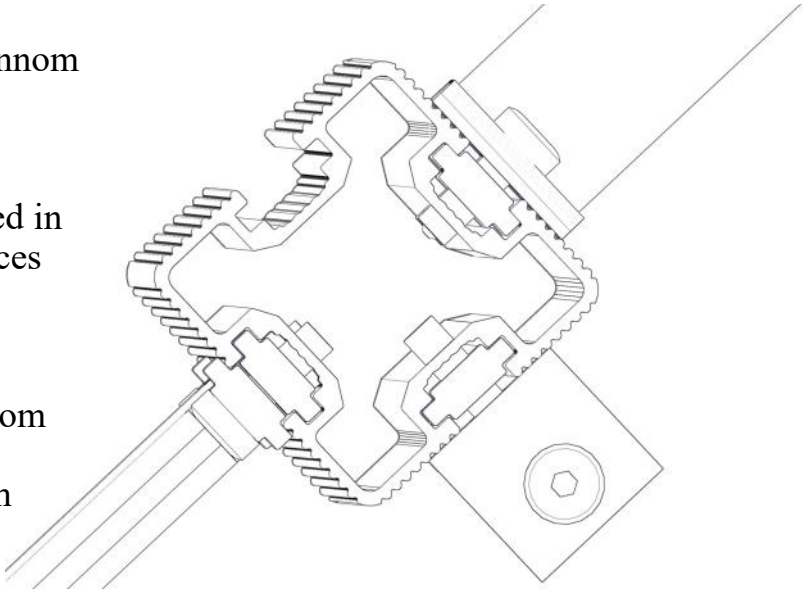
<p>(N) Bolten skrues HELT igjennom aluminiumen. Maks moment: 30Nm</p> <p>(EN) The bolt must be tightened in to the post, so that it peirces the aluminium Max torque: 30Nm</p> <p>(S) Bulten skuvas HELT genom aluminiumen. Maks vridmoment: 30Nm</p>				
NO	Betongkvalitet			
SE	Betongkvalitet			
EN	Concrete quality			
NO	Mengde betong			
SE	Mängd betong			
EN	Amount of concrete			
NO	Fundament størrelse			
SE	Stiftelsestorlek			
EN	Foundation size			
NO	For sikkerhet må fundamentene med sand eller myk jord være minst 50% større i areal			
SE	För säkerheten måste grunden med sand eller mjuk jord vara minst 50% större i området			
EN	For safety, the foundations with sand or soft soil must be at least 50% larger in area			
NO	Tyngste element	06-200-221	6,7	Kg
SE	Tyngsta element			
EN	Heaviest element			
NO	Største element	06-200-221	1,25 x 0,4 x 0,012	m
SE	Största element			
EN	Biggest element			

Fallhøyder / Free height of fall / Fallhöjder

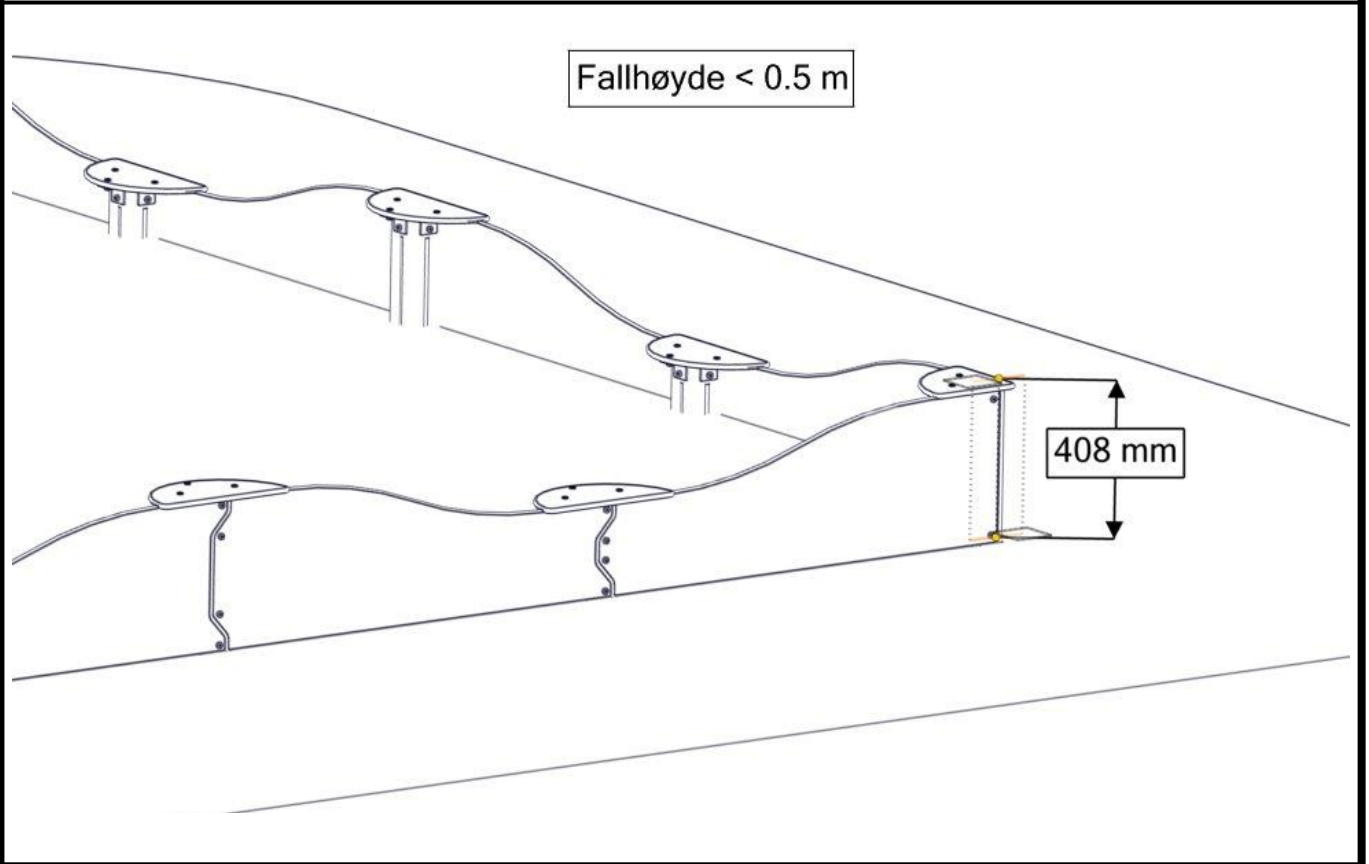

Sikkerhetszone / Safety zone / Säkerhetszon

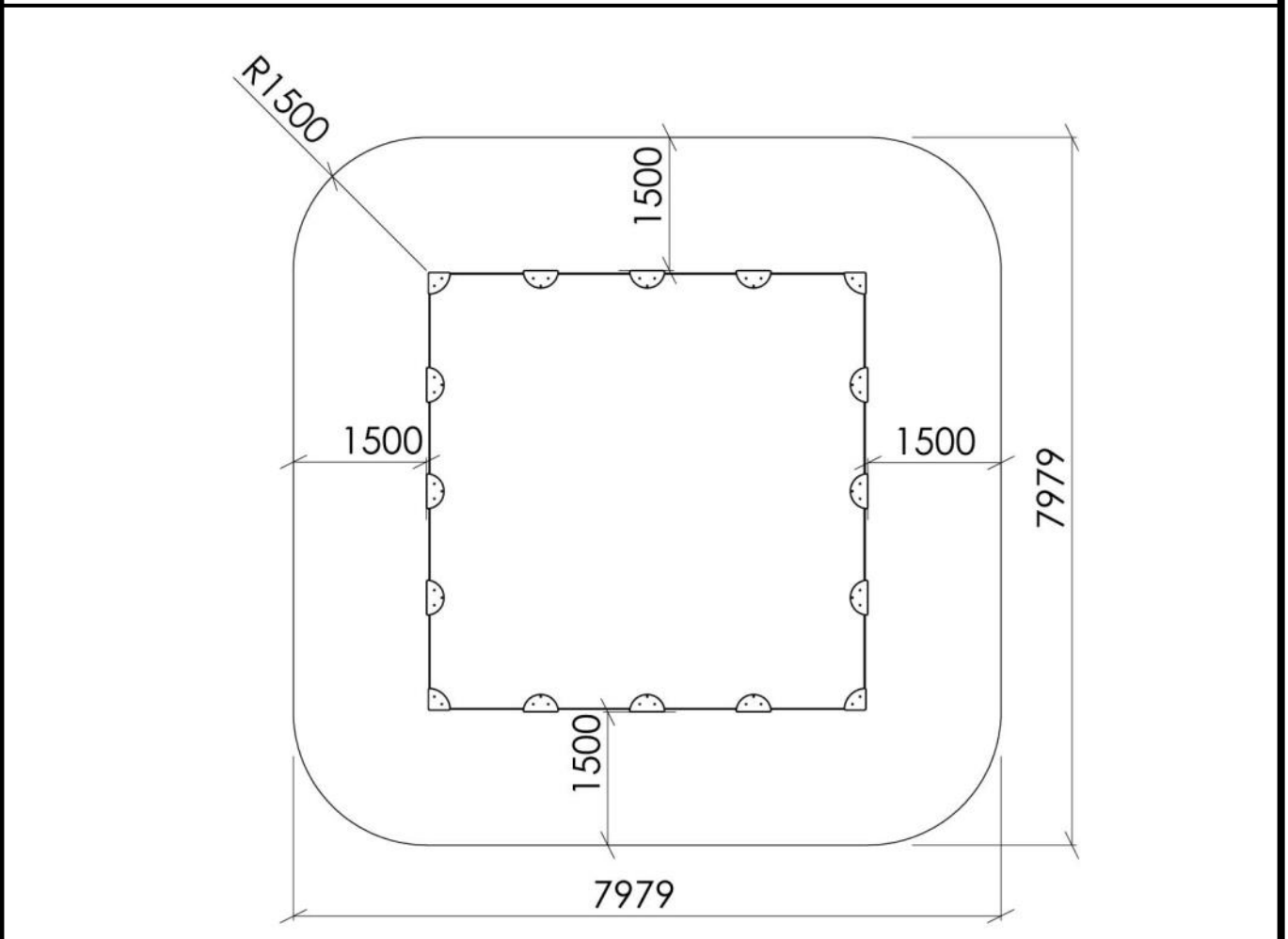

Plassering av forankringer / Ground plan / Placering av förankringar

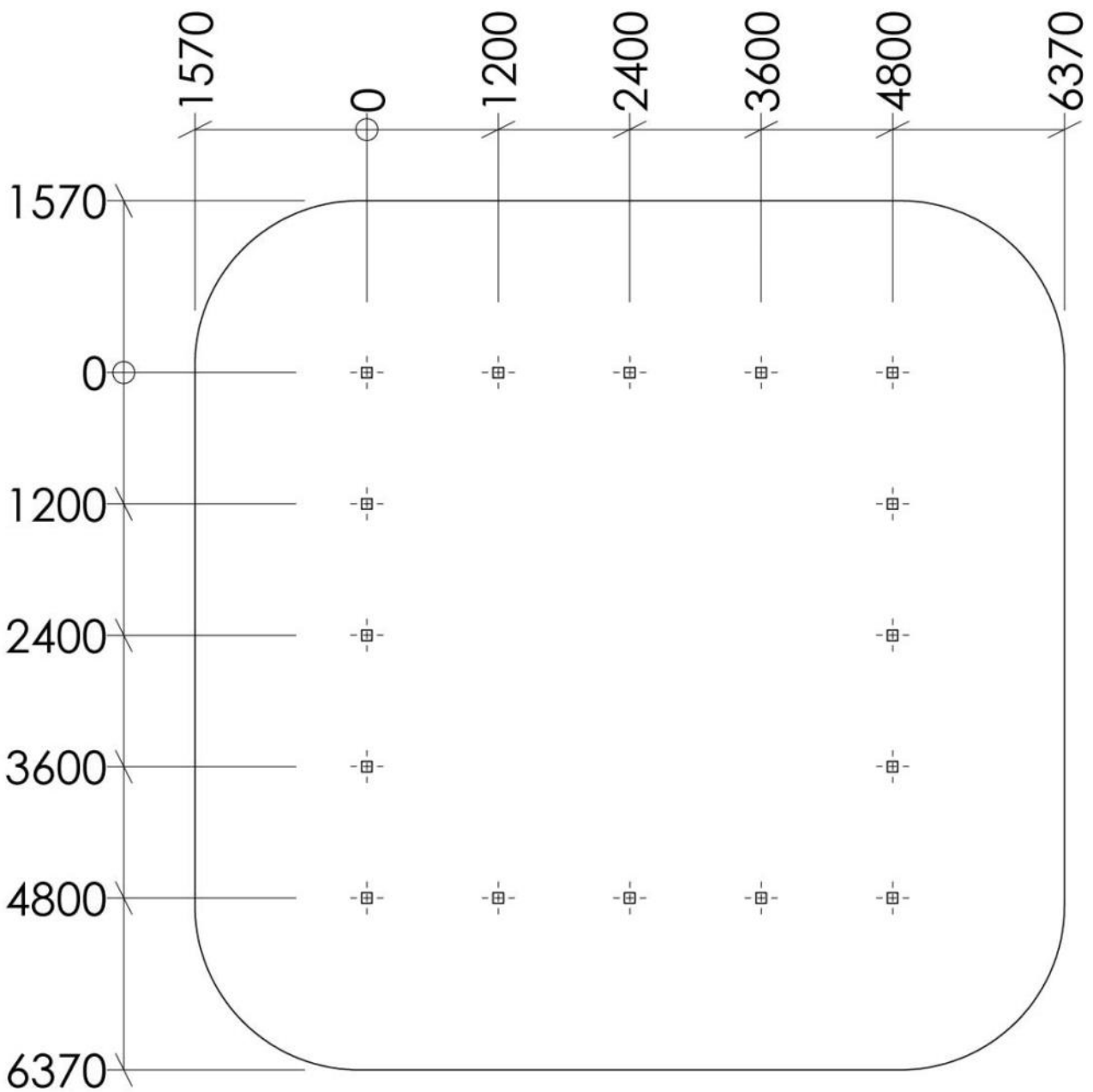

(N)

Alle mål er oppgitt i millimeter

(EN)

Scale measured in mm

(S)

Alla mått är i millimeter.

Montering av lekeapparatet / Assembly instructions / Montering av lekredskapet

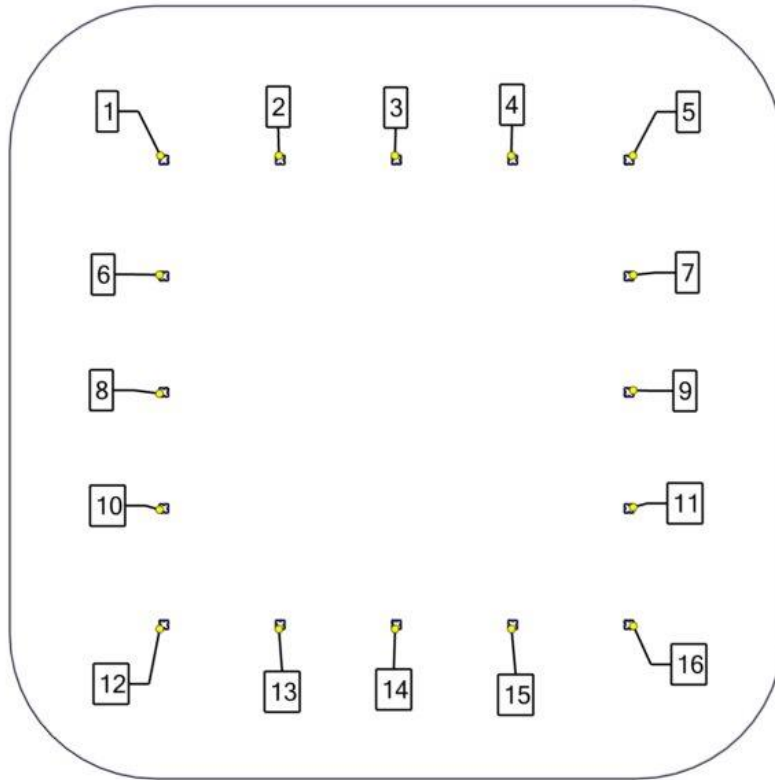

Se separat delmontering for detaljer
 See separate assembly for details
 Se separata delmontering för detaljer

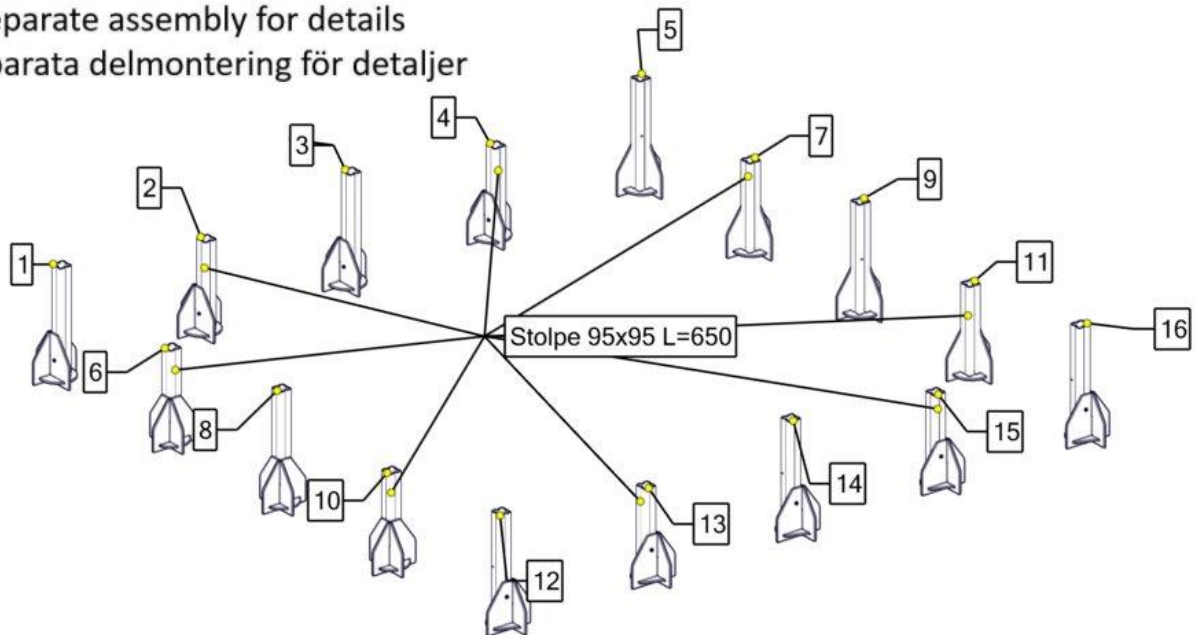

Part Name	Article nr.	Qty
Nedgravingsfundament 95x95	00-003-004K	16
Stolpe 95x95 L=650	SFA5117/1	8
Stolpe 95x95 L=800	SFA5117/1	8

Montering av lekeapparatet / Assembly instructions / Montering av lekredskapet

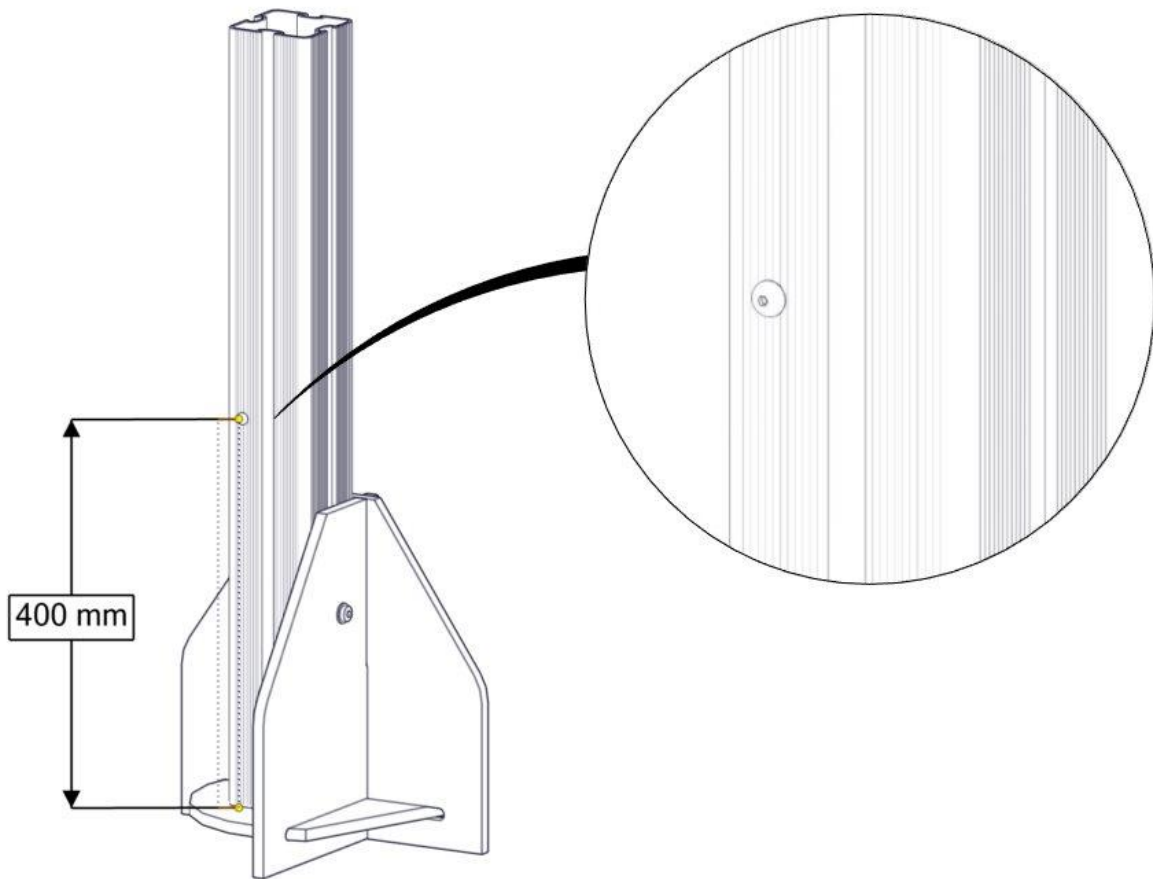

Se separat delmontering for detaljer
 See separate assembly for details
 Se separata delmontering för detaljer

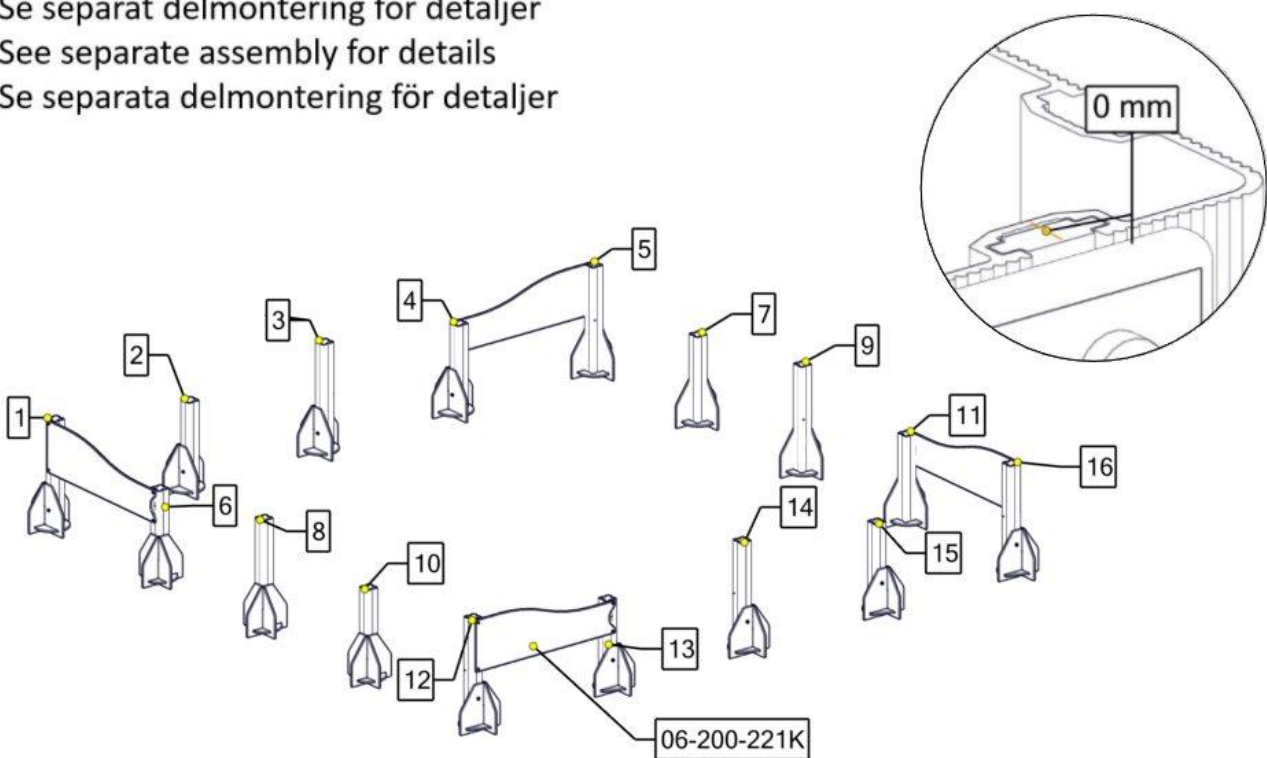

Part Name	Article nr.	Qty
Vegg 400Rett 250 Female	06-200-221K	4

Montering av lekeapparatet / Assembly instructions / Montering av lekredskapet

Se separat delmontering for detaljer
 See separate assembly for details
 Se separata delmontering för detaljer

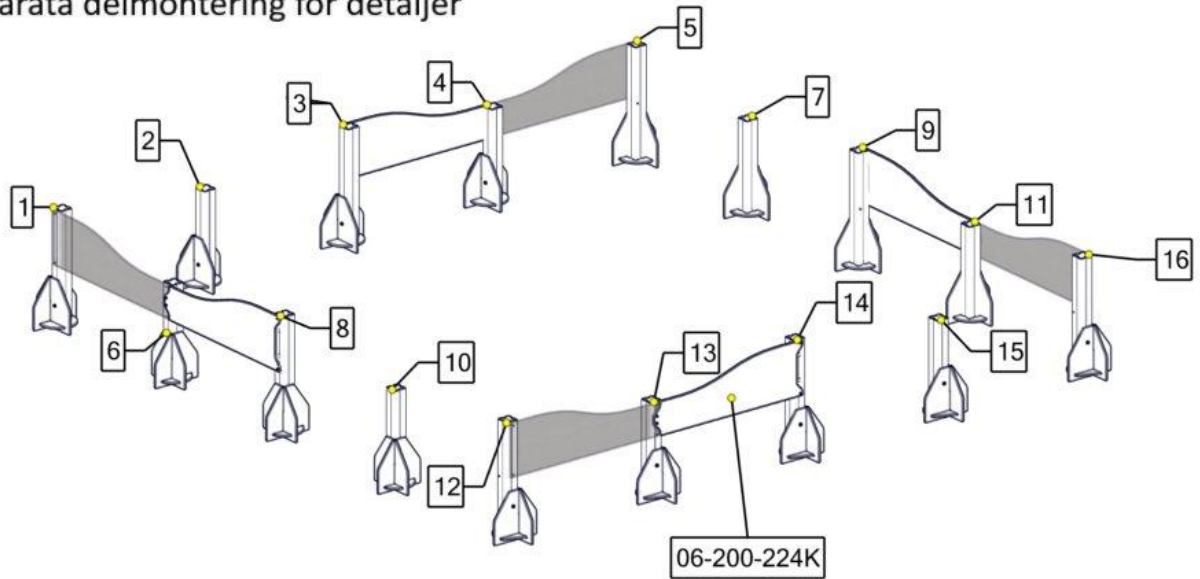

Part Name	Article nr.	Qty
Vegg 250Male 400Female	06-200-224K	4

Se separat delmontering for detaljer
 See separate assembly for details
 Se separata delmontering för detaljer

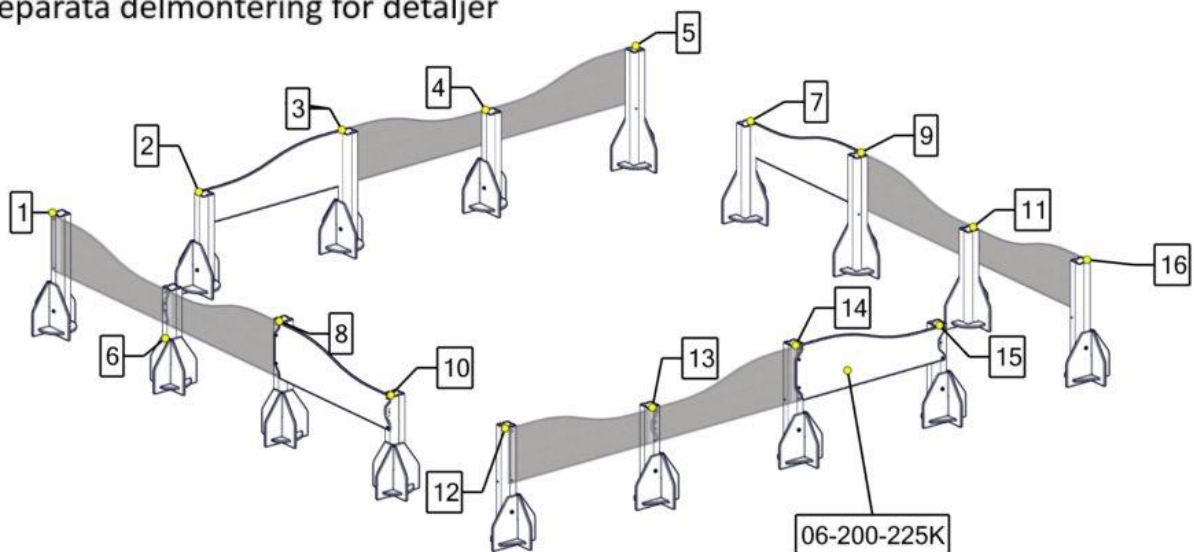

Part Name	Article nr.	Qty
Vegg 400Male 250Female	06-200-225K	4

Montering av lekeapparatet / Assembly instructions / Montering av lekredskapet

Se separat delmontering for detaljer
 See separate assembly for details
 Se separata delmontering för detaljer

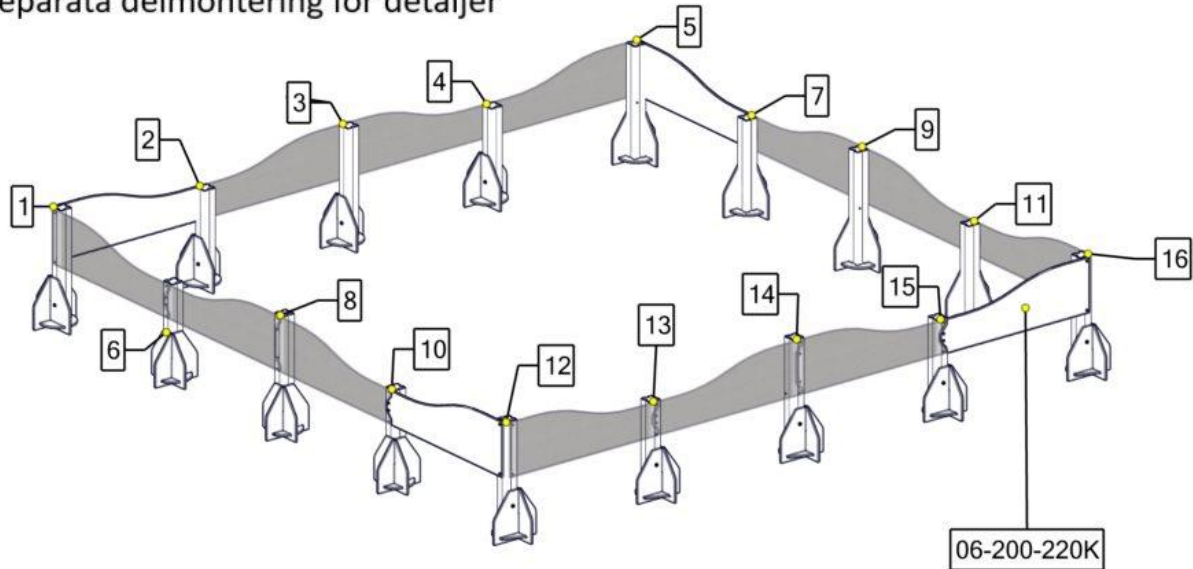



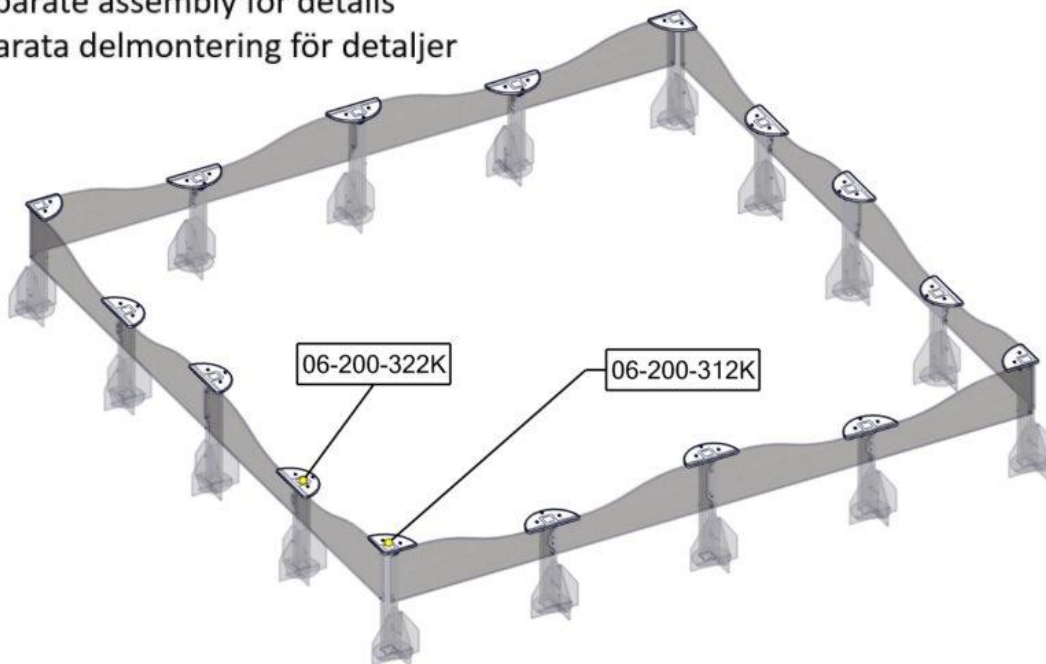

Part Name	Article nr.	Qty
Vegg 250Male 400Rett	06-200-220K	4



Se separat delmontering for detaljer
 See separate assembly for details
 Se separata delmontering för detaljer

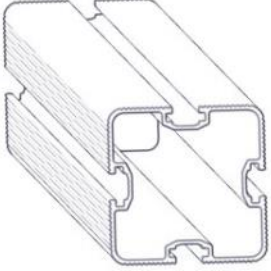

Part Name	Article nr.	Qty
Seteplate 90 grader	06-200-312K	4
Seteplate 180 grader	06-200-322K	12

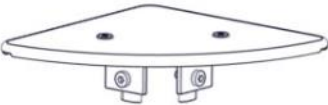
Før utstyret tas i bruk / Before play begins / Innan lekredskapet tas i bruk	
N	<ul style="list-style-type: none"> ● Påse at fallunderlag er utlagt i henhold til gjeldende regler eller vår anbefaling ● Fjern alle monteringshjelpemidler (rester av betong, planker, paller, plast, og lignende) ● Før utstyret tas i bruk, burde man sjekke at det ikke er fare for at anorakksnorer og lignende som kan hekte seg fast noen steder på lekeapparatet. (Vedlagte snor med dobbe (kneledd) kan brukes til å sjekke at dette er i orden. Se vedlagte veiledning for bruk av denne. Dette gjøres for å oppdage eventuelle feilmonteringer.?) ● NB! Bør stå i 2-3 dager før bruk
EN	<ul style="list-style-type: none"> ● Make sure the area and depth of safer surfacing are according to the current standard, or to the manufacturer's recommendation ● Make sure all tools and surplus materials are removed before play begins ● PS! When complete, allow 2-3 days for the concrete to set before use
S	<ul style="list-style-type: none"> ● Kontrollera att fallunderlag är utlagt enligt gällande regler eller vårt rekommendation ● Ta bort alla monteringshjälpmedel (rester av betong, plankor, pallar, plast och liknande) ● Innan lekredskapet används, kontrollera att anoracksnoddar eller kläder/delar av kläder eller liknande inte kan fastna i några delar på redskapet. (Den bipackade "knävringen" kan man med fördel användas för denna kontroll. ● Detta görs för att upptäcka eventuella felmonteringar.)

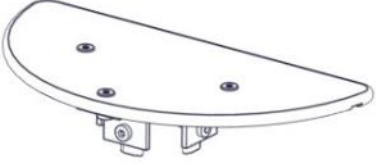
Boltepakker for / Boltpackage for / Bultpaket för		Sign. _____		
Sandkasse 4,9 x 4,9 61-200-341	Navn	Artnr/ dimensjon	Ant	Lev
	Stolpe 95 x 95 400-250 L= 650 Sort	SFA5117/1	8	
	Stolpe 95 x 95 400-400 L= 800 Sort	SFA5117/1	8	
	Vegg 400 rett/ 250 female 1250 x 250/400 Steel Materia	06-200-221K (se egen del- montering)	4	
	Vegg 250 male/ 400 rett 1250 x 250/400 Steel Materia	06-200-220K (se egen del- montering)	4	
	Vegg 400 male/ 250 female 1250 x 250/400 Steel Materia	06-200-225K (se egen del- montering)	4	
	Vegg 250 male/ 400 female 1250 x 250/400 Steel Materia	06-200-224K (se egen del- montering)	4	
	Seteplate 90 grader Grå	06-200-312K (se egen del- montering)	4	

Boltepakker for / Boltpackage for / Bultpaket för		Sign. _____.		
Sandkasse 4,9 x 4,9 61-200-341	Navn	Artnr/ dimensjon	Ant	Lev
	Seteplate 180 grader Grå	06-200-322K (se egen del- montering)	12	
	Produktmerke	00-100-400 (montert hos Søve)	0	

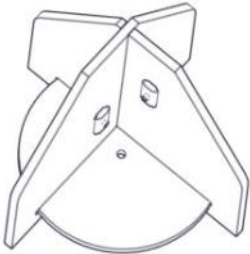
Boltepakker for / Boltpackage for / Bultpaket för		Sign. _____.		
Sandkasse 4,9 x 4,9 61-200-341	Navn	Artnr/ dimensjon	Ant	Lev
	Fundament Støp			
	Fundament Nedgravning			
	Nedgravningsfundament 95 x 95 stolpe	00-003-004K (se egen del- montering)	16	