

N**Monteringsanvisning****EN****Assembly Instructions****S****Monteringsanvisning**

Produkt nr. / Product no. / Produkt nr.

66-001-040**Grå / Gul**

Ordr. nr. _____

Dato. _____

Sign. _____

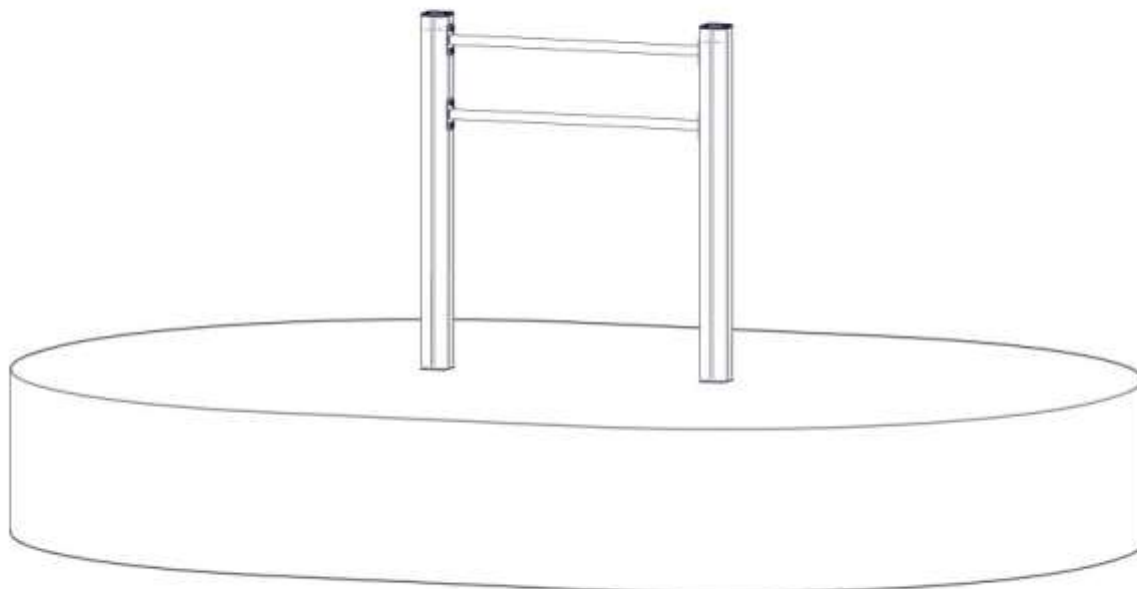
**søve**

Søve AS
Grønnvoldveien 290
3830 Ulefoss - Norway
Tlf: +47 35 94 65 65
www.sove.no

**søve**

Søve AB
EA Rosengrensgatan 32
421 31 Västra Frölunda
Phone: +46 (0)31 773 97 00
www.sove.se

Monteringstips / Assembly Advice / Monteringsstips

N

- Les monteringsanvisningen nøye før montering.
- Monter elementene i rekkefølgen som vist.
- Boltene bør ikke skrues for hardt til før alt er montert, vatret og loddet. Skru så boltene til.
- NB! Ved bruk av drill, kan boltene ryke.
- På grunn av at solen kan gjøre rutsjeplaten veldig varm, bør rutsjebanens utløp vende mot nord-øst eller nord-vest.
- Er lekeutstyret plassert i naturlige ferdselstraséer må området sikres mot gjennomgang.
- Innspringningshinder bør vurderes rundt lekeapparater hvor det er stor bevegelse, f.eks. ved huskestativ.
- Det bør være fritt innsyn til lekeutstyr som er beregnet for barn under 3 år.

NB! Under monteringsarbeidet må utstyr, som ikke er forankret forsvarlig i bakken, sikres slik at det ikke velte.

Området må avstenges under montering av apparatene med sperrebånd eller lignende.

EN

- Read the instruction carefully before assembling the play unit.
- Assemble the components in the sequence shown in these instructions.
Fixings must not be fully tightened during assembly. Before casting the foundations, the structure must be level and plumb, at which point all fixings are tightened.
PS! If use of drill, the bolts may be wrecked.
- Avoid positioning the slide facing due south because of overheating – ideal positions are facing north-east or north-west.
Secure the construction-area to prevent people from walking through it.
- Consider installing barriers around play-equipment which gives rise to a lot of activity – i.e. swings.
- Ensure that clear vision is possible across the play area so that supervision is possible from any position, particularly where children under 3 years of age will be playing.

NB! During assembly of the equipment, ensure that all structures are securely propped, especially when left overnight. Also ensure that equipment is supported

Monteringstips / Assembly Advice / Monteringsstips

S

- Läs monteringsanvisningen noga före montering.
- Montera delarna i den ordningen som anvisas
- Skruvarna bör inte skruvas för hårt tills allt är monterat, i våg och lodat.

OBS! Används elektrisk skruvdragare, kan bulten gå sönder. Hårdra därför manuellt!

- Om lekplatsen placeras vid en gångväg mm bör området säkras mot genomfart av gående och cyklister.
- Insprängningshinder bör placeras runt lekutrustning med stor rörelse, t ex, gungställning.
- Det bör vara fri insyn till lekutrustning beräknat till barn under 3 år.







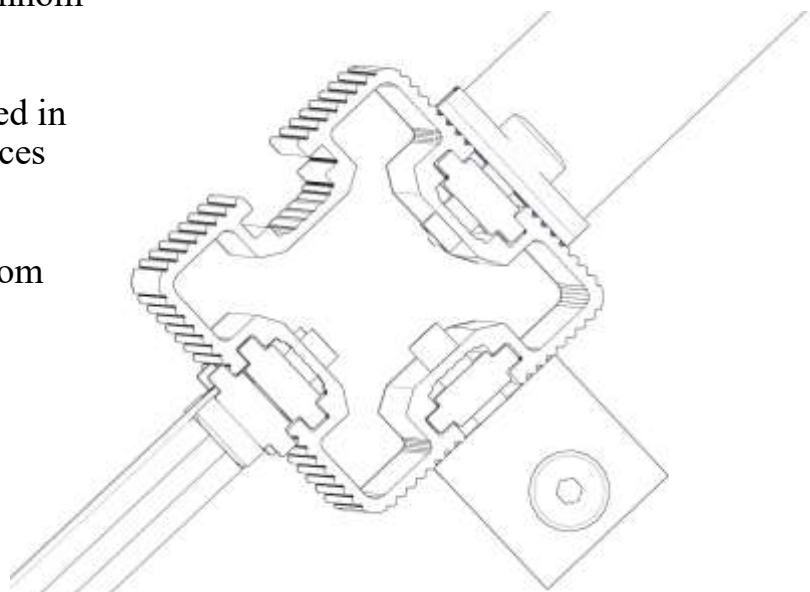

OBS! Under monteringsarbete bör utrustningen som inte ska förankras i marken, ställs så att den inte kan välta.

Området måste spärras när lekutrustningen byggs upp, med avspärrningsband eller liknande.

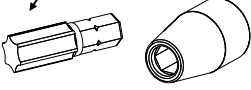
NO	Betongkvalitet	C25/30		
SE	Betongkvalitet			
EN	Concrete quality			
NO	Mengde betong	0,2	m ³	
SE	Mängd betong			
EN	Amount of concrete			
NO	Fundament størrelse	0,5 x 0,5 x 0,4	m	
SE	Stiftelsestorlek			
EN	Foundation size			
NO	For sikkerhet må fundamentene med sand eller myk jord være minst 50% større i areal			
SE	För säkerheten måste grunden med sand eller mjuk jord vara minst 50% större i området			
EN	For safety, the foundations with sand or soft soil must be at least 50% larger in area			
NO	Tyngste element	SFA5117/2	6,3	Kg
SE	Tyngsta element			
EN	Heaviest element			
NO	Største element	SFA5117/2	1,9x0,095x0,095	m
SE	Största element			
EN	Biggest element			
(N)	Bolten skrues HELT igjennom aluminiumen.			
(EN)	The bolt must be tightened in to the post, so that it pierces the aluminium			
(S)	Bulten skruvas HELT igjennom aluminiumen.			
(N)	Alle mål er oppgitt i millimeter			
(EN)	Scale measured in mm			
(S)	Alla mått är i millimeter.			



Nødvendig verktøy / Tools required / Nödvändiga verktyg

<p>(N)</p> <p>(EN)</p> <p>(S)</p>	<p>(A)</p> 	<p>(B)</p>  <p>Torx Nr 45 High quality</p> 	<p>(C)</p>	<p>(D)</p> 	
		<p>Metermål</p> <p>Metric measure</p> <p>Tumstock</p> 	<p>16 V</p> 	<p>Merkebånd</p> <p>Mark ribbon</p> <p>Märkeband</p> 	

Nødvendig antall personer / Number of persons required / Rekommenderad antal personer



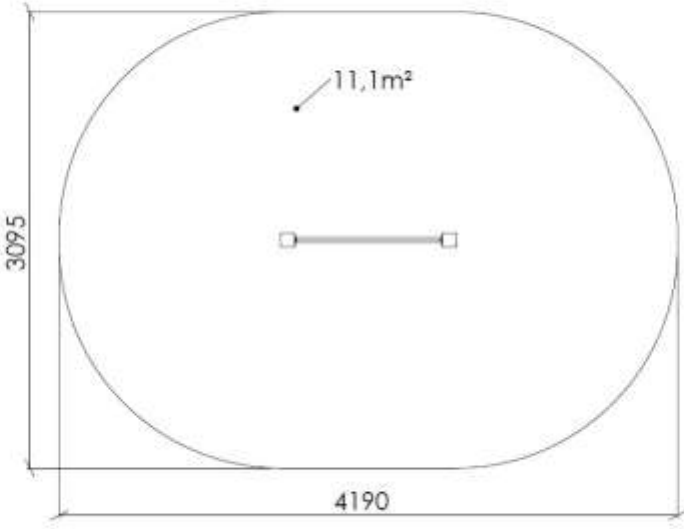

<p>(N)</p> <p>(EN)</p> <p>(S)</p>	
-----------------------------------	---

Anbefalt arealbehov ved montering / Recommended working space / Rekommenderad arealbehov vid montering

<p>(N)</p> <p>(EN)</p> <p>(S)</p>	
-----------------------------------	--

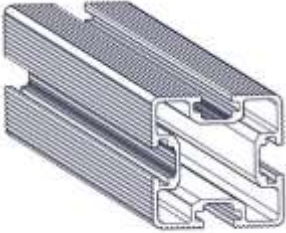

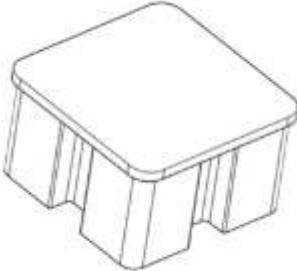
Boltepakker for / Boltpackage for / Bultpaket för

Sign. _____

Pull up Lav 66-001-040	Navn	Artnr/dimensjon	Ant	Lev
	Stolpe 95x95 L=1900 600-1300 Grå	SFA5117/2	2	
	Rekkverk L=1000 Ø33 Gul	07-200-157K (Se egen del- montering)	2	
	Endelokk 95x95	00-400-998	2	
	Produktmerke	00-100-401 (Montert hos Søve)	0	

Boltepakker for / Boltpackage for / Bultpaket för

Sign. _____.

Pull up Lav 66-001-040	Navn	Artnr/dimensjon	Ant	Lev
	Fundament Støp			
	Fundament støp 95x95 stolpe	00-003-110K (Se egen del- montering)	2	
	Overflate- montering			
	Overflatemontering 95x95 stolpe forsterket	00-003-136K (se egen del- montering)	2	
	Stolpe kappes	SFA5117	2	

Fundamentering med betong / Foundation concrete / Förankring med betong

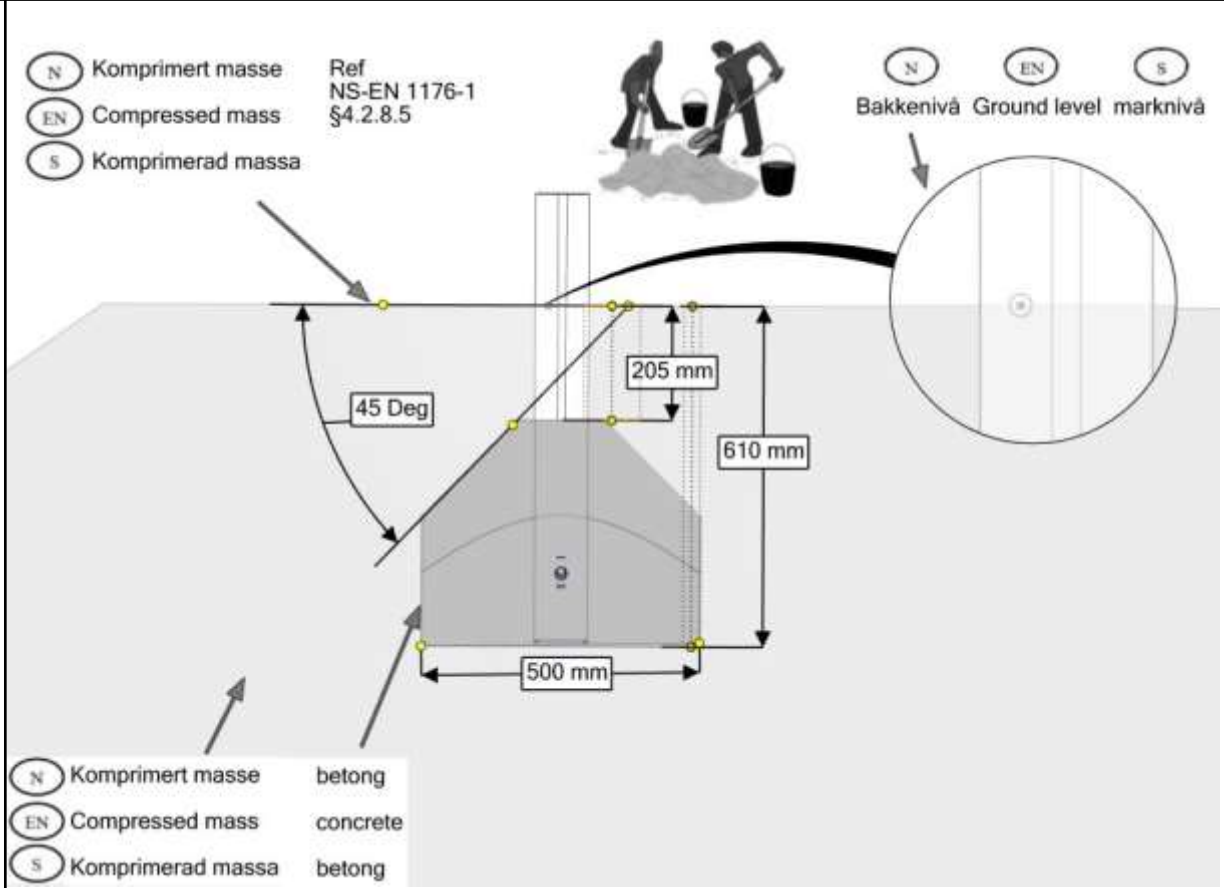

Overflatemontering / Surface mounting / Ytmontering

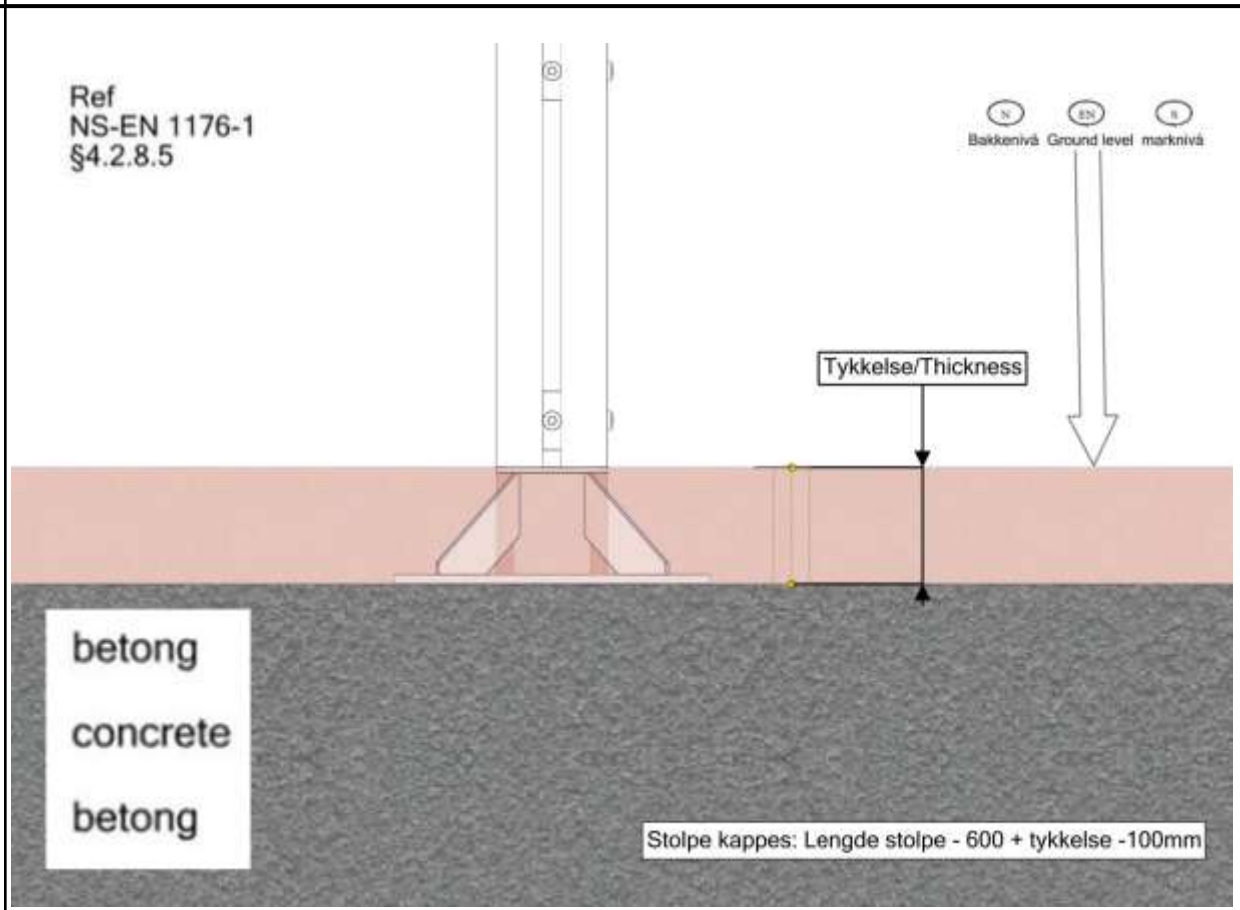

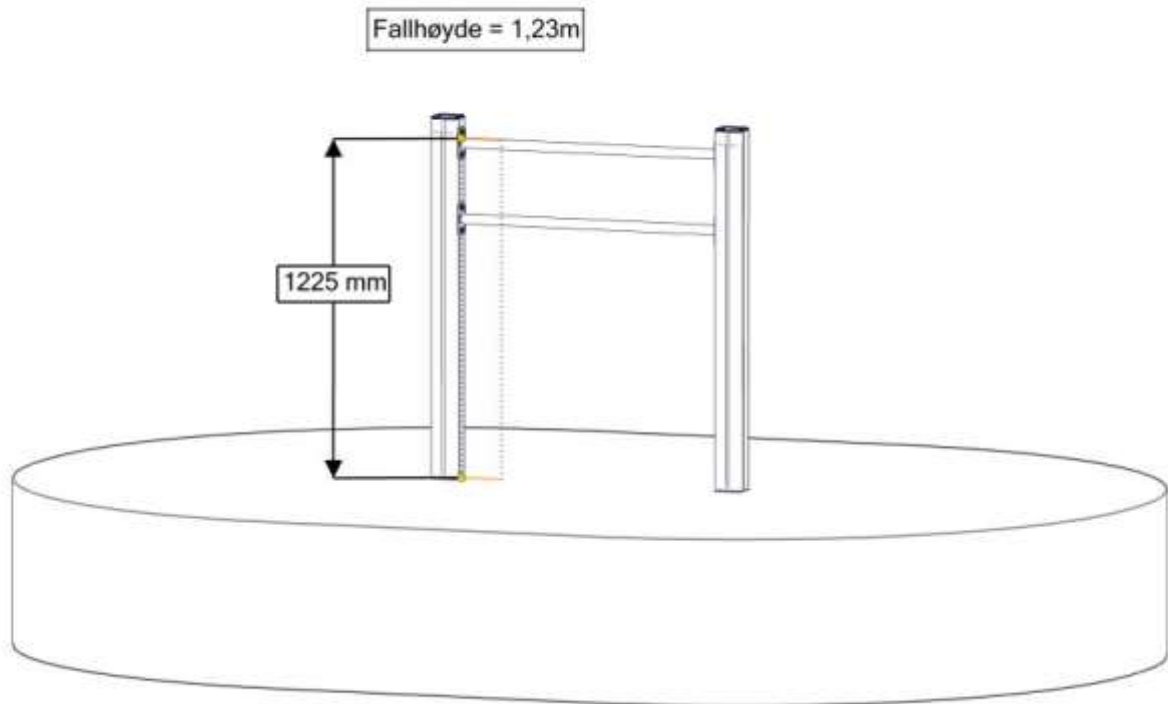
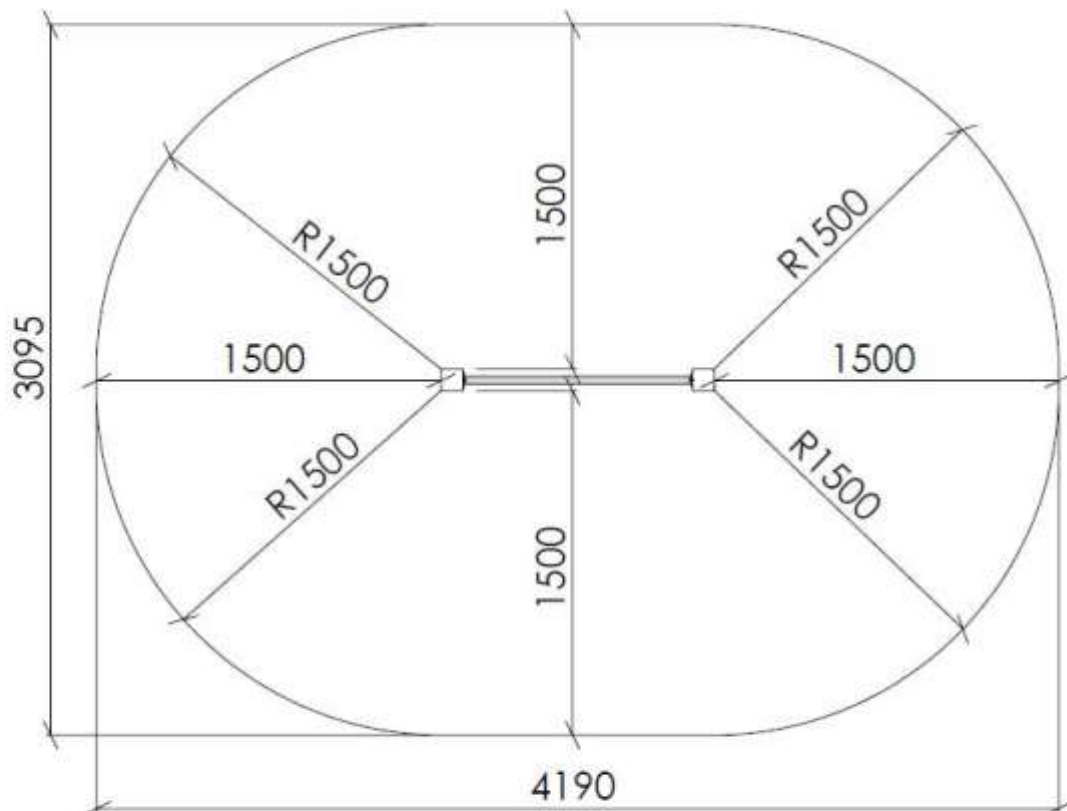
Fallhøyder / Free height of fall / Fallhöjder**Sikkerhetszone / Safety zone / Säkerhetszon**

Plassering av forankringer / Ground plan / Placering av förankringar

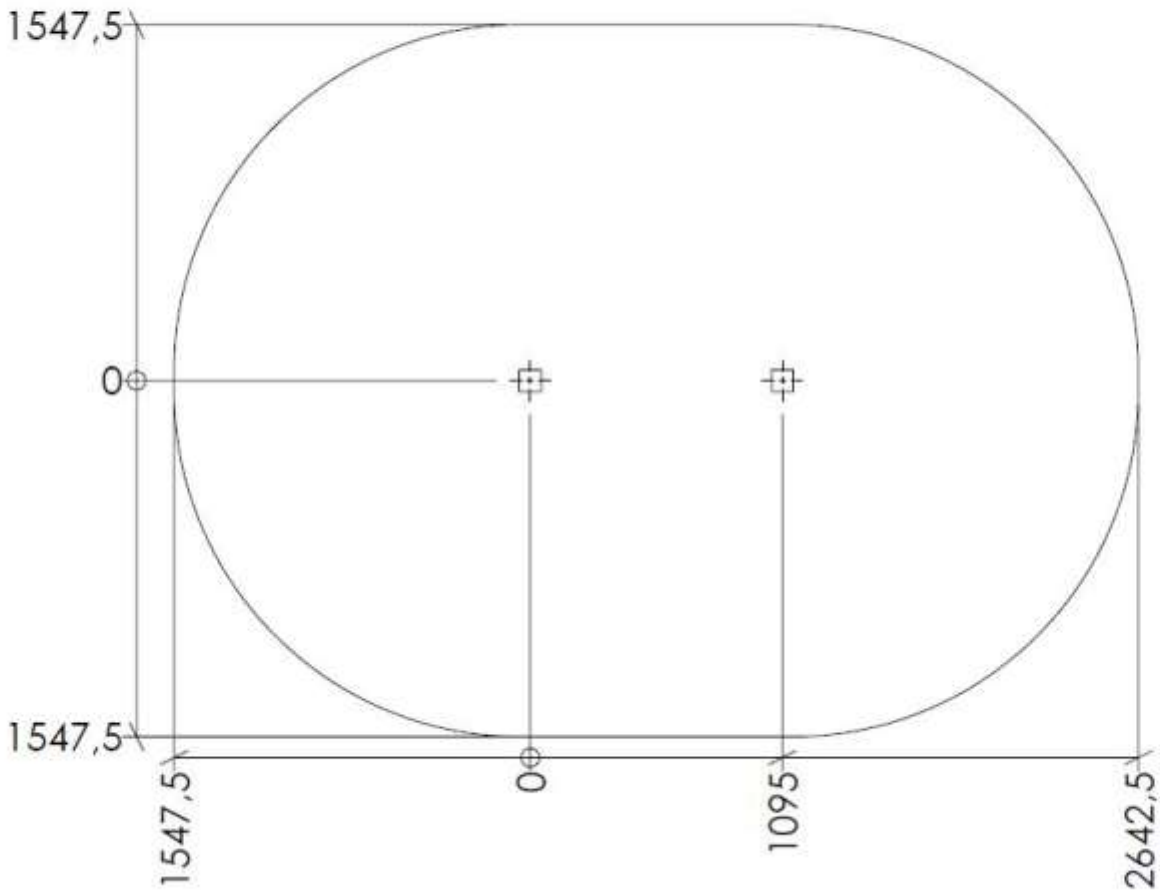

Montering av lekeapparatet / Assembly instructions / Montering av lekredskapet

Se separat delmontering for detaljer
 See separate assembly for details
 Se separata delmontering för detaljer

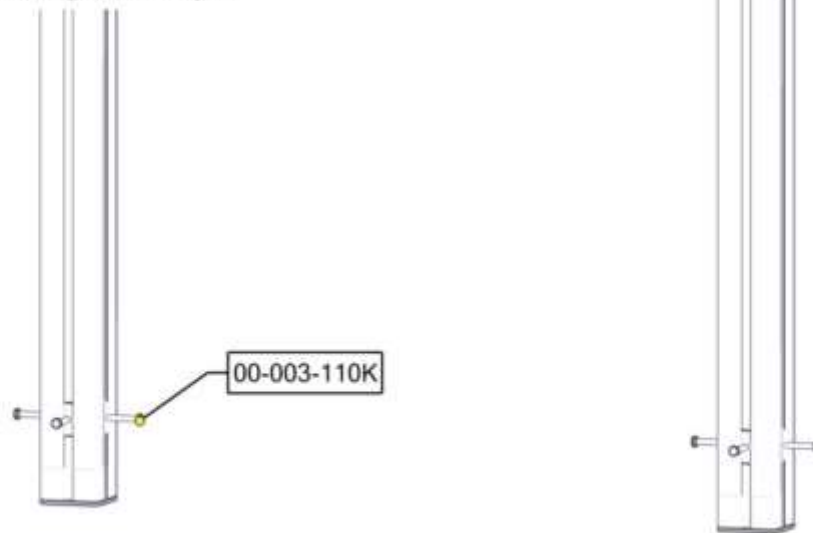

Part Name	Article nr.	Qty
Fundament til støp 95x95 stolpe	00-003-110K	2

Se separat delmontering for detaljer
 See separate assembly for details
 Se separata delmontering för detaljer

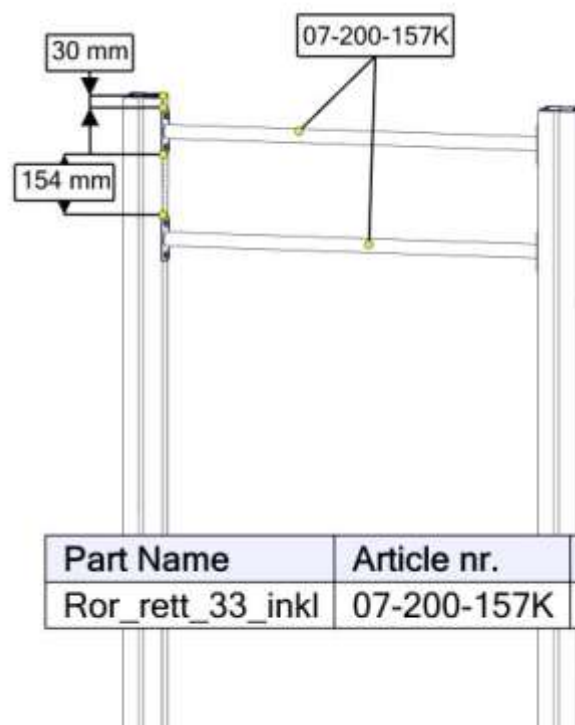

Part Name	Article nr.	Qty
Ror_rett_33_inkl	07-200-157K	2

Montering av lekeapparatet / Assembly instructions / Montering av lekredskapet



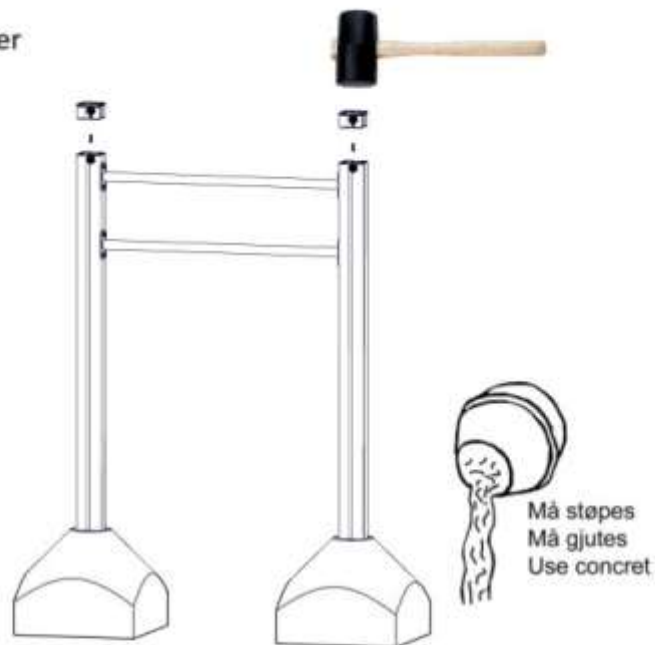

Se separat delmontering for detaljer
See separate assembly for details
Se separata delmontering för detaljer



Part Name	Article nr.	Qty
Endelokk 95x95	00-400-998	2

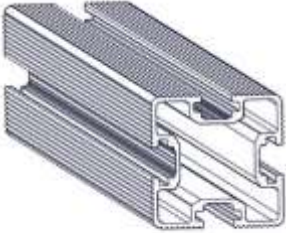

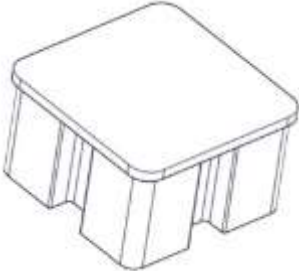
Boltepakker for / Boltpackage for / Bultpaket för

Sign. _____

Pull up Lav 66-001-040	Navn	Artnr/dimensjon	Ant	Lev
	Stolpe 95x95 L=1900 600-1300 Grå	SFA5117/2	2	
	Rekkverk L=1000 Ø33 Gul	07-200-157K (Se egen del- montering)	2	
	Endelokk 95x95	00-400-998	2	
	Produktmerke	00-100-401 (Montert hos Søve)	0	

Boltepakker for / Boltpackage for / Bultpaket för

Sign. _____.

Pull up Lav 66-001-040	Navn	Artnr/dimensjon	Ant	Lev
	Fundament Støp			
	Fundament støp 95x95 stolpe	00-003-110K (Se egen del- montering)	2	
	Overflate- montering			
	Overflatemontering 95x95 stolpe forsterket	00-003-136K (se egen del- montering)	2	
	Stolpe kappes	SFA5117	2	

11-06-2021 SV
Lagt til et rekkverk

07-10-2022
Overflatemontering
MNO