

N

**Monteringsanvisning**

EN

**Assembly Instructions**

S

**Monteringsanvisning**

Produkt nr. / Product no. / Produkt nr.

**70-870-025**

Ordr. nr. \_\_\_\_\_

Dato. \_\_\_\_\_

Sign. \_\_\_\_\_

Nett må bestilles separat  
Nets must be ordered separately

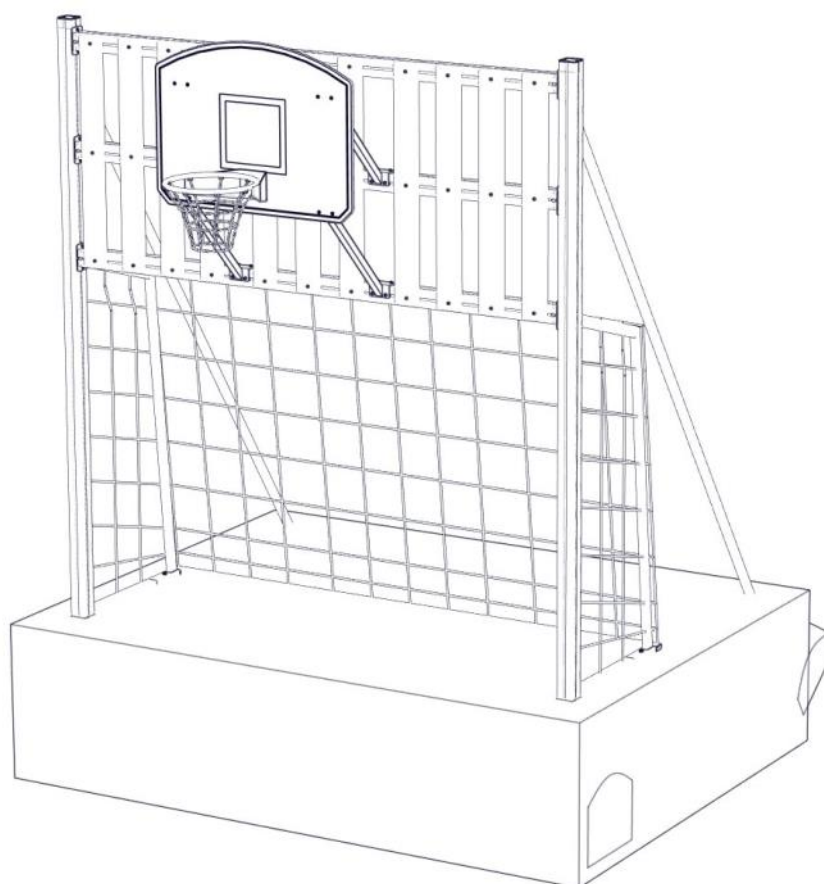

Søve AS  
Grønnvoldveien 290  
3830 Ulefoss - Norway  
Tlf: +47 35 94 65 65  
[www.sove.no](http://www.sove.no)



Søve AB  
EA Rosengrensgatan 32  
421 31 Västra Frölunda  
Phone: +46 (0)31 773 97 00  
[www.sove.se](http://www.sove.se)

## Monteringstips / Assembly Advice / Monteringsstips

N

- Les monteringsanvisningen nøye før montering.
- Monter elementene i rekkefølgen som vist.
- Boltene bør ikke skrues for hardt til før alt er montert, vatret og loddet. Skru så boltene til.
- NB! Ved bruk av drill, kan boltene ryke.
- På grunn av at solen kan gjøre rutsjeflaten veldig varm, bør rutsjebanens utløp vende mot nord-øst eller nord-vest.
- Er lekeutstyret plassert i naturlige ferdselstraséer må området sikres mot gjennomgang.
- Innspringningshinder bør vurderes rundt lekeapparater hvor det er stor bevegelse, f.eks. ved huskestativ.
- Det bør være fritt innsyn til lekeutstyr som er beregnet for barn under 3 år.

**NB! Under monteringsarbeidet må utstyr, som ikke er forankret forsvarlig i bakken, sikres slik at det ikke velte.**

**Området må avstenges under montering av apparatene med sperrebånd eller lignende.**

EN

- Read the instruction carefully before assembling the play unit.
- Assemble the components in the sequence shown in these instructions.  
Fixings must not be fully tightened during assembly. Before casting the foundations, the structure must be level and plumb, at which point all fixings are tightened.  
PS! If use of drill, the bolts may be wrecked.
- Avoid positioning the slide facing due south because of overheating – ideal positions are facing north-east or north-west.  
Secure the construction-area to prevent people from walking through it.
- Consider installing barriers around play-equipment which gives rise to a lot of activity – i.e. swings.
- Ensure that clear vision is possible across the play area so that supervision is possible from any position, particularly where children under 3 years of age will be playing.

**NB! During assembly of the equipment, ensure that all structures are securely propped, especially when left overnight. Also ensure that equipment is supported**

**Monteringstips / Assembly Advice / Monteringsstips****S**

- Läs monteringsanvisningen noga före montering.

- Montera delarna i den ordningen som anvisas
- Skruvarna bör inte skruvas för hårt tills allt är monterat, i våg och lodat.

OBS! Används elektrisk skruvdragare, kan bulten gå sönder. Hårdra därför manuellt!











- Solen kan göra att rutchbanan blir väldigt varm. Banans nedfart rekommenderas att vändas i norrlig riktning
- Om lekplatsen placeras vid en gångväg mm bör området säkras mot genomfart av gående och cyklister.
- Insprängningshinder bör placeras runt lekutrustning med stor rörelse, t ex, gungställning.
- Det bör vara fri insyn till lekutrustning beräknat till barn under 3 år.

**OBS! Under monteringsarbete bör utrustningen som inte ska förankras i marken, ställs så att den inte kan välta.**

**Området måste spärras när lekutrustningen byggs upp, med avspärrningsband eller liknande.**

NO	Betongkvalitet	C25/30			
SE	Betongkvalitet				
EN	Concrete quality				
NO	Mengde betong		0,4	m <sup>3</sup>	
SE	Mängd betong				
EN	Amount of concrete				
NO	Fundament størrelse		0,5x0,5x0,4	m	
SE	Stiftelsestorlek				
EN	Foundation size				
NO	For sikkerhet må fundamentene med sand eller myk jord være minst 50% større i areal				
SE	För säkerheten måste grunden med sand eller mjuk jord vara minst 50% större i området				
EN	For safety, the foundations with sand or soft soil must be at least 50% larger in area				
NO	Tyngste element	SFA5117/1	13,6	Kg	
SE	Tyngsta element				
EN	Heaviest element				
NO	Største element	00-450-862 00-853-000	4,51x0,12x0,12 2,11x0,91x0,06	m	
SE	Största element				
EN	Biggest element				

**Nødvendig verktøy / Tools required / Nödvändiga verktyg**

<p>(N)</p> <p>(EN)</p> <p>(S)</p>	<p>(A)</p> 	<p>(B)</p>  <p>Torx Nr 45 High quality</p>	<p>(C)</p> <p>5 mm 6 mm</p> 	<p>(D)</p> 	<p>(E)</p> 
		<p>Metermål Metric measure Tumstoc</p> 	<p>16 V</p> 	<p>Merkebånd Mark ribbon Märkeband</p> 	<p>13 + 17mm</p> 

**Nødvendig antall personer / Number of persons required / Lämpligt antal personer**





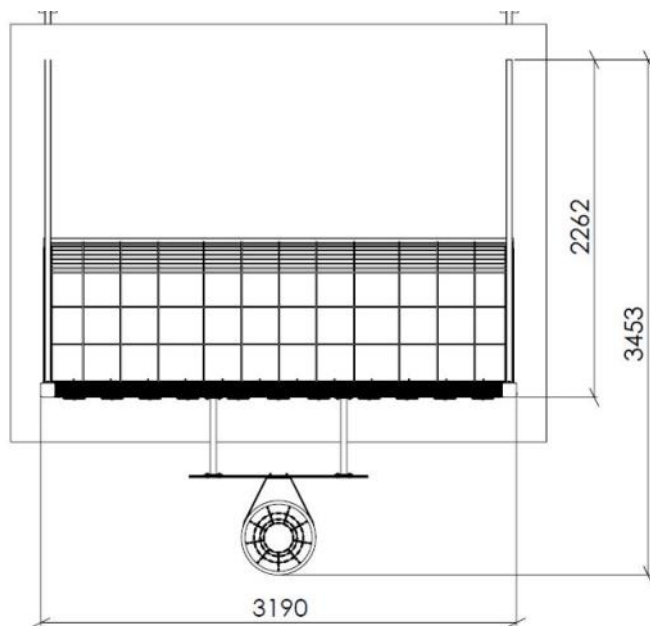

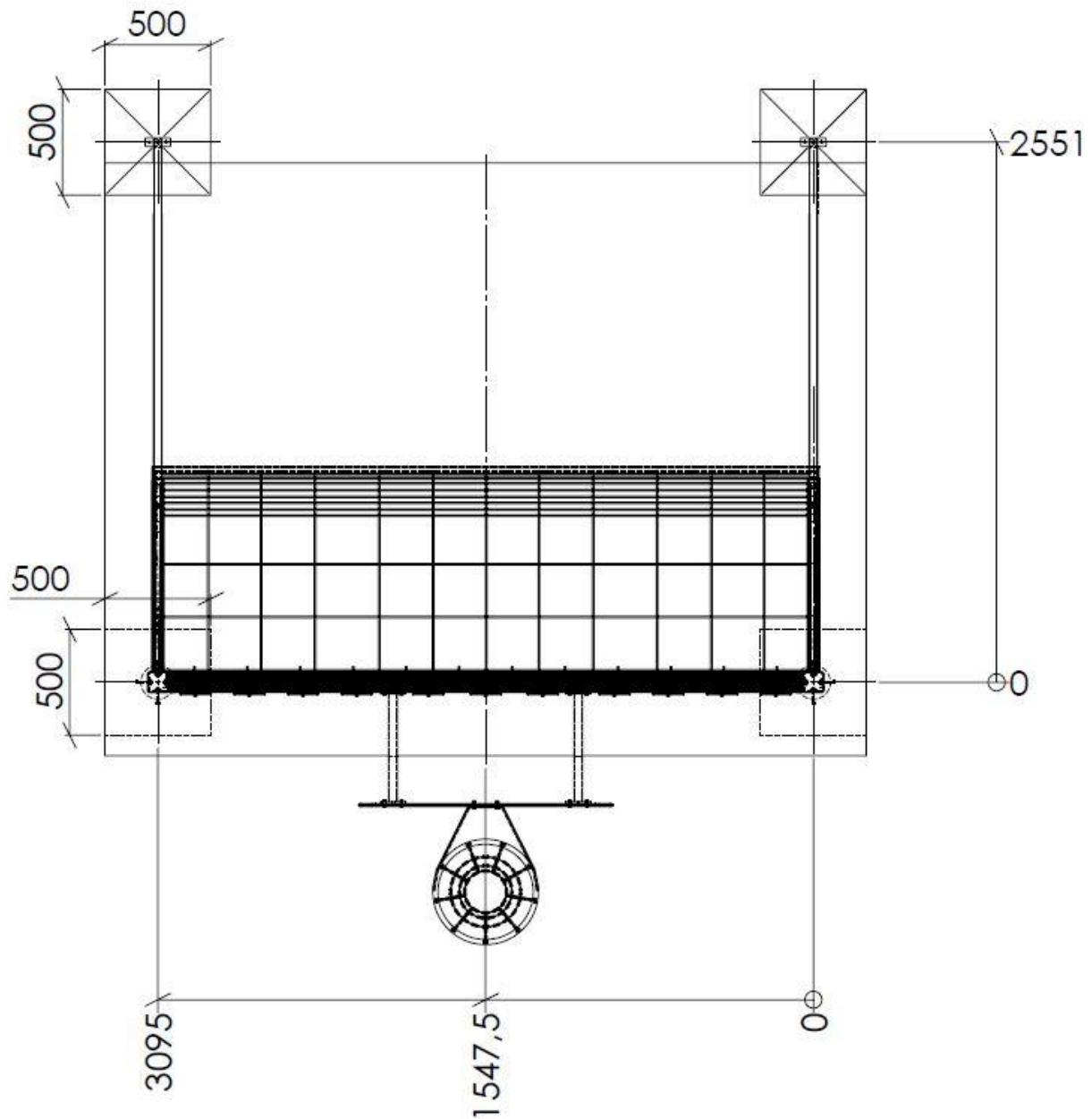
**Anbefalt arealbehov ved montering / Recommended working space / Rekommenderad arealbehov vid montering**



**Plassering av forankringer / Ground plan / Placering av förankringar**

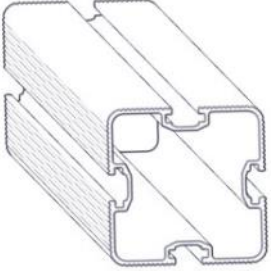

**Boltepakker for / Boltpackage for / Bultpaket för**

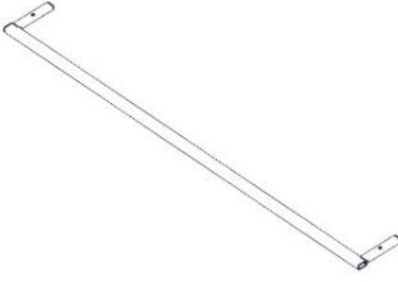
Sign. \_\_\_\_\_

Mål med basketballkurv 70-870-025	Navn	Artnr/ dimensjon	Ant	Lev
	Stolpe 95x95 Lengde = 4180 (800-3380) Sort	SFA5117/1	2	
	Drager sprosser 95x95 L=3000 Sort	07-200-001	1	
	Drager Nett-Basket sprosser 95x95 L=3000 Sort	07-200-002	1	
	Drager basket og sprosser 95x95 L=3000 Sort	07-200-003	1	
	Bøyle til skolemål	00-853-000	2	
	Markkryper til skolemål	00-851-010	1	

**Boltepakker for / Boltpackage for / Bultpaket för**

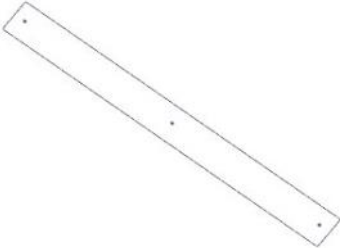
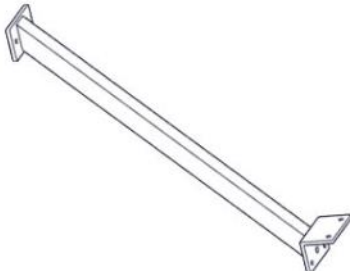

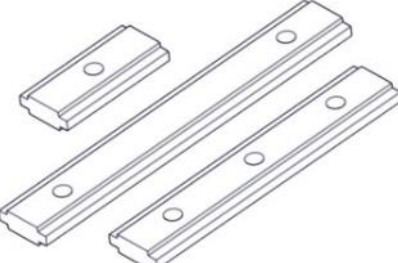
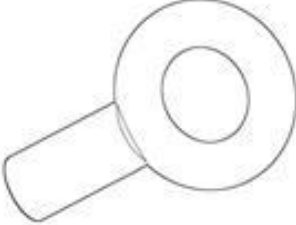
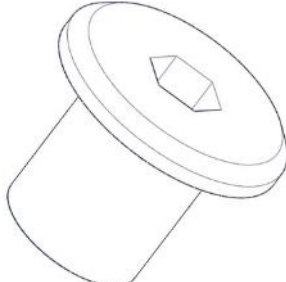

Sign. \_\_\_\_\_

Mål med basketballkurv 70-870-025	Navn	Artnr/ dimensjon	Ant	Lev
	Ballbinge– spiler høy element	01-870-013	11	
	Stag basketballplate ballvegg	01-870-028	4	
	Torx M8x20 Torx M8x30 Torx M8x25 Torx M8x35	04-000-020 04-000-030 04-000-025 04-000-035	8 22 16 37	
	Brikke 50 1xM8 Brikke 120 3xM8 Brikke 160 3xM8	04-060-050 04-060-120 04-060-160	16 2 8	
	Øyebolt M8x20	04-009-020	26	
	Møbelknapp M8x11	04-030-011	8	



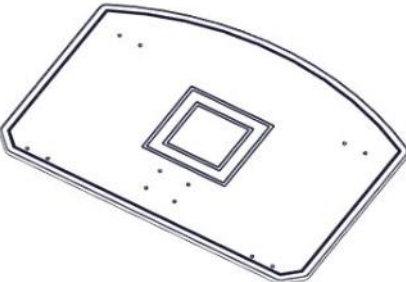

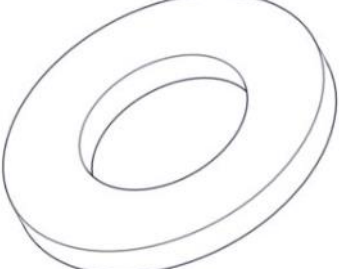
**Boltepakker for / Boltpackage for / Bultpaket för**

Sign. \_\_\_\_\_

Mål med basketballkurv 70-870-025	Navn	Artnr/ dimensjon	Ant	Lev
	Basketballkurv m/nett/kjetting -rustfri	70-865-000	1	
	Basketball plate For vegg montering	70-865-011	1	
	Bolt M10x55 Sekskant	04-010-055	2	
	Låsemutter M10 Låsemutter M8	04-040-010 04-040-008	2 4	
	Skive M8 Skive M10 Stor	04-050-008 04-055-010	54 4	
	Merkeskilt	00-100-400 (Montert hos Søve)	0	

**Boltepakker for / Boltpackage for / Bultpaket för**

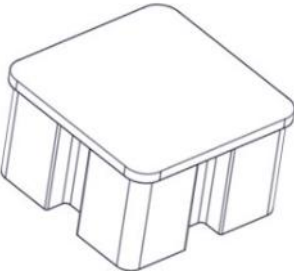
Sign. \_\_\_\_\_.

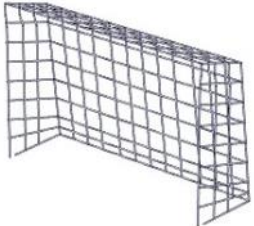
Mål med basketballkurv 70-870-025	Navn	Artnr/ dimensjon	Ant	Lev
	Endelokk 95x95 Sort	00-400-998	2	
	Stag ballvegg skrå (70-870-010/025) over mål L=4,8 meter	00-450-862	2	
	Nett 200x300cm Grønt (Kan kjøpes hos Søve)	70-850-100	0	

**Boltepakker for / Boltpackage for / Bultpaket för**

Sign. \_\_\_\_\_.

Mål med basketballkurv 70-870-025	Navn	Artnr/ dimensjon	Ant	Lev
	<b>Fundament Støp</b>			
	Støpefundament 95 x 95 stolpe	00-003-110K (Se egen Delmontering)	2	

**Fundamentering med betong / Foundation concrete / Förankring med betong**

(N) Støtdempende materialer

(EN) Impact attenuating materials

(S) Støtdämpande material Ref NS-EN 1176-1 §4.2.8.5

(N) (EN) (S) Bakkenivå Ground level Marknivå

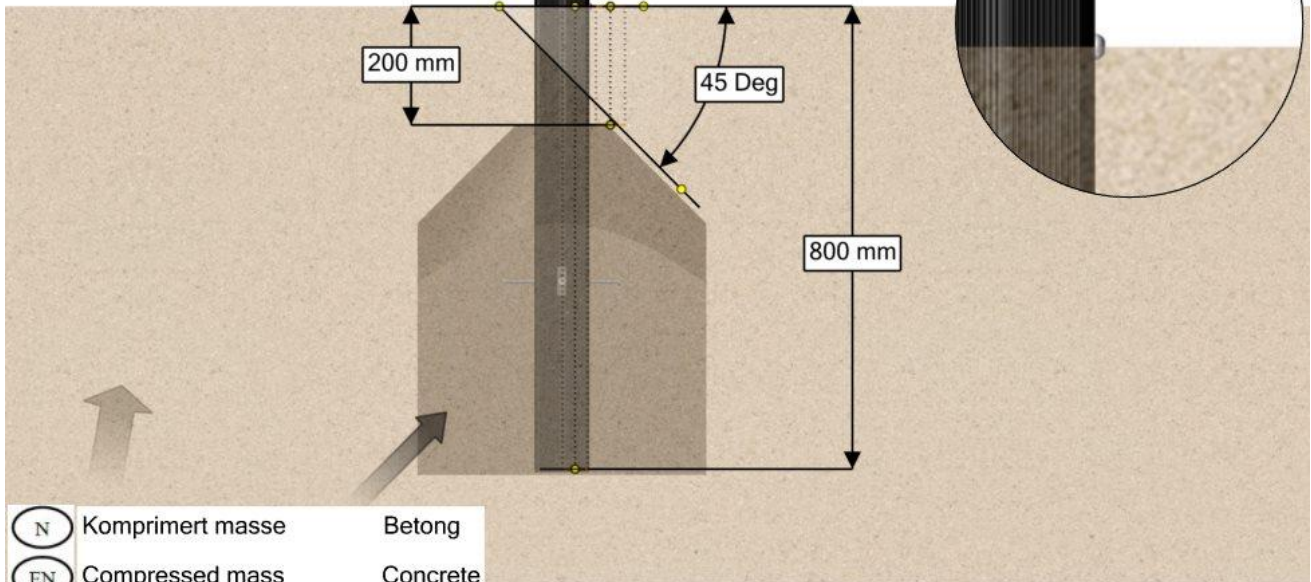

(N) Komprimert masse Betong

(EN) Compressed mass Concrete

(S) Komprimerad massa Betong

(N) Bolten skrues HELT igjennom aluminiumen.  
Maks moment: 30Nm

(EN) The bolt must be tightened in to the post, so that it pierces the aluminium  
Max torque: 30Nm

(S) Bulten skruvas HELT genom aluminiumen.  
Maks Vridmoment: 30Nm

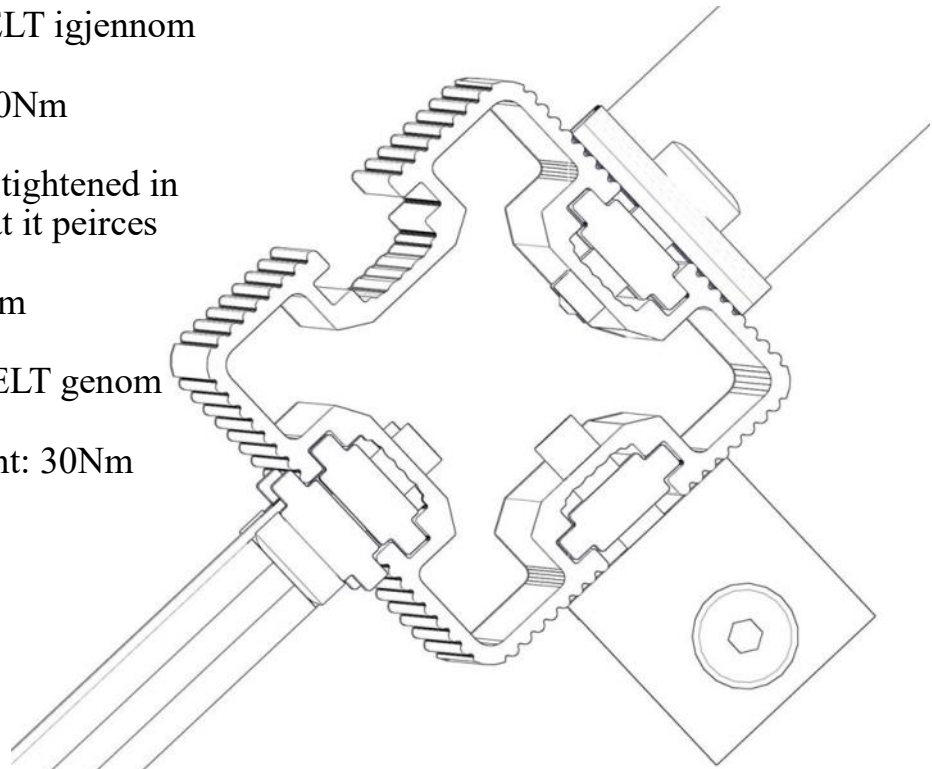

(N) Alle mål er oppgitt

(EN) Scale measured in mm

(S) Alla mått är i millimeter.

## Montering av lekeapparatet / Assembly instructions / Montering av lekredskapet

Se separat delmontering for detaljer  
See separate assembly for details  
Se separata delmontering för detaljer

x2

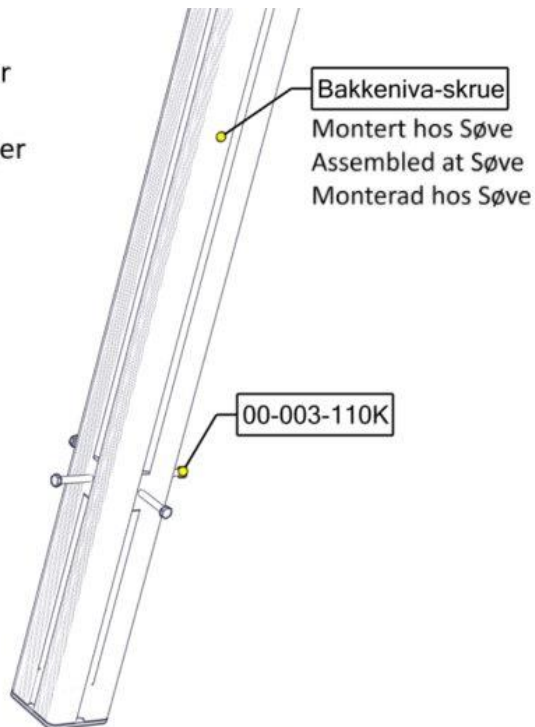

Part Name	Article nr.	Qty
Fundament til støp 95x95 stolpe	00-003-110K	1
Stolpe 95x95 L=4180 (800-3380)	SFA5117/1	1

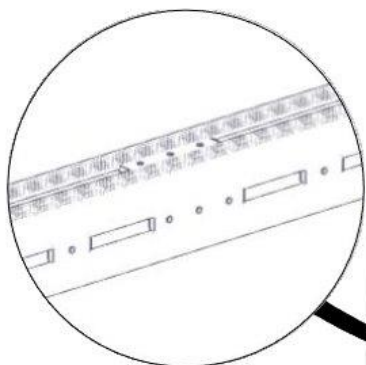

Montert hos Søve  
Assembled at Søve  
Monterad hos Søve

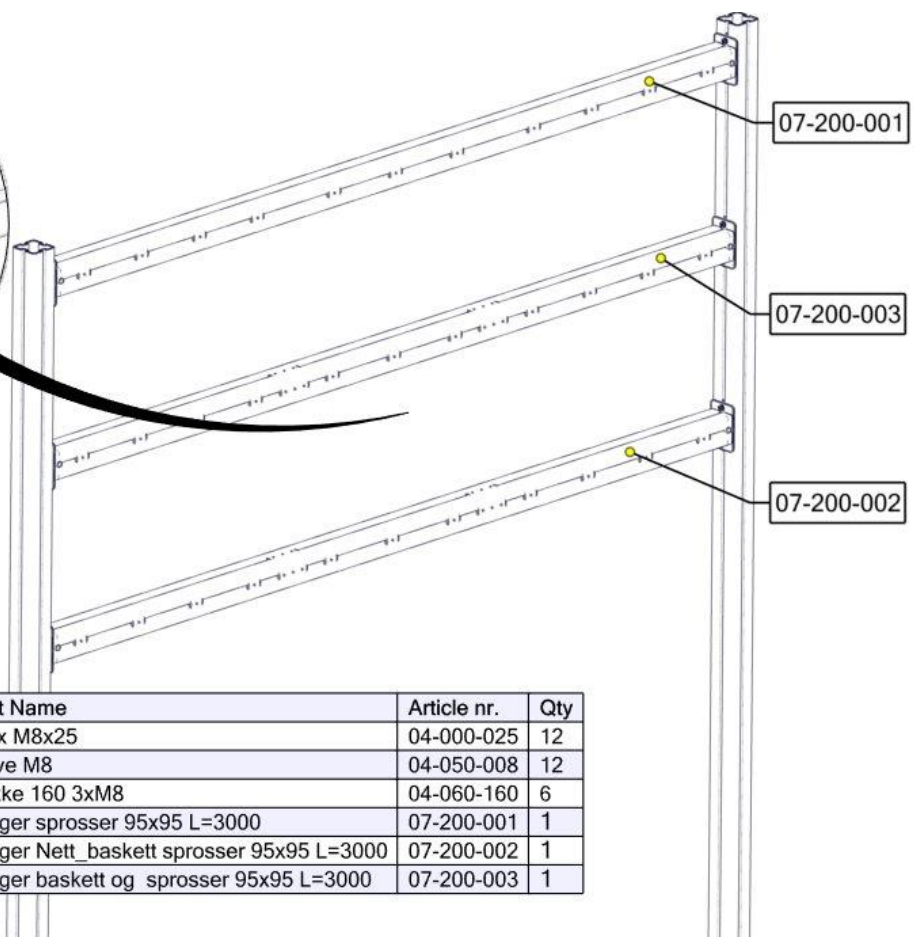

Part Name	Article nr.	Qty
Torx M8x25	04-000-025	12
Skive M8	04-050-008	12
Brikke 160 3xM8	04-060-160	6
Drager sprosser 95x95 L=3000	07-200-001	1
Drager Nett_baskett sprosser 95x95 L=3000	07-200-002	1
Drager baskett og sprosser 95x95 L=3000	07-200-003	1

# Montering av lekeapparatet / Assembly instructions / Montering av lekredskapet

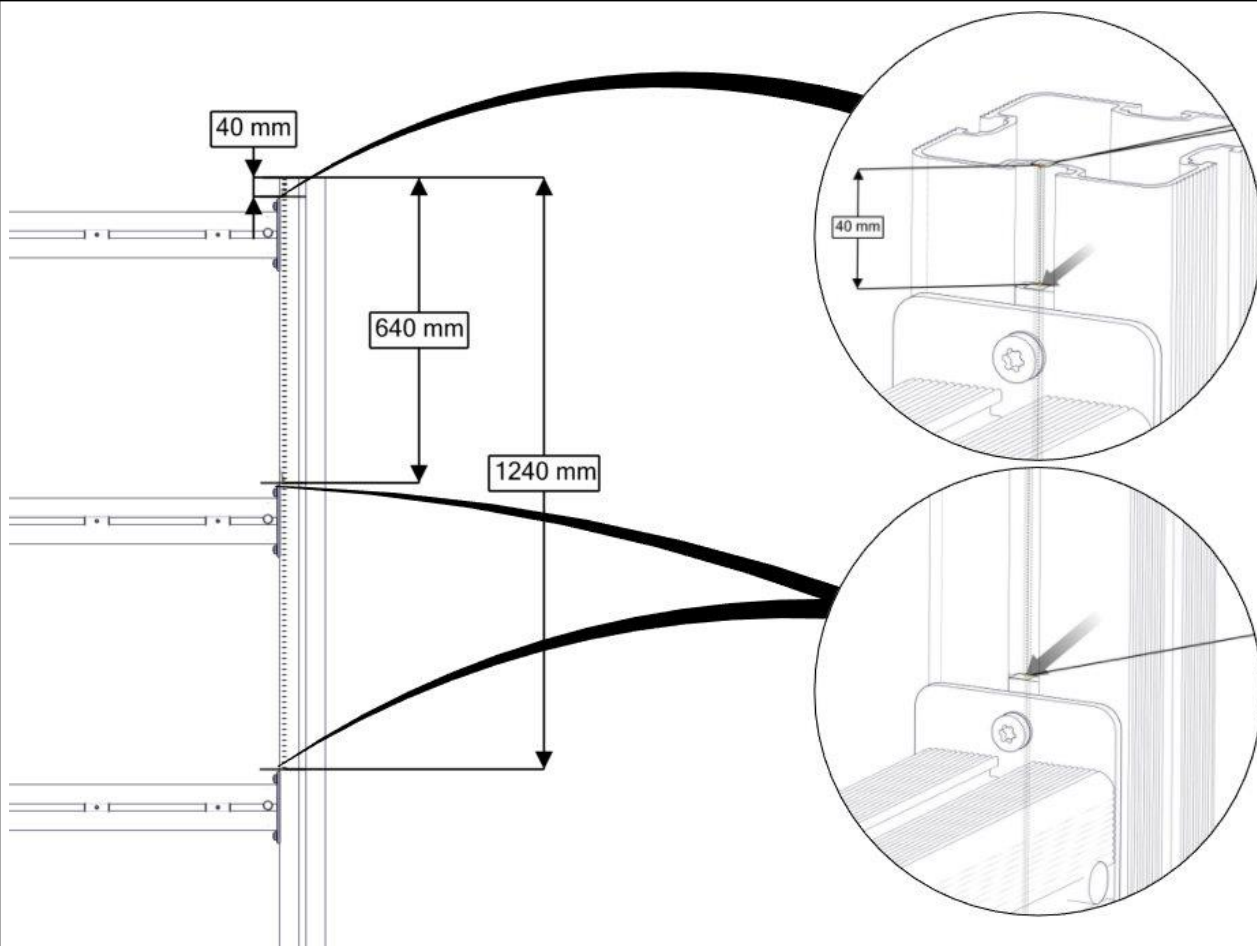
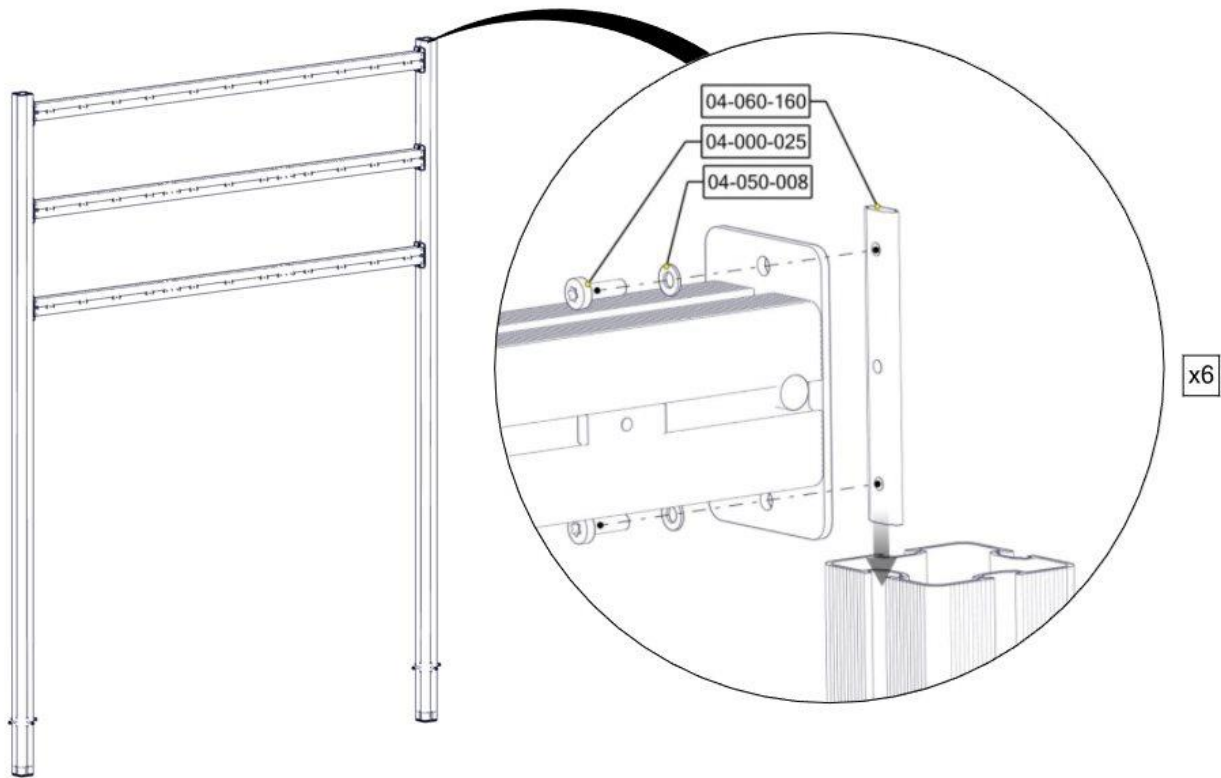

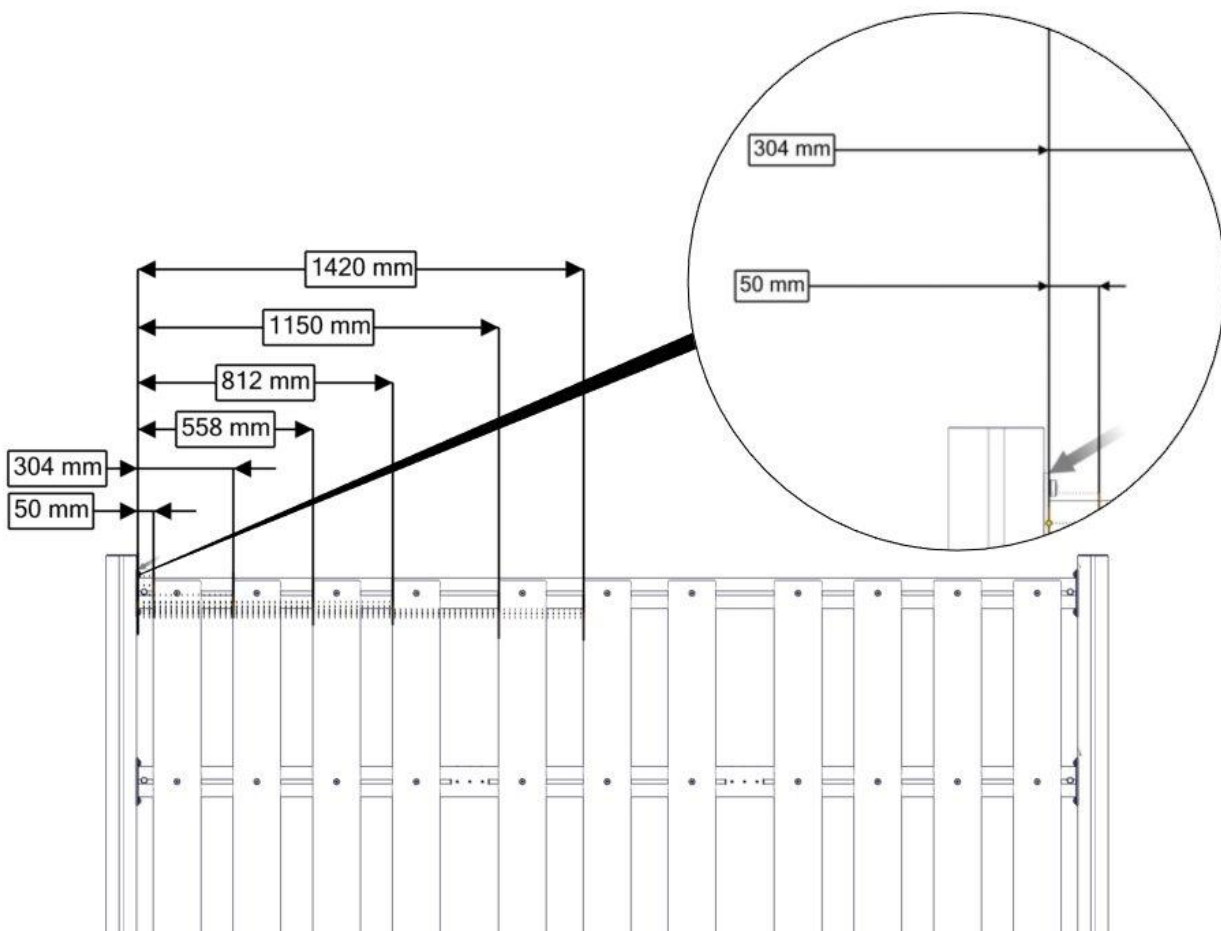
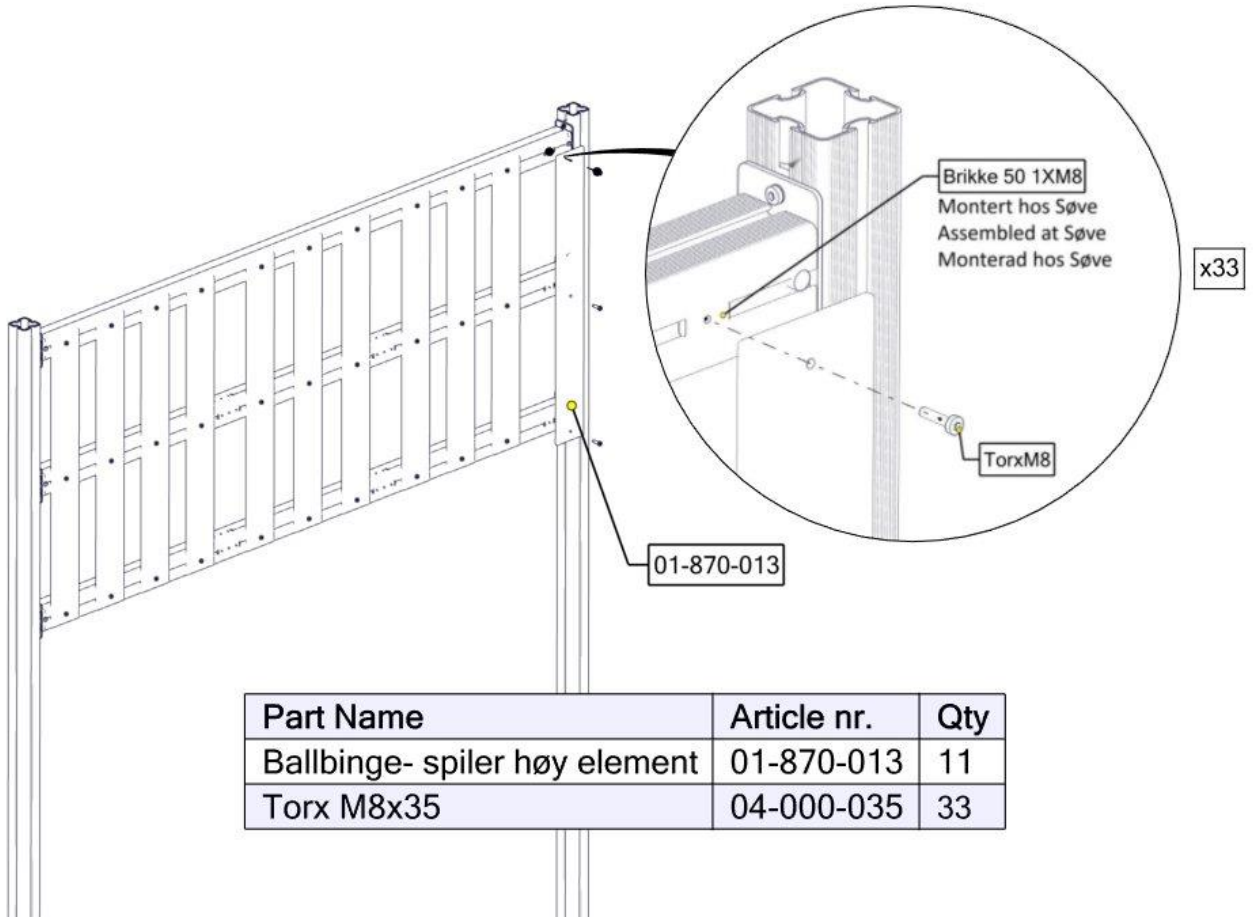

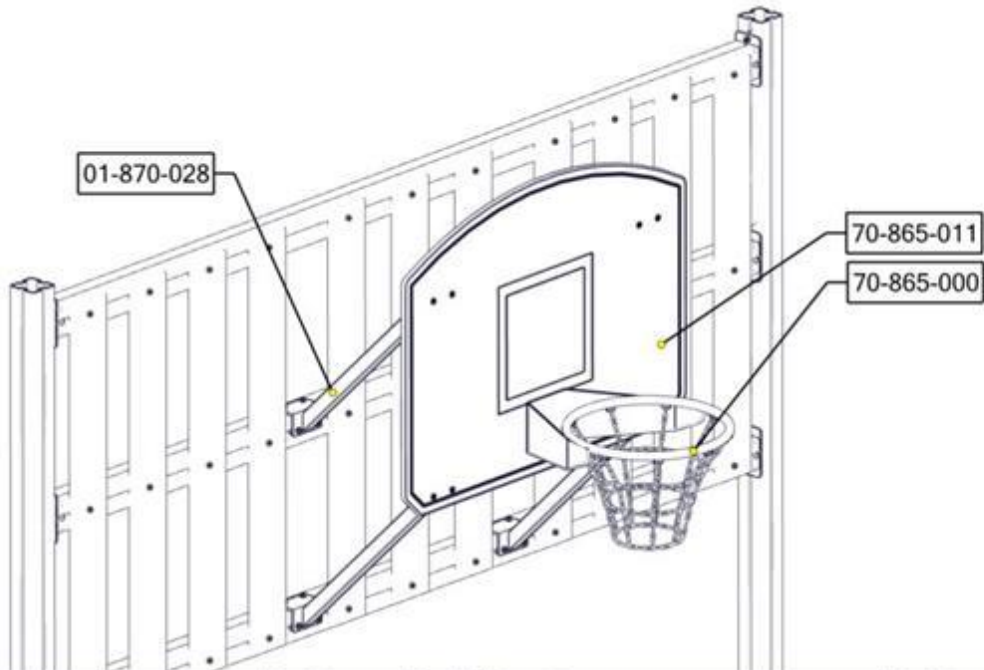

Part Name	Article nr.	Qty
Stag basketballplate ballvegg	01-870-028	4
Torx M8x20	04-000-020	8
Torx M8x30	04-000-030	16
Torx M8x35	04-000-035	4
Møbelknapp M8x11	04-030-011	8

Part Name	Article nr.	Qty
Låsemutter M8	04-040-008	4
Skive M8	04-050-008	32
Basketballkurv m/nett/kjeting- Rustfri	70-865-000	1
Basketplate HPL for ballvegg	70-865-011	1

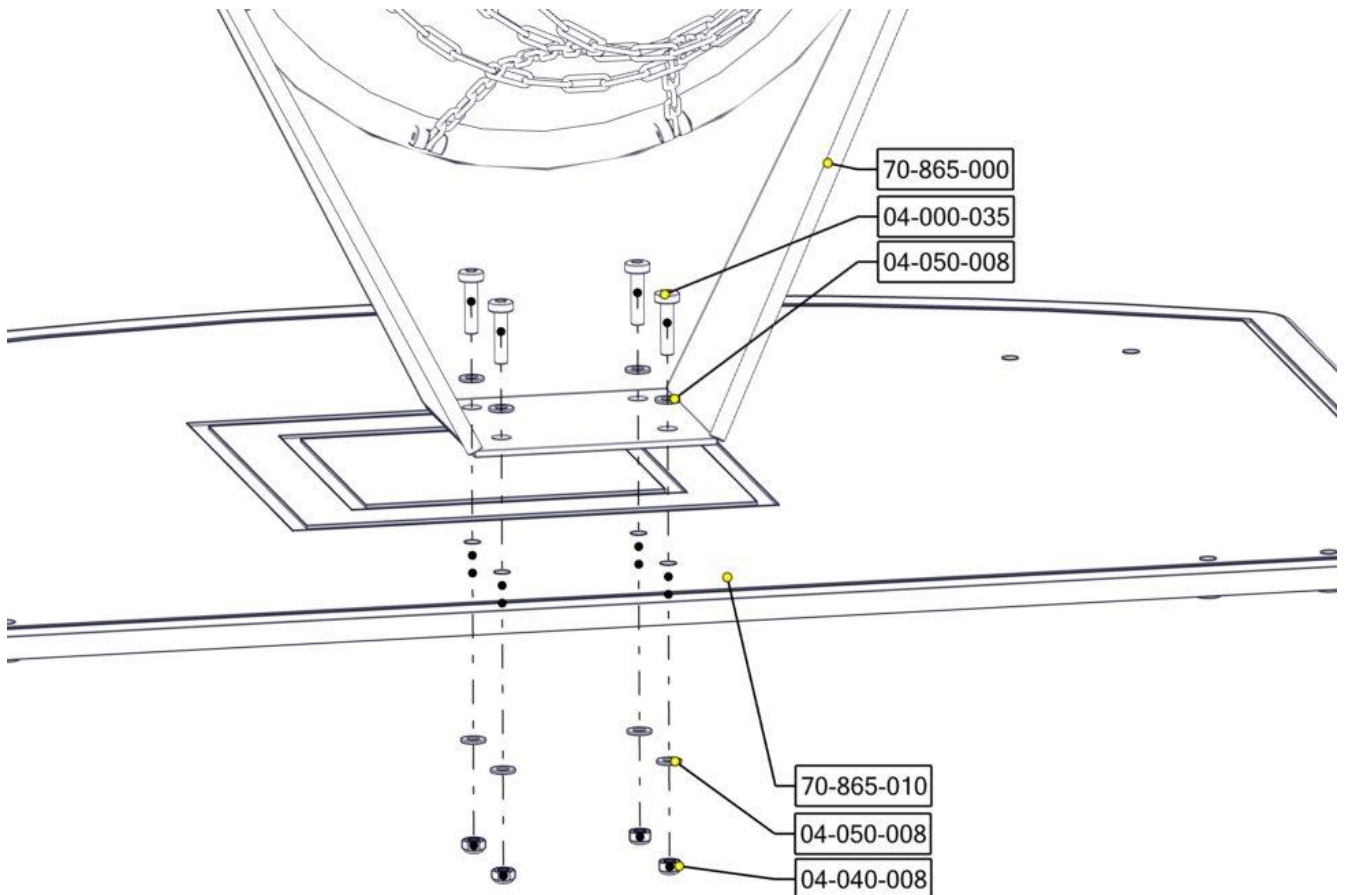



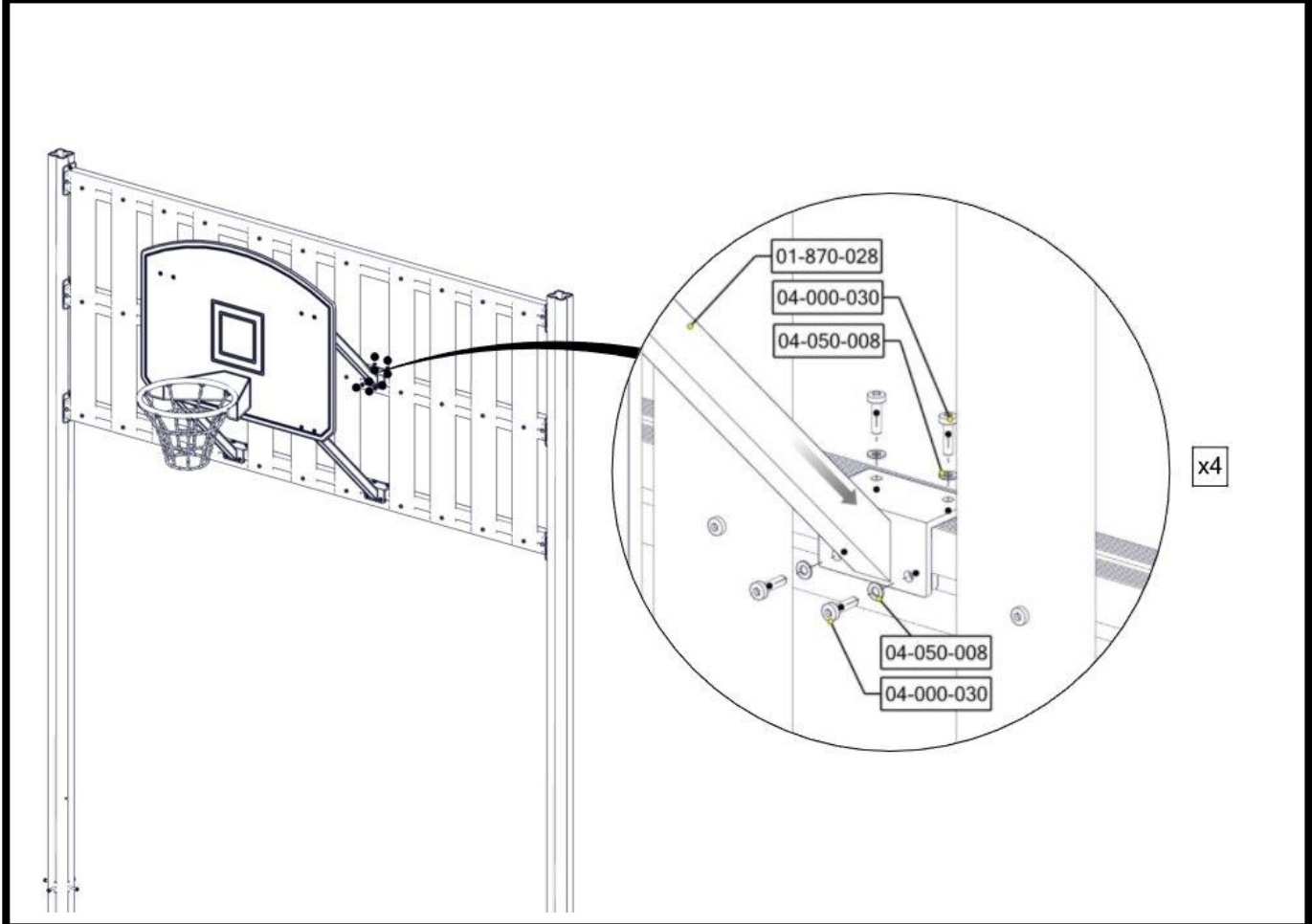
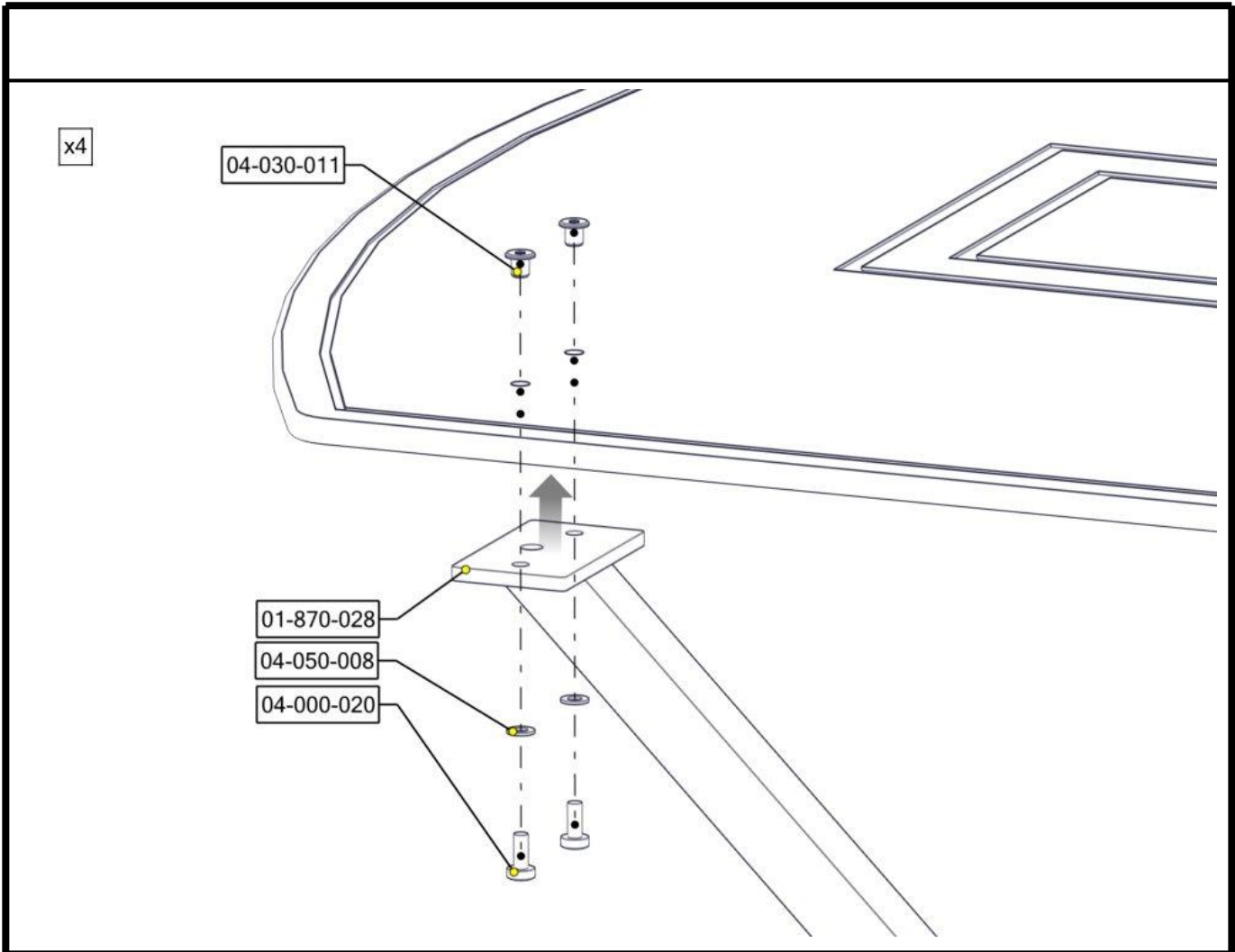

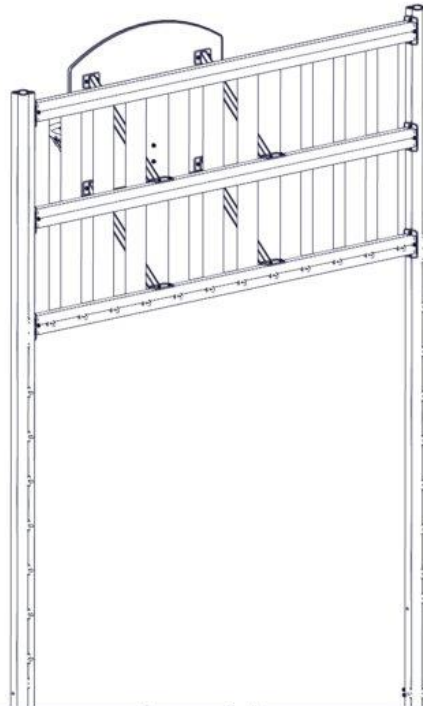

Part Name	Article nr.	Qty
Øyebolt M8x20	04-009-020	26
Brikke 50 1XM8	04-060-050	16

Part Name	Article nr.	Qty
Brikke 160 3xM8	04-060-160	2

2x

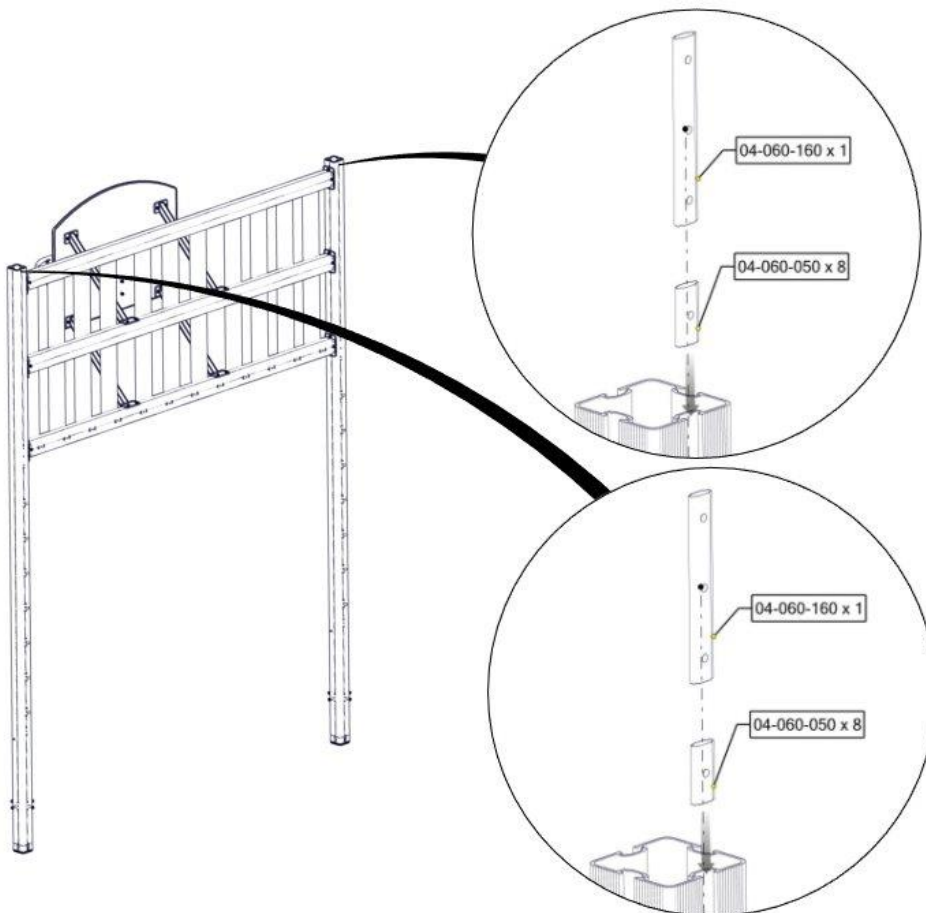

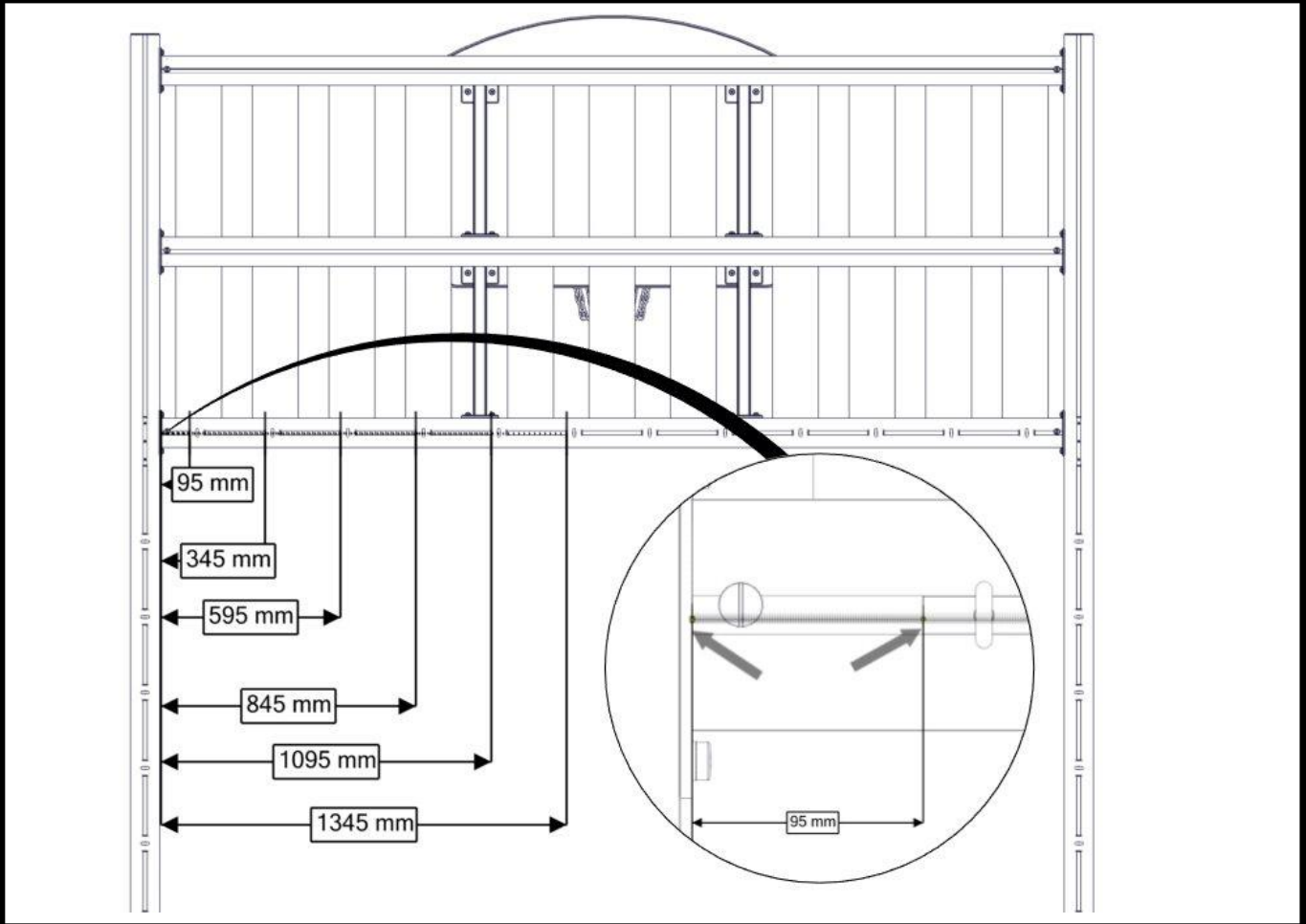
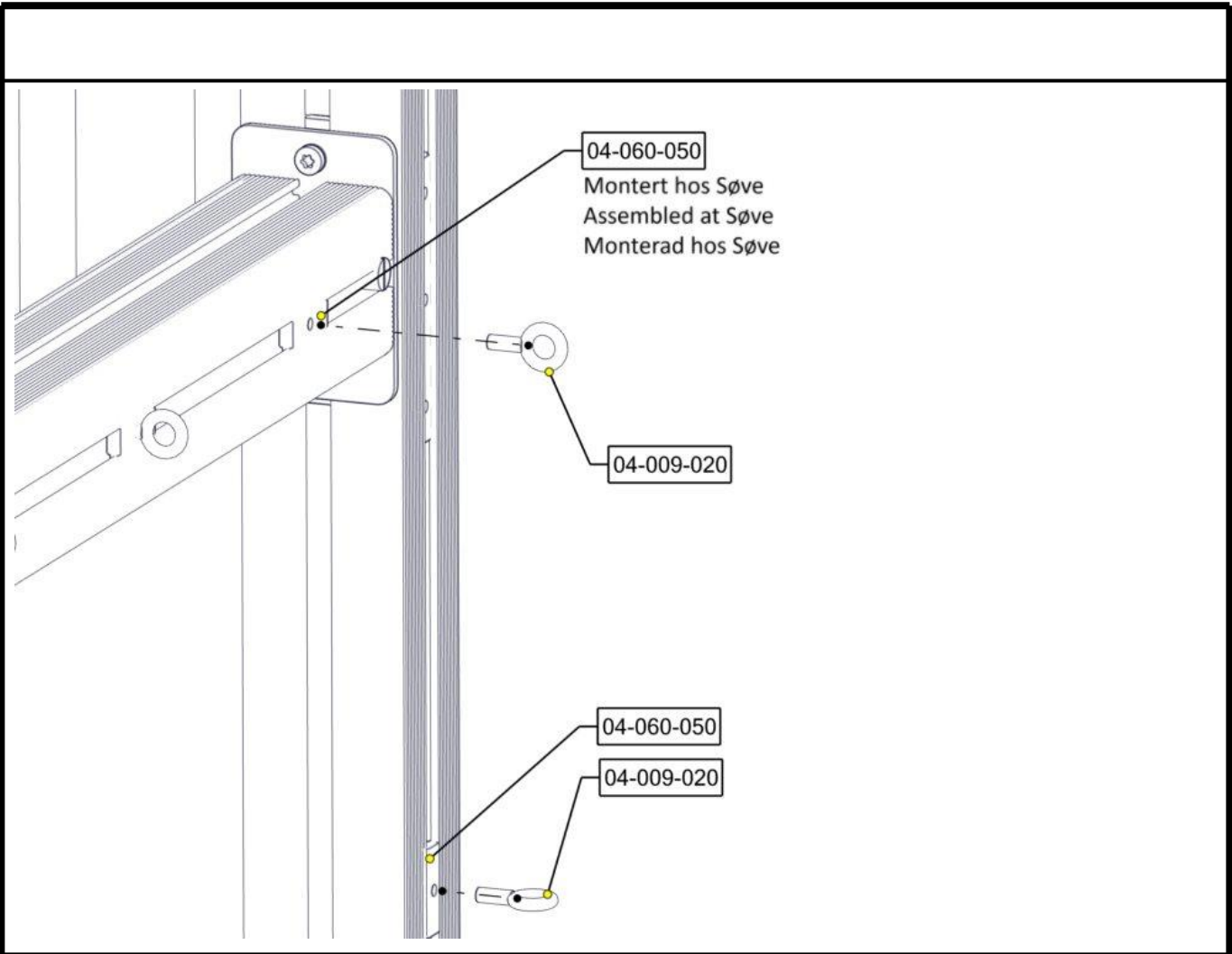

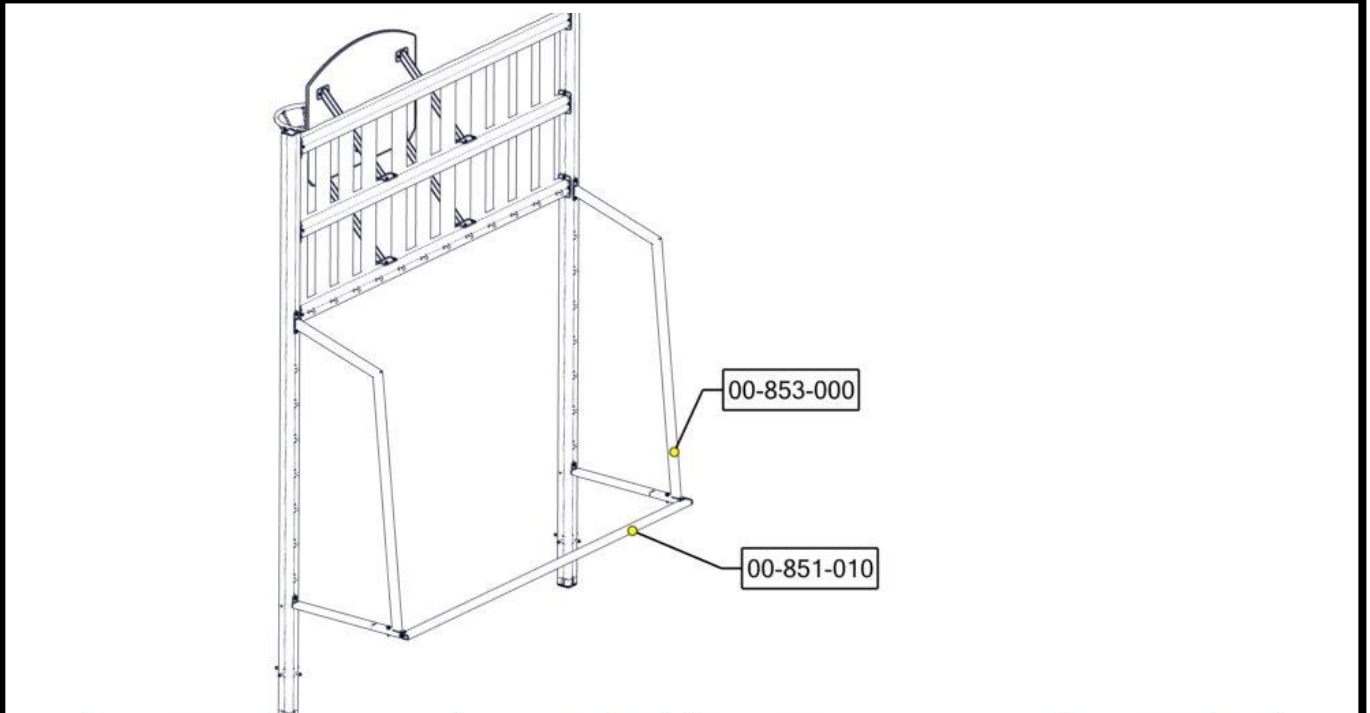
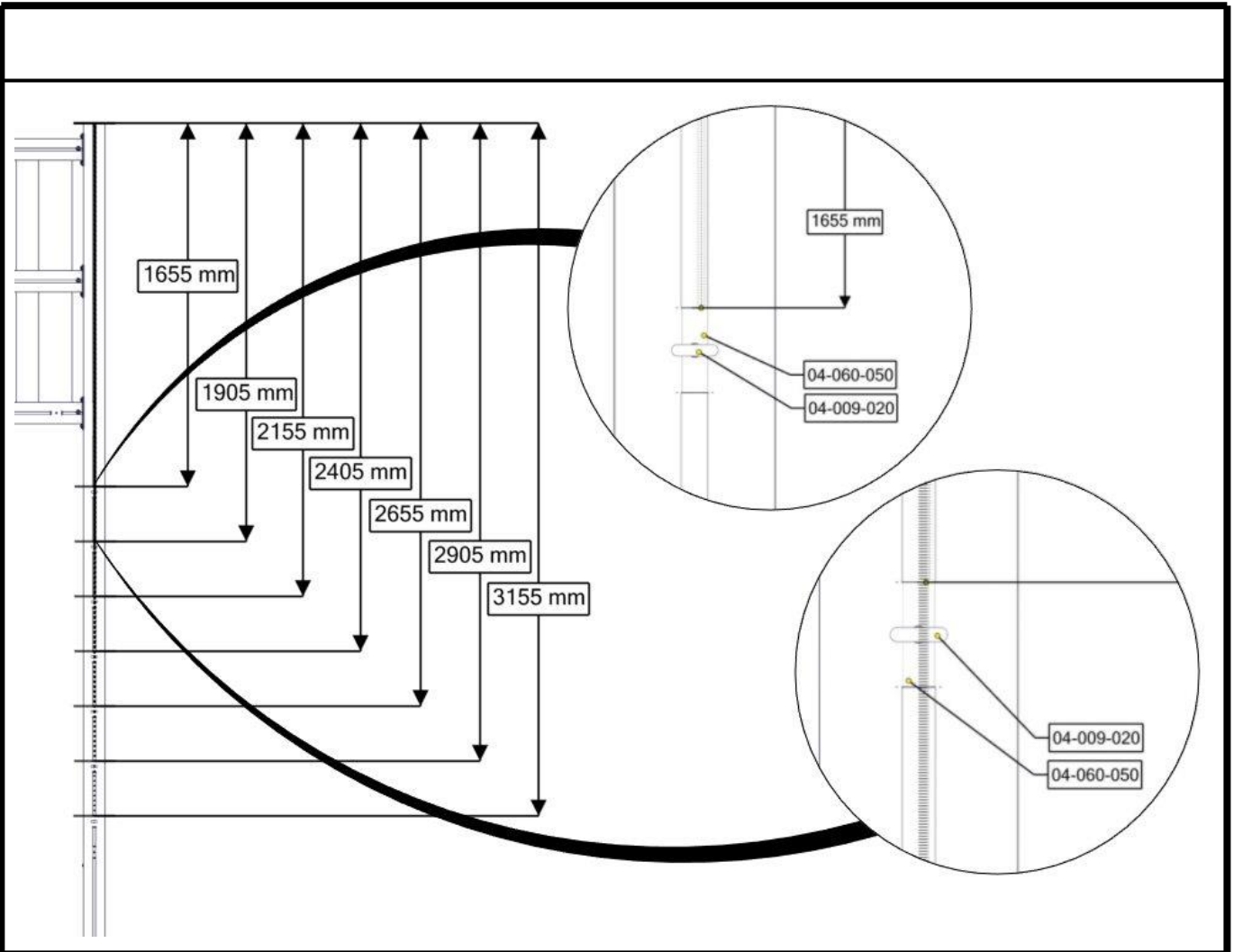

Part Name	Article nr.	Qty
Markkryper til Skolemål L=3159	00-851-010	1
Bøyle til skolemål	00-853-000	2
Torx M8x30	04-000-030	6
Sekskant skrue M10x55	04-010-055	2

Part Name	Article nr.	Qty
Låsemutter M10	04-040-010	2
Skive M8	04-050-008	6
Skive M10 stor	04-055-010	4

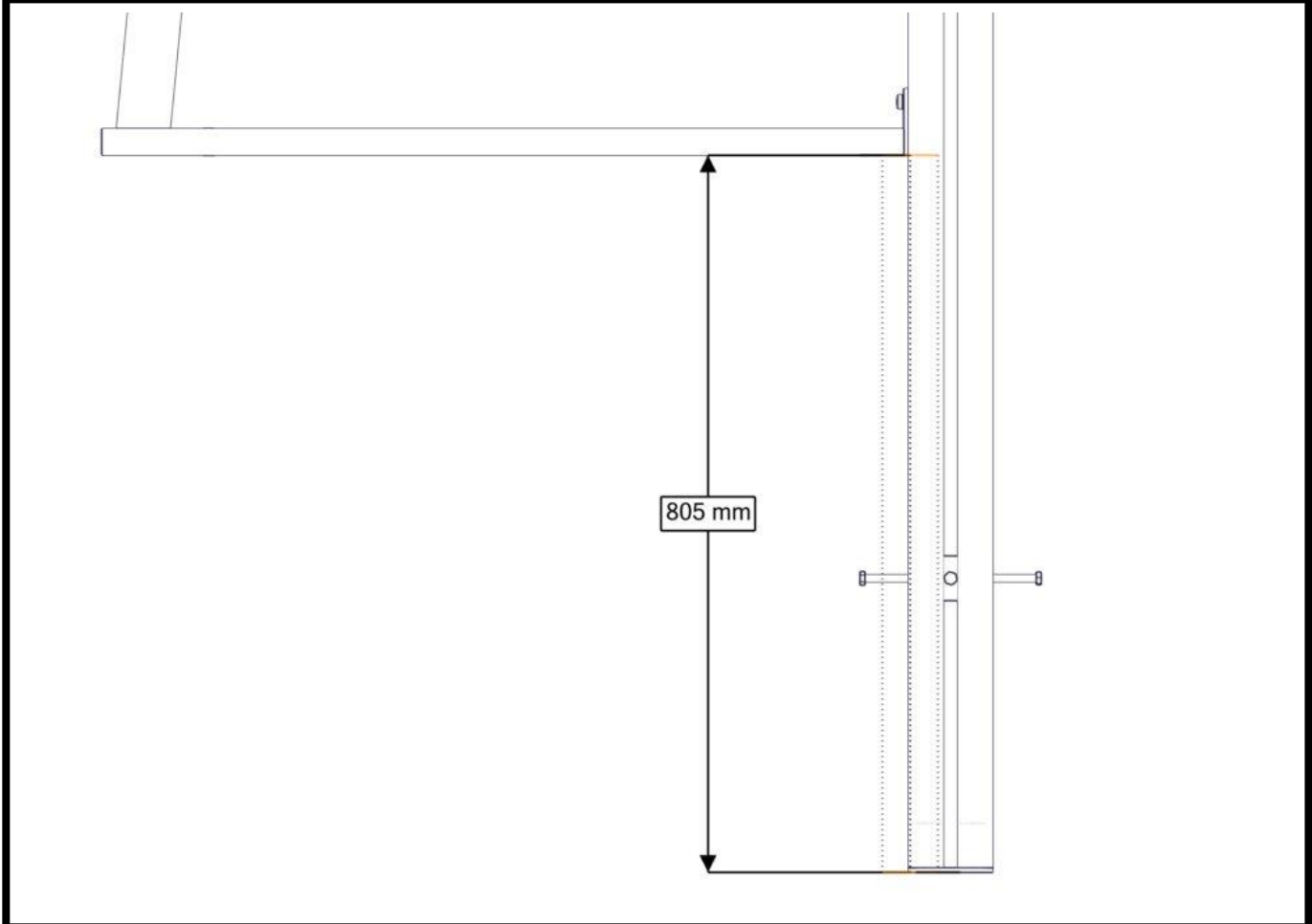
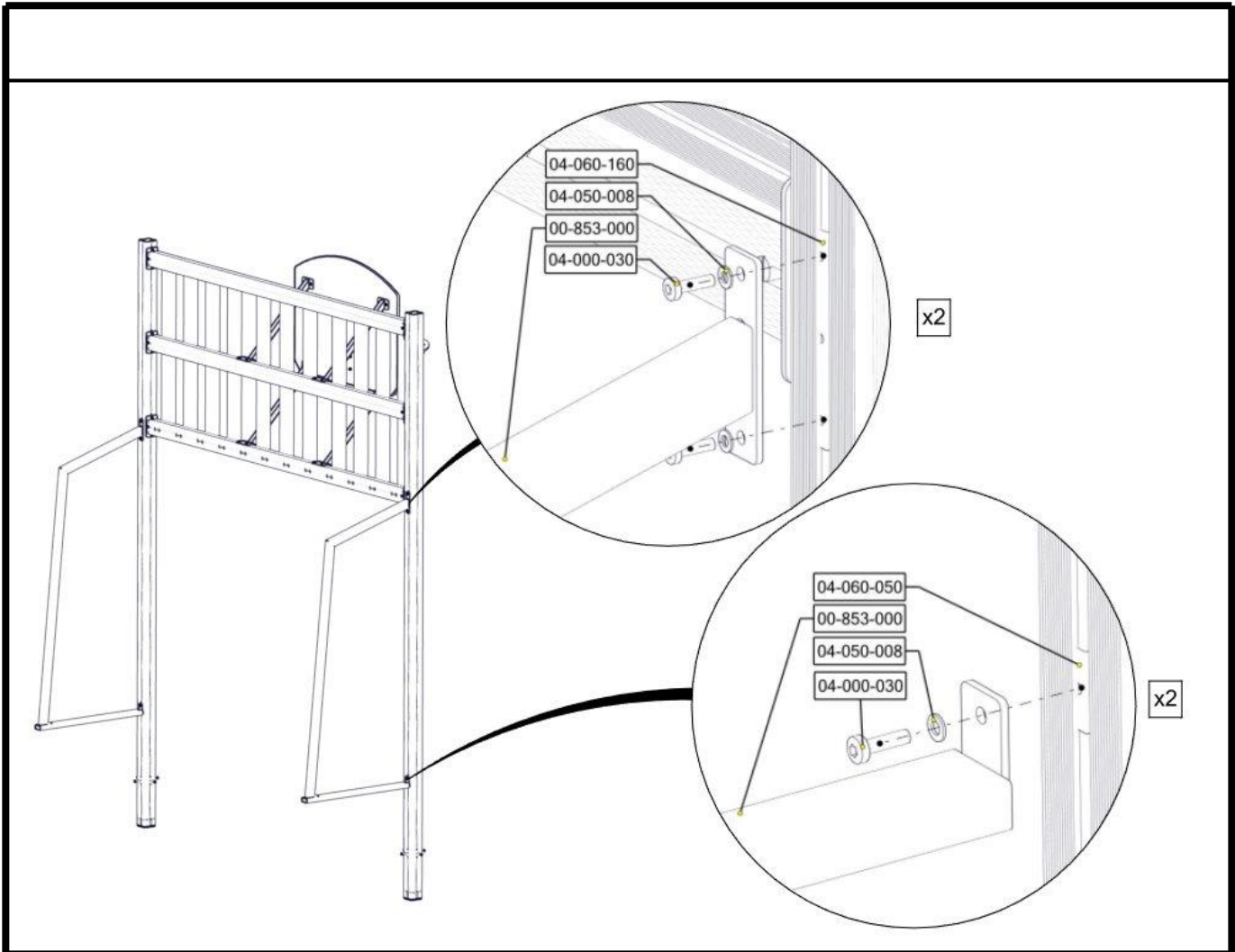

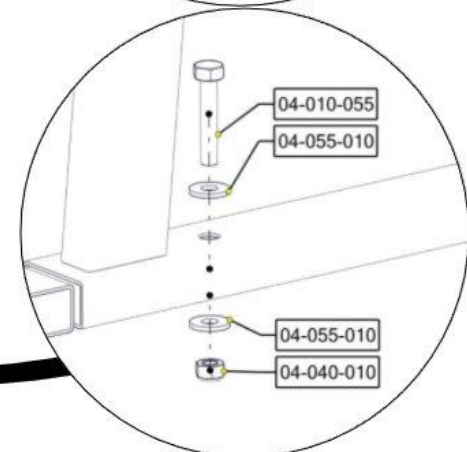
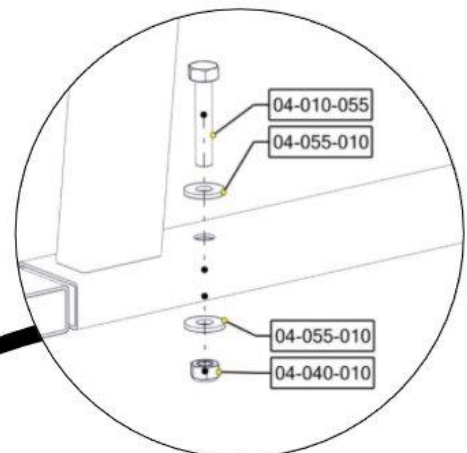
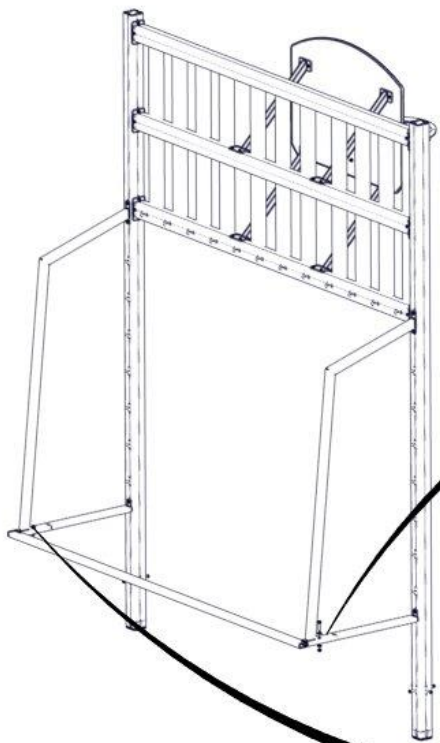
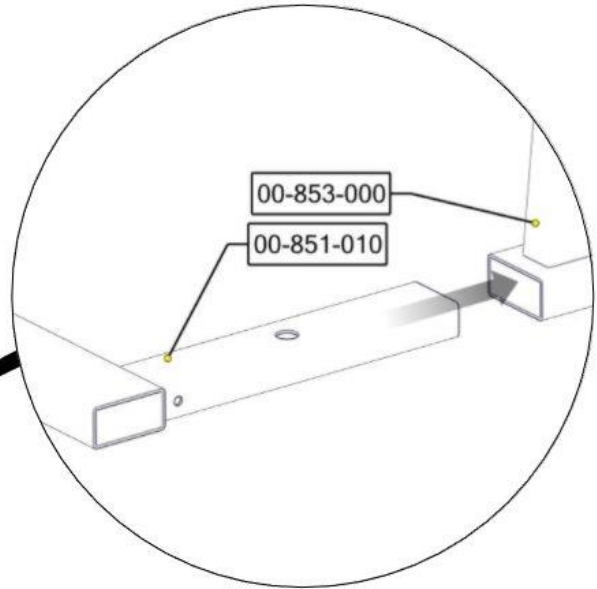
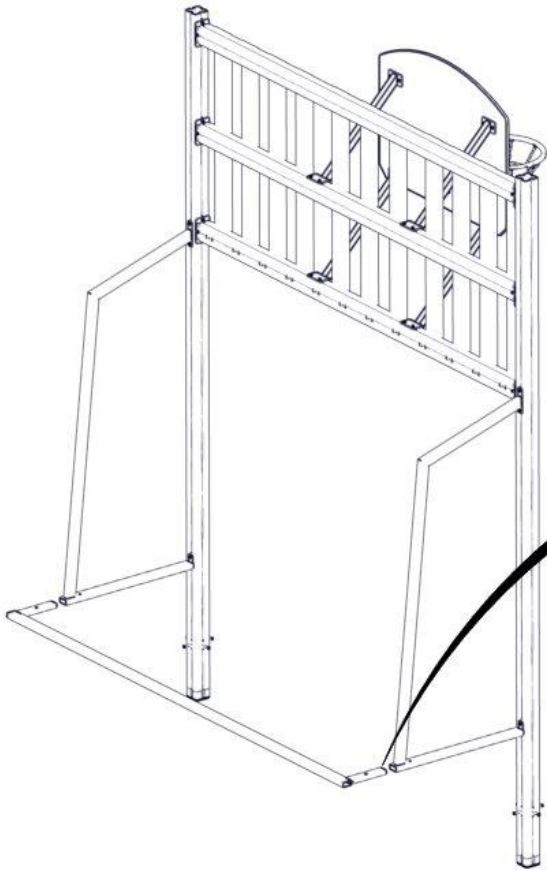

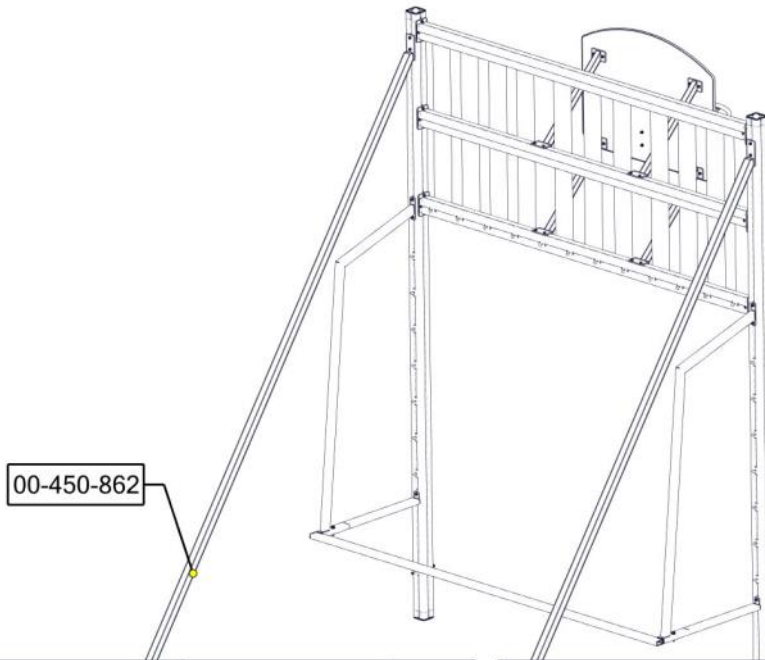

Part Name	Article nr.	Qty
Endelukk 95x95	00-400-998	2
Torx M8x25	04-000-025	4
Skive M8	04-050-008	4

Part Name	Article nr.	Qty
Brikke 120 3xM8	04-060-120	2

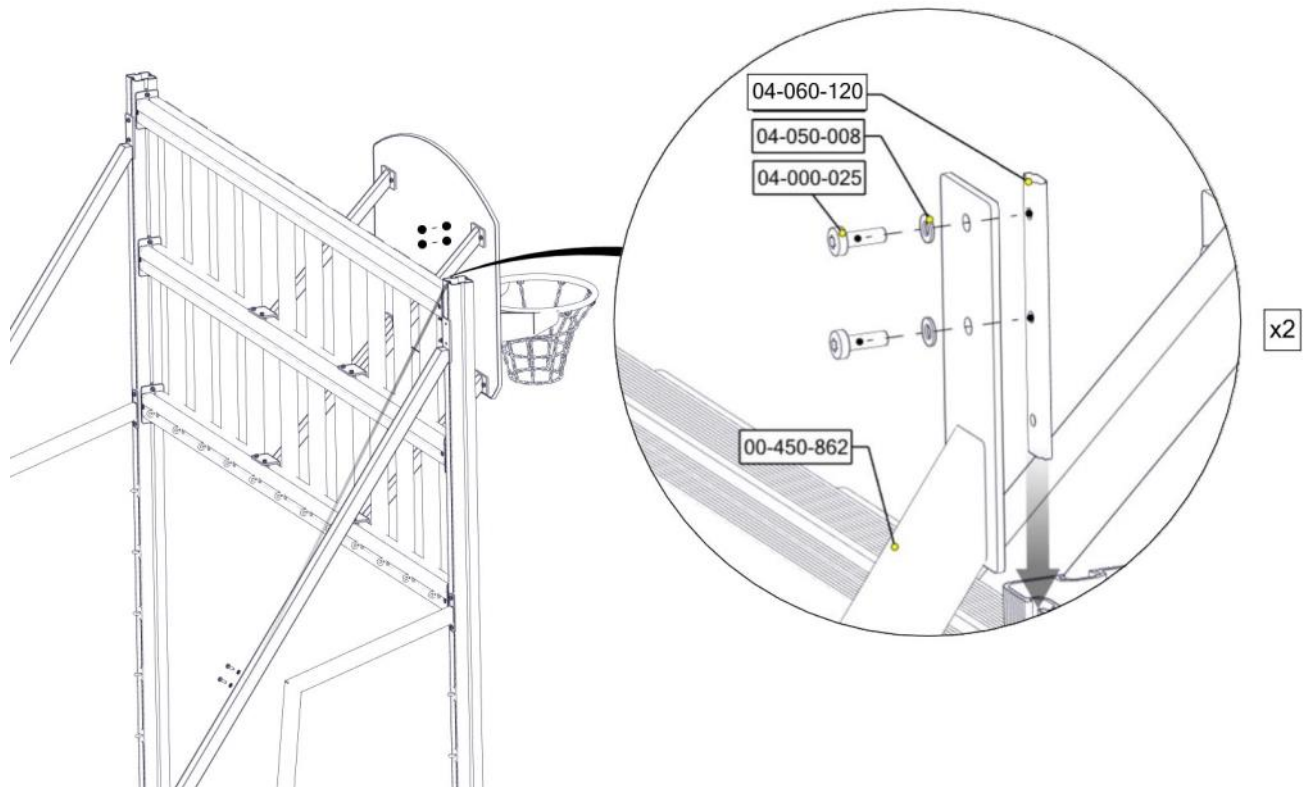

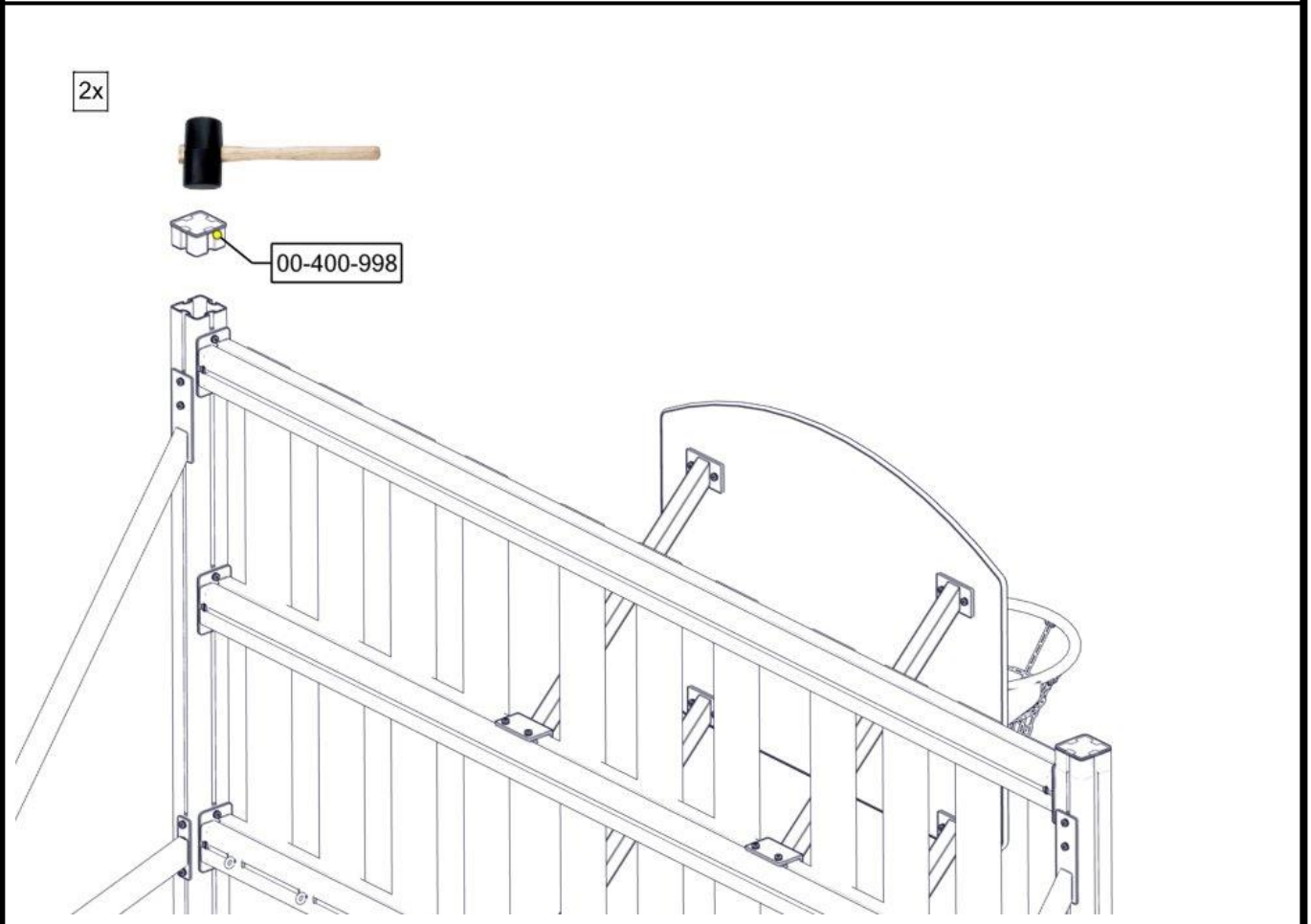
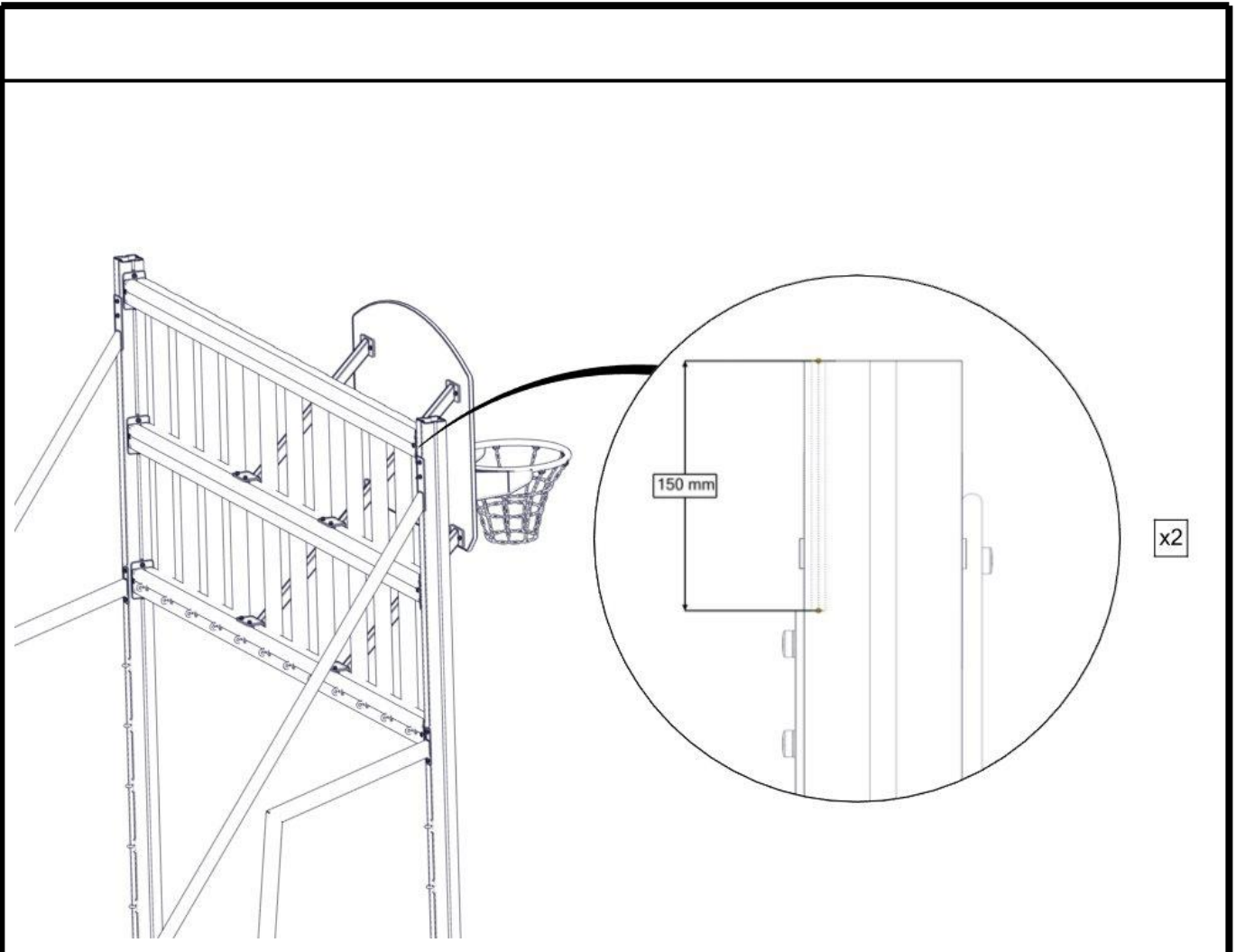



4x

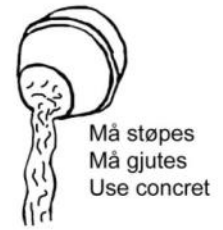
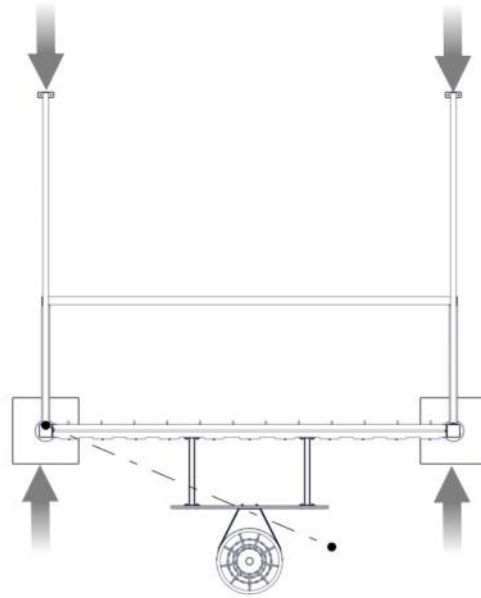

Nett må bestilles separat  
Nets must be ordered separately

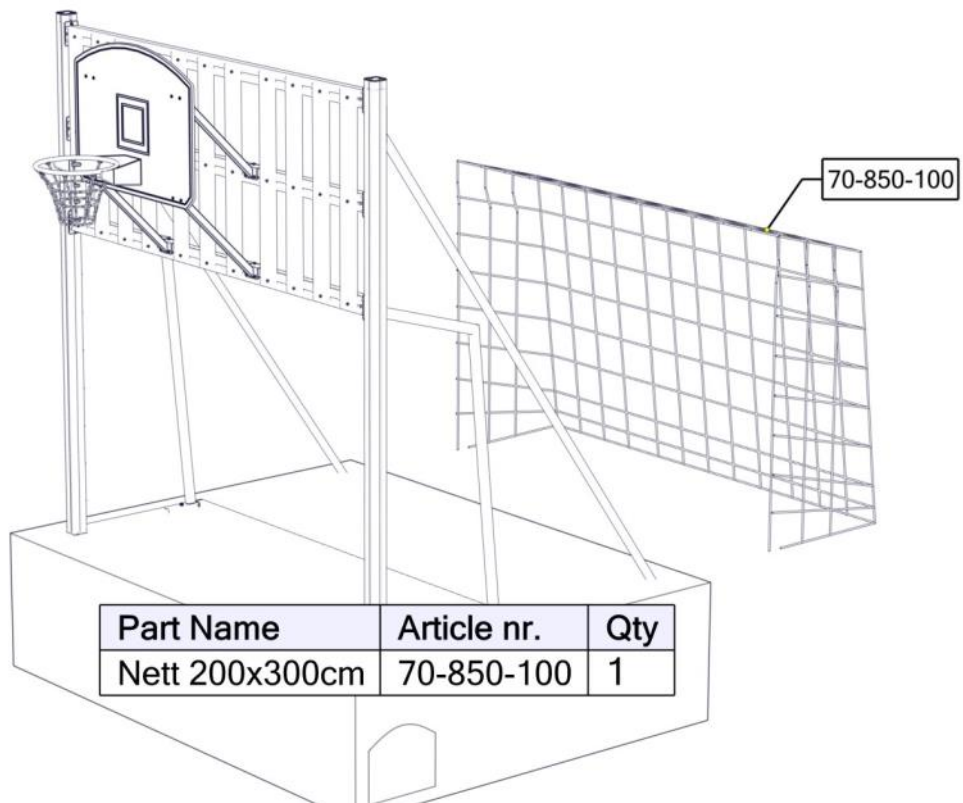

Part Name	Article nr.	Qty
Nett 200x300cm	70-850-100	1

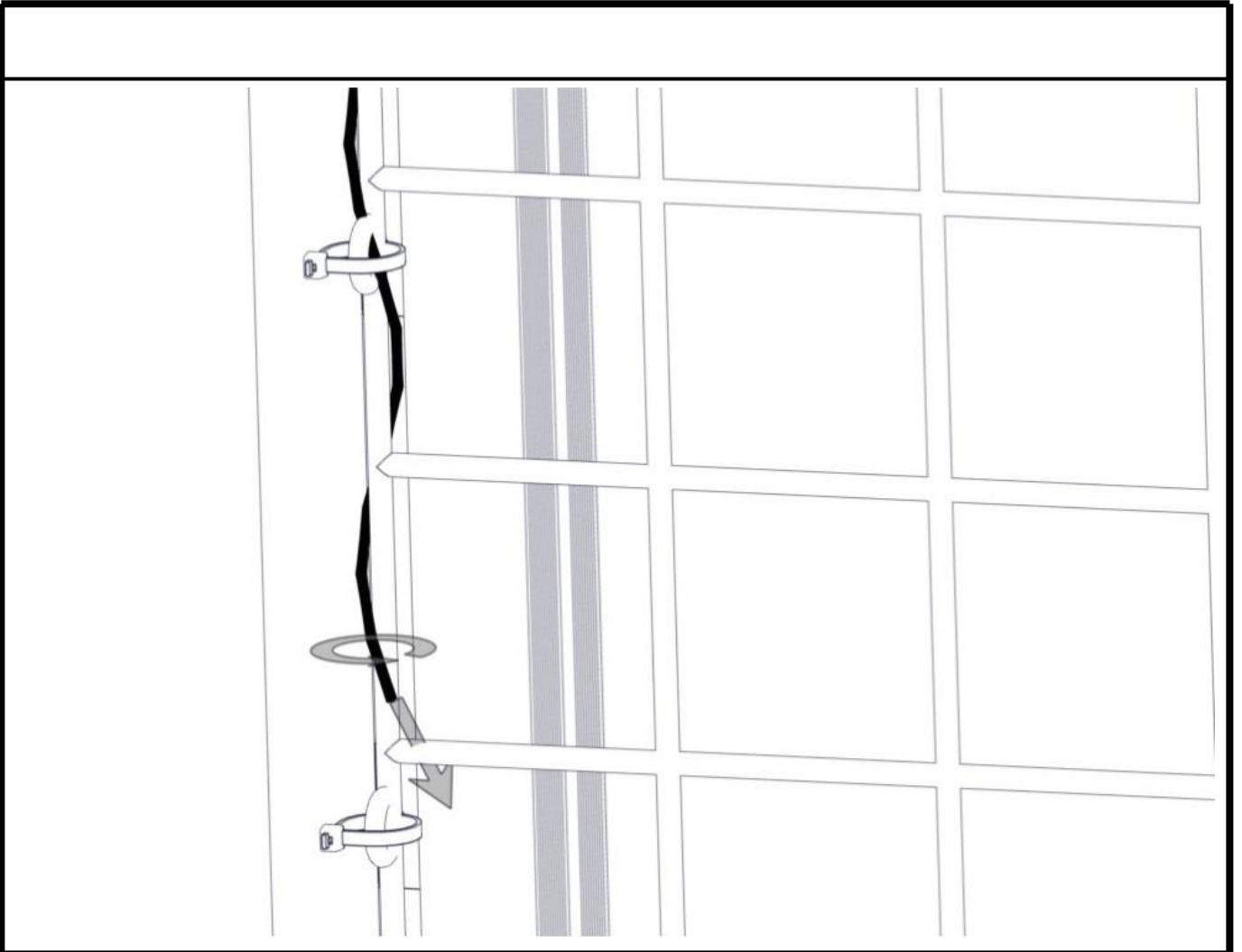





<b>Før utstyret tas i bruk / Before play begins / Innan lekredskapet tas i bruk</b>	
<b>N</b>	<ul style="list-style-type: none"> <li>● Påse at fallunderlag er utlagt i henhold til gjeldende regler eller vår anbefaling</li> <li>● Fjern alle monteringshjelpemidler ( rester av betong, planker, paller, plast, og lignende)</li> <li>● Før utstyret tas i bruk, burde man sjekke at det ikke er fare for at anorakksnorer og lignende som kan hekte seg fast noen steder på lekeapparatet. (Vedlagte snor med dobbe (kneledd) kan brukes til å sjekke at dette er i orden. Se vedlagte veiledning for bruk av denne. Dette gjøres for å oppdage eventuelle feilmonteringer.?)</li> <li>● NB! Bør stå i 2-3 dager før bruk</li> </ul>
<b>EN</b>	<ul style="list-style-type: none"> <li>● Make sure the area and depth of safer surfacing are according to the current standard, or to the manufacturer's recommendation</li> <li>● Make sure all tools and surplus materials are removed before play begins</li> <li>● PS! When complete, allow 2-3 days for the concrete to set before use</li> </ul>
<b>S</b>	<ul style="list-style-type: none"> <li>● Kontrollera att fallunderlag är utlagt enligt gällande regler eller vårt rekommendation</li> <li>● Ta bort alla monteringshjälpmedel (rester av betong, plankor, pallar, plast och liknande)</li> <li>● Innan lekredskapet används, kontrollera att anoracksnoddar eller kläder/delar av kläder eller liknande inte kan fastna i några delar på redskapet. (Den bipackade "knävringen" kan man med fördel användas för denna kontroll.</li> <li>● Detta görs för att upptäcka eventuella felmonteringar.)</li> </ul>



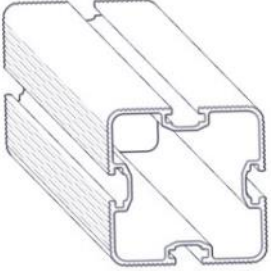

**Boltepakker for / Boltpackage for / Bultpaket för**

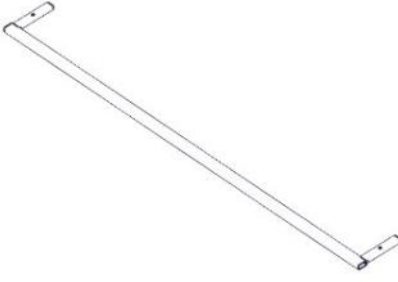

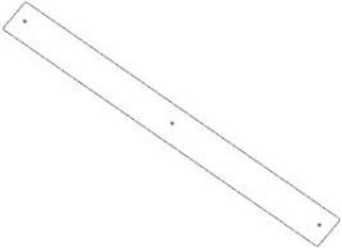
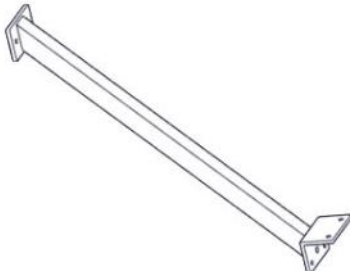

Sign. \_\_\_\_\_

Mål med basketballkurv 70-870-025	Navn	Artnr/ dimensjon	Ant	Lev
	Stolpe 95x95 Lengde = 4180 (800-3380) Sort	SFA5117/1	2	
	Drager sprosser 95x95 L=3000 Sort	07-200-001	1	
	Drager Nett-Basket sprosser 95x95 L=3000 Sort	07-200-002	1	
	Drager basket og sprosser 95x95 L=3000 Sort	07-200-003	1	
	Bøyle til skolemål	00-853-000	2	
	Markkryper til skolemål	00-851-010	1	

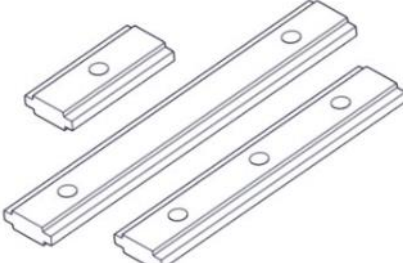
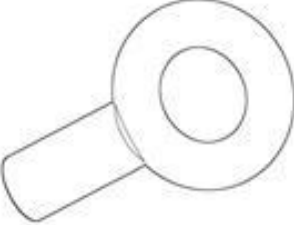
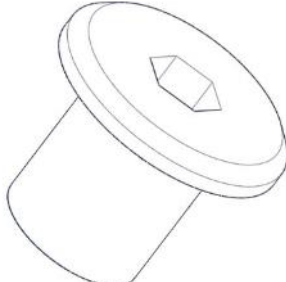
**Boltepakker for / Boltpackage for / Bultpaket för**

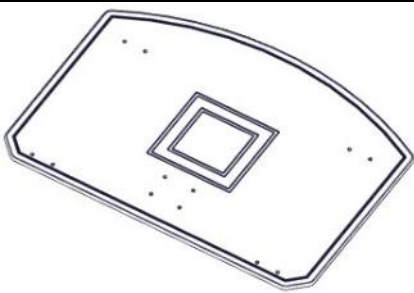

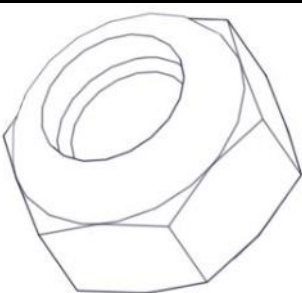
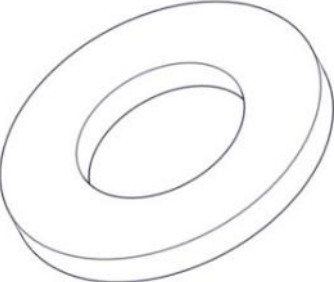
Sign. \_\_\_\_\_

Mål med basketballkurv 70-870-025	Navn	Artnr/ dimensjon	Ant	Lev
	Ballbinge– spiler høy element	01-870-013	11	
	Stag basketballplate ballvegg	01-870-028	4	
	Torx M8x20 Torx M8x30 Torx M8x25 Torx M8x35	04-000-020 04-000-030 04-000-025 04-000-035	8 22 16 37	
	Brikke 50 1xM8 Brikke 120 3xM8 Brikke 160 3xM8	04-060-050 04-060-120 04-060-160	16 2 8	
	Øyebolt M8x20	04-009-020	26	
	Møbelknapp M8x11	04-030-011	8	

<b>Boltepakker for / Boltpackage for / Bultpaket för</b>		Sign. _____		
<b>Mål med basketballkurv 70-870-025</b>	<b>Navn</b>	<b>Artnr/ dimensjon</b>	<b>Ant</b>	<b>Lev</b>
	Basketballkurv m/nett/kjetting -rustfri	70-865-000	1	
	Basketball plate For vegg montering	70-865-011	1	
	Bolt M10x55 Sekskant	04-010-055	2	
	Låsemutter M10 Låsemutter M8	04-040-010 04-040-008	2 4	
	Skive M8 Skive M10 Stor	04-050-008 04-055-010	54 4	
	Merkeskilt	00-100-400 (Montert hos Søve)	0	

**Boltepakker for / Boltpackage for / Bultpaket för**

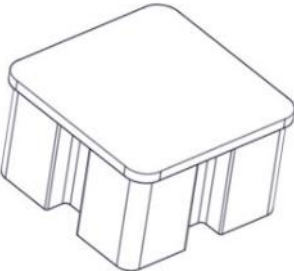
Sign. \_\_\_\_\_.

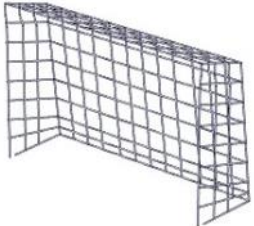
Mål med basketballkurv 70-870-025	Navn	Artnr/ dimensjon	Ant	Lev
	Endelokk 95x95 Sort	00-400-998	2	
	Stag ballvegg skrå (70-870-010/025) over mål L=4,8 meter	00-450-862	2	
	Nett 200x300cm Grønt (Kan kjøpes hos Søve)	70-850-100	0	



**Boltepakker for / Boltpackage for / Bultpaket för**

Sign. \_\_\_\_\_.

Mål med basketballkurv 70-870-025	Navn	Artnr/ dimensjon	Ant	Lev
	<b>Fundament Støp</b>			
	Støpefundament 95 x 95 stolpe	00-003-110K (Se egen Delmontering)	2	

MTK 02-03-2023

Forandring brikke forankering 00-450-862 (og ikke 00-450-861)

Og det betyr også bytte 160 brikke til 120 brikke