

N

**Monteringsanvisning**

EN

**Assembly Instructions**

S

**Monteringsanvisning**

Produkt nr. / Product no. / Produkt nr.

**81-151-611****Grå**

Ord. nr. \_\_\_\_\_

Dato. \_\_\_\_\_

Sign. \_\_\_\_\_

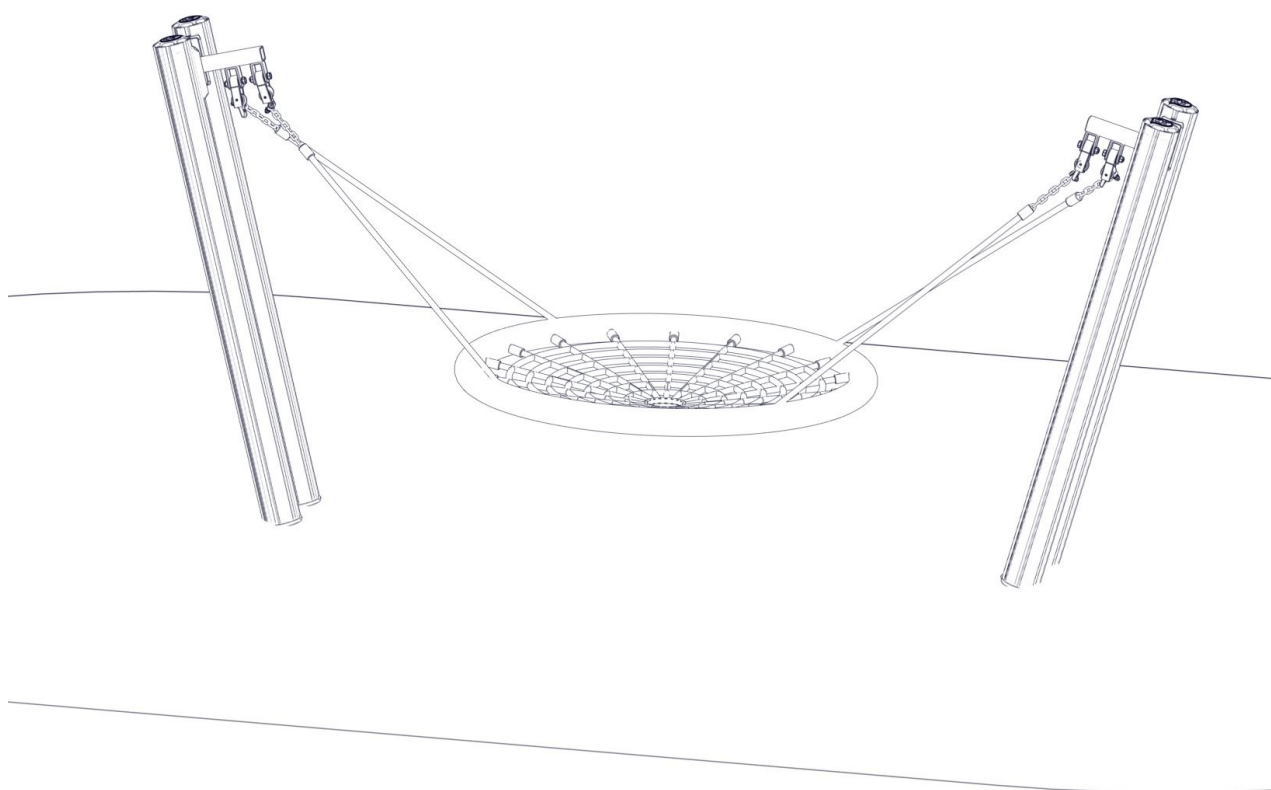
**søve**

Søve AS  
 Grønnvoldveien 290  
 3830 Ulefoss - Norway  
 Tlf: +47 35 94 65 65  
 www.sove.no



Søve AB  
 EA Rosengrensgatan 32  
 421 31 Västra Frölunda  
 Phone: +46 (0)31 773 97 00  
 www.sove.se

## Monteringstips / Assembly Advice / Monteringsstips

**N**

- Les monteringsanvisningen nøye før montering.
- Monter elementene i rekkefølgen som vist.
- Boltene bør ikke skrues for hardt til før alt er montert, vatret og loddet. Skru så boltene til.
- NB! Ved bruk av drill, kan boltene ryke.
- Er lekeutstyret plassert i naturlige ferdselstraséer må området sikres mot gjennomgang.
- Innspringningshinder bør vurderes rundt lekeapparater hvor det er stor bevegelse, f.eks. ved huskestativ.
- Det bør være fritt innsyn til lekeutstyr som er beregnet for barn under 3 år.

**NB! Under monteringsarbeidet må utstyr, som ikke er forankret forsvarlig i bakken, sikres slik at det ikke velte.**

**Området må avstenges under montering av apparatene med sperrebånd eller lignende.**

**EN**

- Read the instruction carefully before assembling the play unit..
- Assemble the components in the sequence shown in these instructions.
- Fixings must not be fully tightened during assembly. Before casting the foundations, the structure must be level and plumb, at which point all fixings are tightened.
- PS! If use of drill, the bolts may be wrecked.
- Secure the construction-area to prevent people from walking through it.
- Consider installing barriers around play-equipment which gives rise to a lot of activity – i.e.swings.
- Ensure that clear vision is possible across the play area so that supervision is possible from any position, particularly where children under 3 years of age will be playing.

**NB! During assembly of the equipment, ensure that all structures are securely propped, especially when left overnight. Also ensure that equipment is supported whilst concrete foundations are setting and enclose the area securely to prevent access.**

**Monteringstips / Assembly Advice / Monteringsstips****S**

- Läs monteringsanvisningen noga före montering.
- Montera delarna i den ordningen som anvisas
- Skruvarna bör inte skruvas för hårt tills allt är monterat, i våg och lodat.









OBS! Används elektrisk skruvdragare, kan bulten gå sönder. Hårdra därför manuellt!

- Om lekplatsen placeras vid en gångväg mm bör området säkras mot genomfart av gående och cyklister.
- Insprängningshinder bör placeras runt lekutrustning med stor rörelse, t ex, gungställning.
- Det bör vara fri insyn till lekutrustning beräknat till barn under 3 år.

**OBS! Under monteringsarbete bör utrustningen som inte ska förankras i marken, ställs så att den inte kan välta.**

**Området måste spärras när lekutrustningen byggs upp, med avspärrningsband eller liknande.**

**Nødvendig verktøy / Tools required / Nödvändiga verktyg**

<p>(N)</p> <p>(EN)</p> <p>(S)</p>	<p>(A)</p> 	<p>(B)</p>  <p>Torx Nr 45 High quality</p>	<p>(C)</p>  <p>13</p>	<p>(D)</p> 	<p>(E)</p> 
		<p>Metermål</p> <p>Metric measure</p> <p>Tumstock</p> 		<p>Merkebånd</p> <p>Mark ribbon</p> <p>Märkeband</p> 	

**Nødvendig antall personer / Number of persons required / Rekkomenderad antal personer**

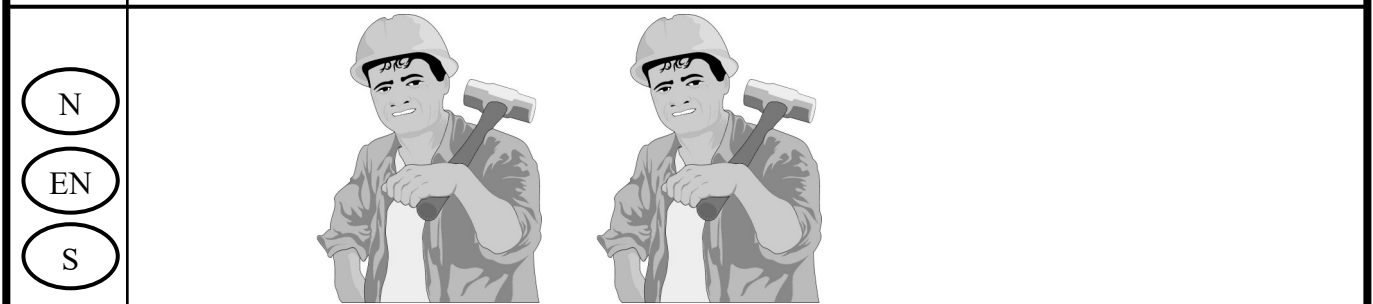

**Anbefalt arealbehov ved montering / Recommended working space / Rekkomenderad arealbehov vid montering**

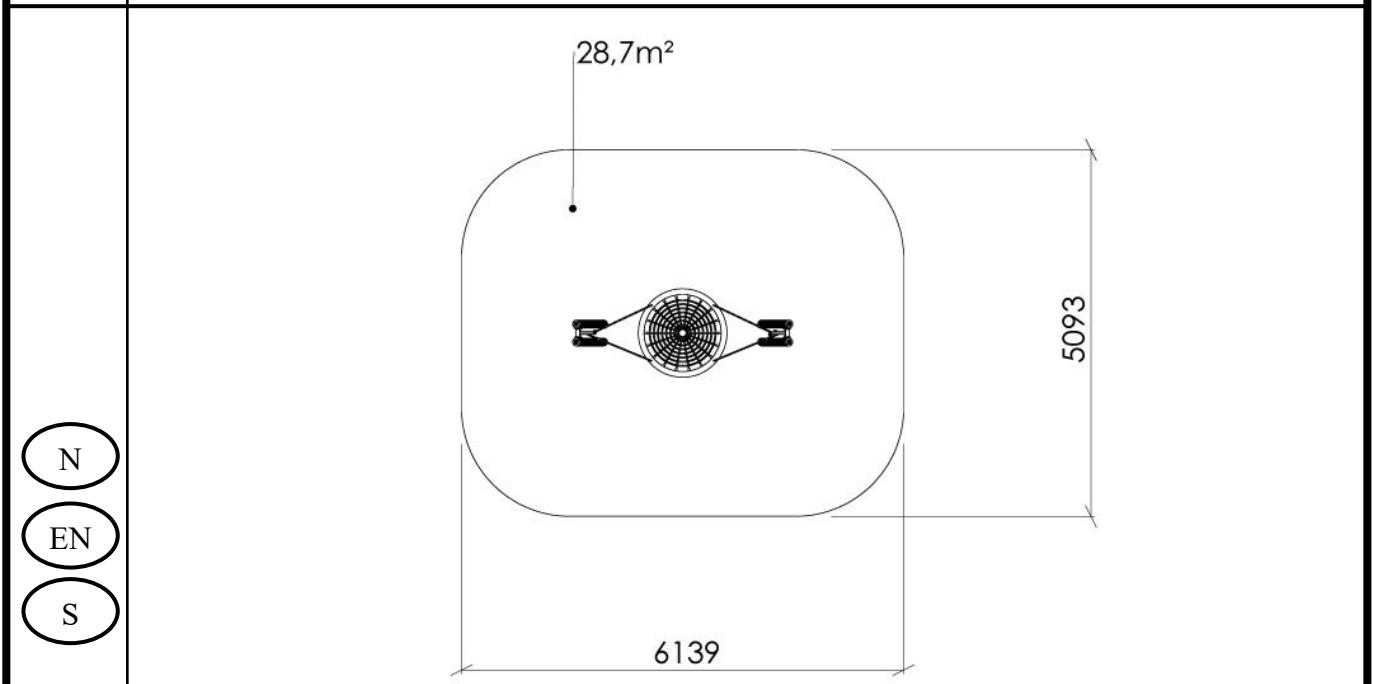

## Sikkerhetszone / Safety zone / Säkerhetszon

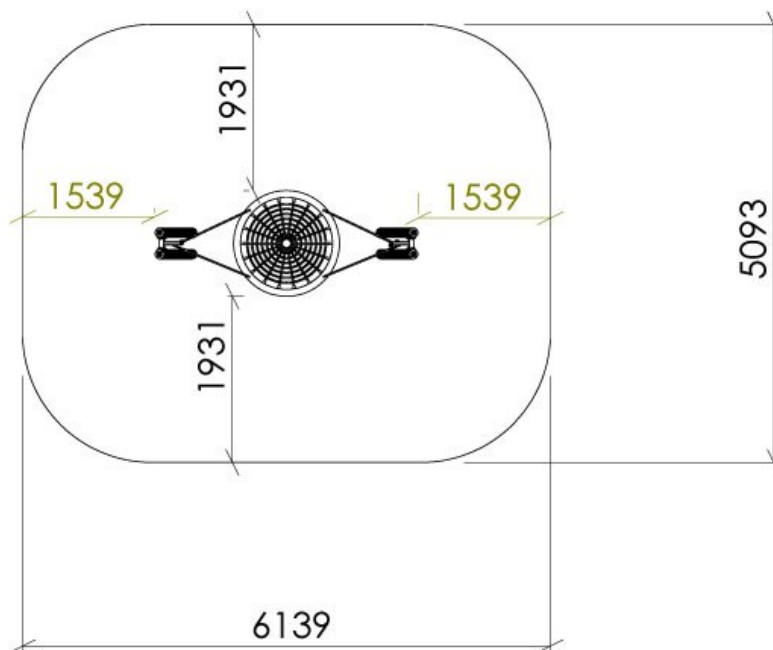

## Fallhøyder / Free height of fall / Fallhöjder

Fallhøyde = 1 meter

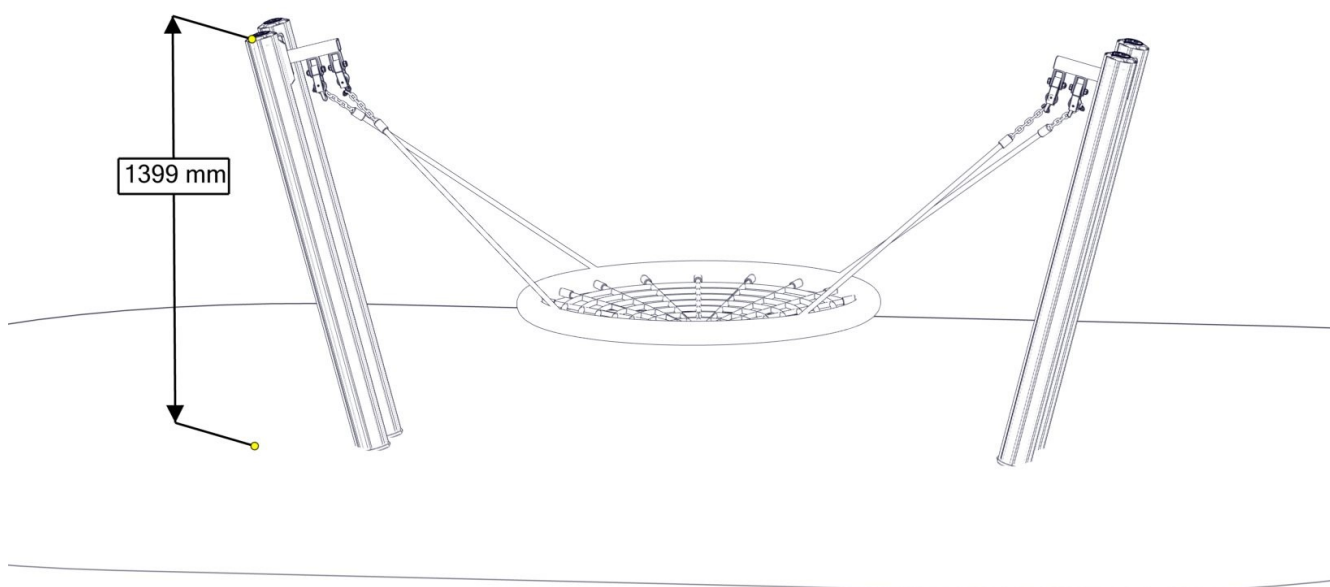

### Plassering av forankringer / Ground plan / Placering av förankringar

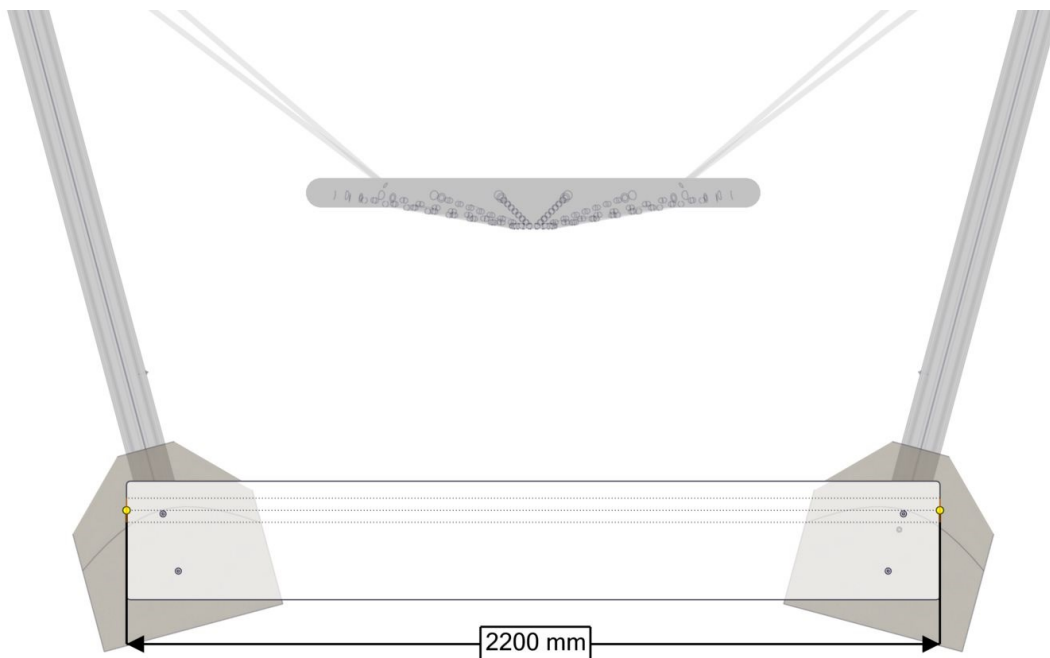
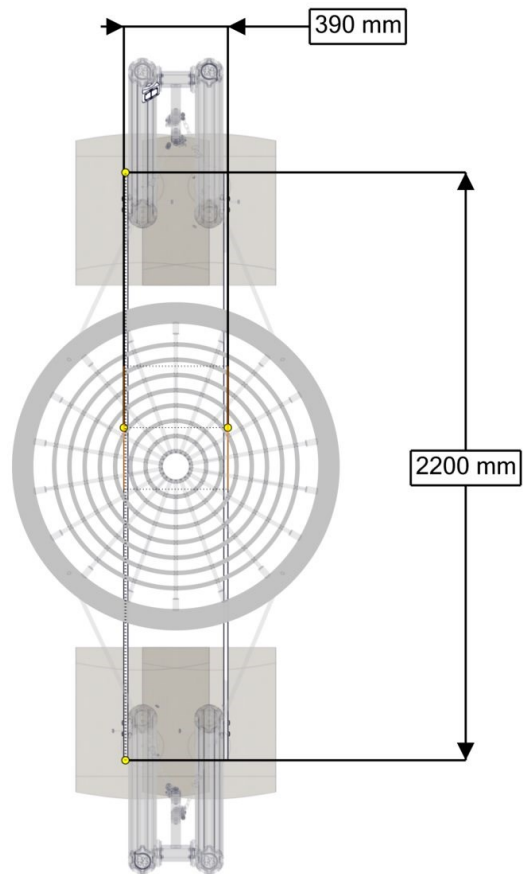

N

Bolten skrues HELT igjennom aluminiumen.  
Maks moment: 30Nm

EN

The bolt must be tightened in to the post, so that it pierces the aluminium  
Max torque: 30Nm

S



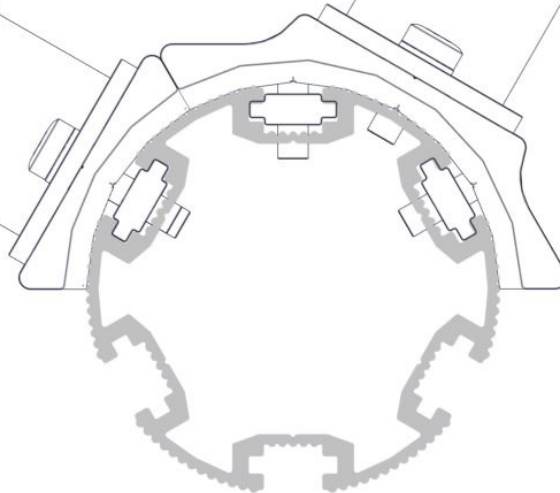

Bulten skuvas HELT genom aluminiumen.  
Maks vridmoment: 30Nm

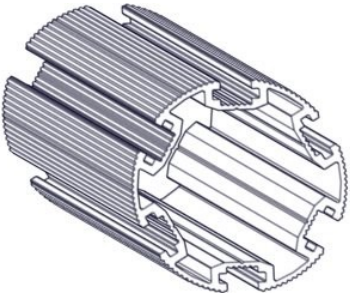
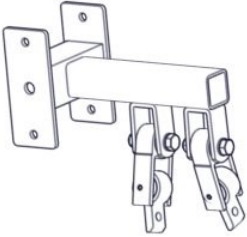

NO	Betongkvalitet	C25/30		
SE	Betongkvalitet			
EN	Concrete quality			
NO	Mengde betong	0,4	m <sup>3</sup>	
SE	Mängd betong			
EN	Amount of concrete			
NO	Fundament størrelse	0,5 x 0,5 x 0,4	m	
SE	Stiftelsestorlek			
EN	Foundation size			
NO	For sikkerhet må fundamentene med sand eller myk jord være minst 50% større i areal			
SE	För säkerheten måste grunden med sand eller mjuk jord vara minst 50% större i området			
EN	For safety, the foundations with sand or soft soil must be at least 50% larger in area			
NO	Tyngste element	50-105-618	27	Kg
SE	Tyngsta element			
EN	Heaviest element			
NO	Største element	SFA5126	2,05x Ø 0,11	m
SE	Största element			
EN	Biggest element			

**Boltepakker for / Boltpackage for / Bultpaket för**

Sign. \_\_\_\_\_

Mini fuglerede 81-151-611	Navn	Artnr/dimensjon	Ant	Lev
	Stolpe Ø110 L=2050 (1450-600) grå	SFA5126/2	4	
	Brakett minifuglerede Med montert oppheng Sort	01-151-117	2	
	Endelokk til stolpe Ø110	00-400-995	4	
	Minifuglerede 1000mm Inklusiv festemidler	50-105-618	1	
	Forankringplate minifugle- rede	07-400-110	2	
	Beslag 0 gr 150	07-150-022	4	



**Boltepakker for / Boltpackage for / Bultpaket för**

Sign. \_\_\_\_\_

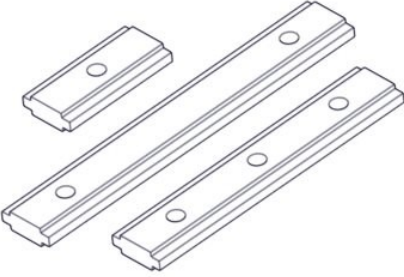
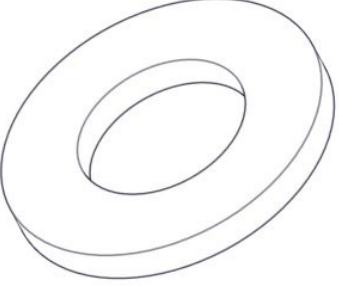
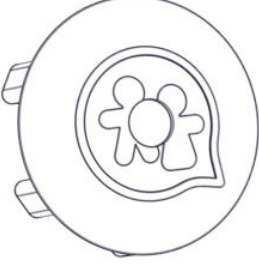
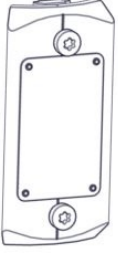
Mini fuglerede 81-151-611	Navn	Artnr/dimensjon	Ant	Lev
	Torx M8x30 Torx M8x35	04-000-030 04-000-035	8 8	
	Brikke 150 2xM8 Brikke 200 2xM8	04-060-151 04-060-200	4 4	
	Skive M8	04-050-008	8	
	Endelokk til stolpe Ø110 Med hull	00-400-994	4	
	Produktmerke Søve	07-500-500 (Se egen del- montering)	1	

**Fundamentering med betong // Foundation concrete // Förankring med betong**

(N)

Støtsand



(N)

Bakkenivå

(EN)

Ground level

(S)

Marknivå

(EN)

Safer surface

(S)

Stridsand

Ref NS-EN 1177

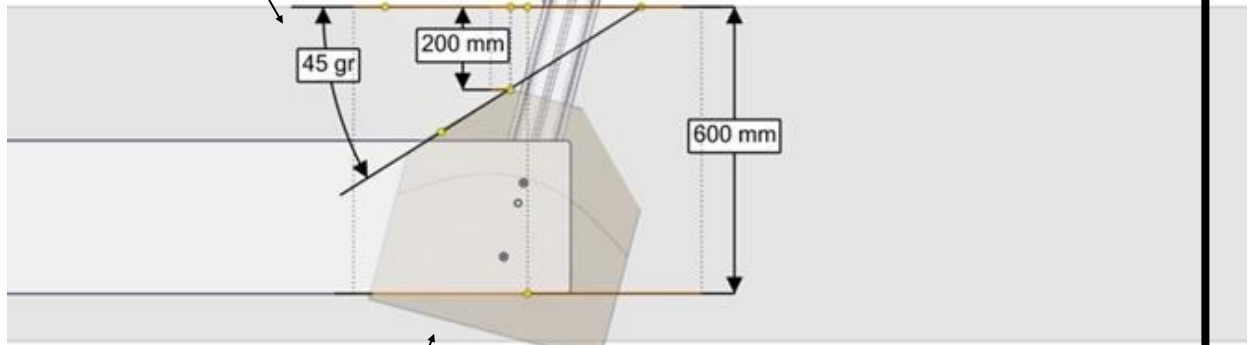

(N)

Komprimert masse.

betong

(EN)

Compressed mass.

concrete

(S)

Komprimerad massa.

betong

2x

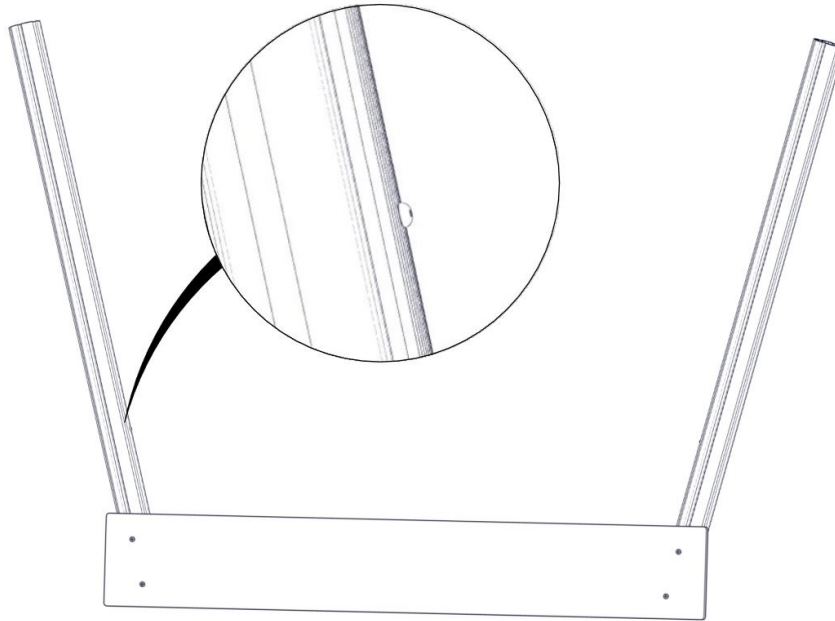

Part Name	Article nr.	Qty
Torx M8x30	04-000-030	4
Stolpe Ø110 L=2050 (1450-600)	SFA5126/2	2
forankeringsplate_minifuglerede_V2	07-400-110	1
Endelukk 110 med hull	00-400-994	2
Brikke 200 2xM8	04-060-200	2

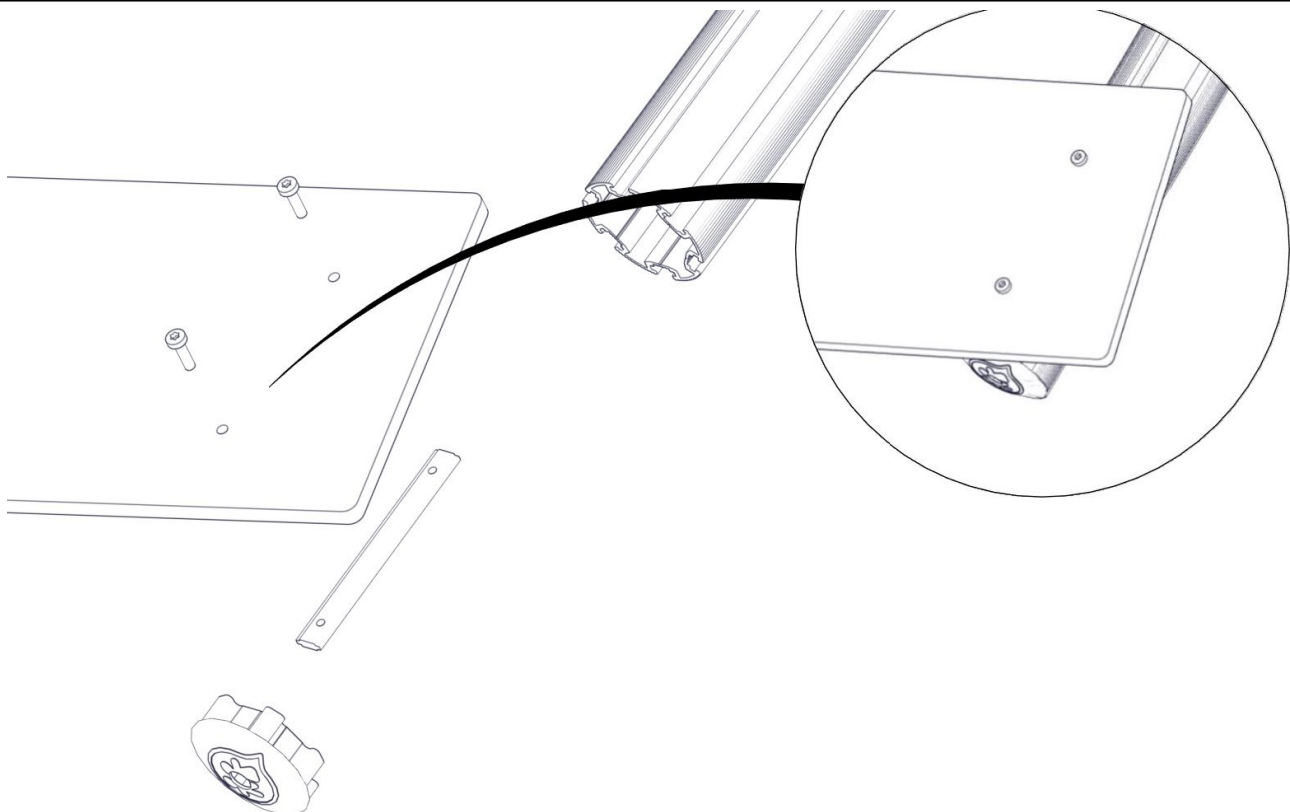

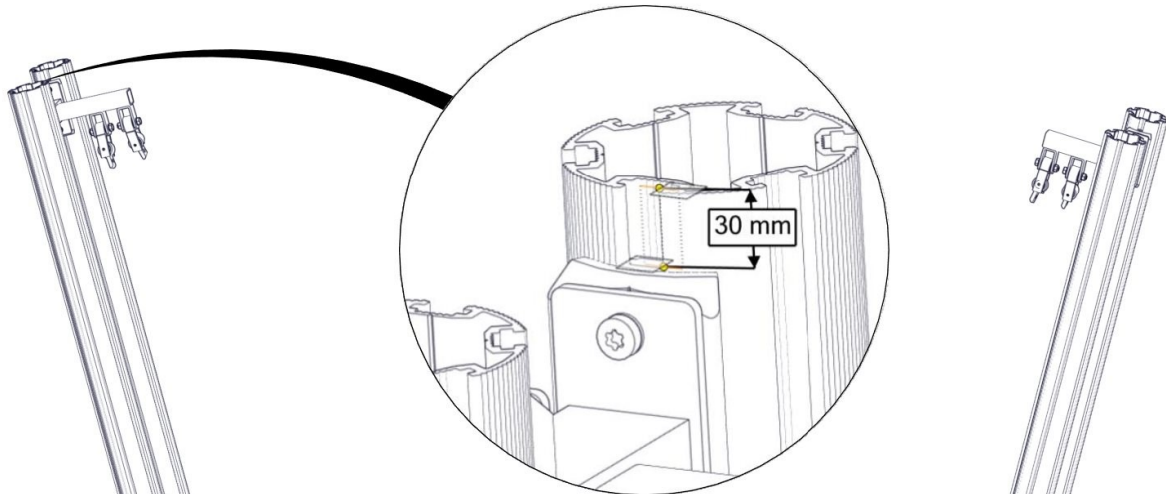

Part Name	Article nr.	Qty
Torx M8x35	04-000-035	8
Skive M8	04-050-008	8
Brikke 150 2xM8	04-060-151	4
Brakett Minifuglerede montert med oppheng	01-151-117	2
Beslag 0gr 150 2xhull	07-150-022	4

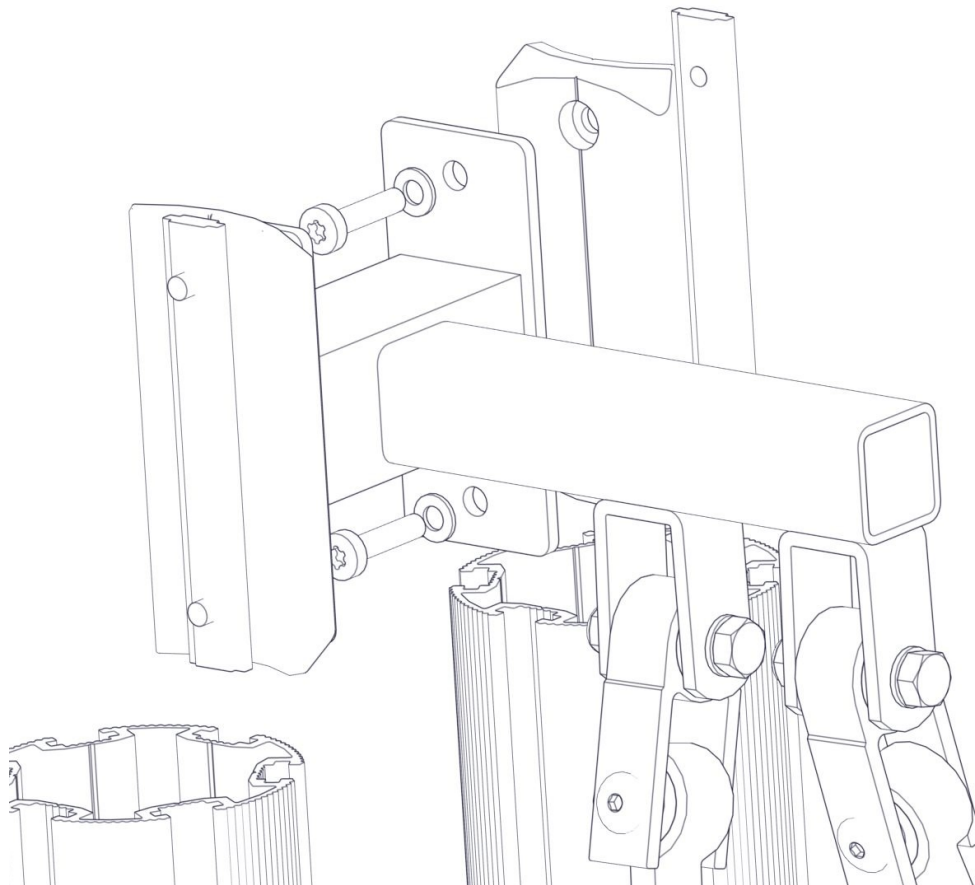

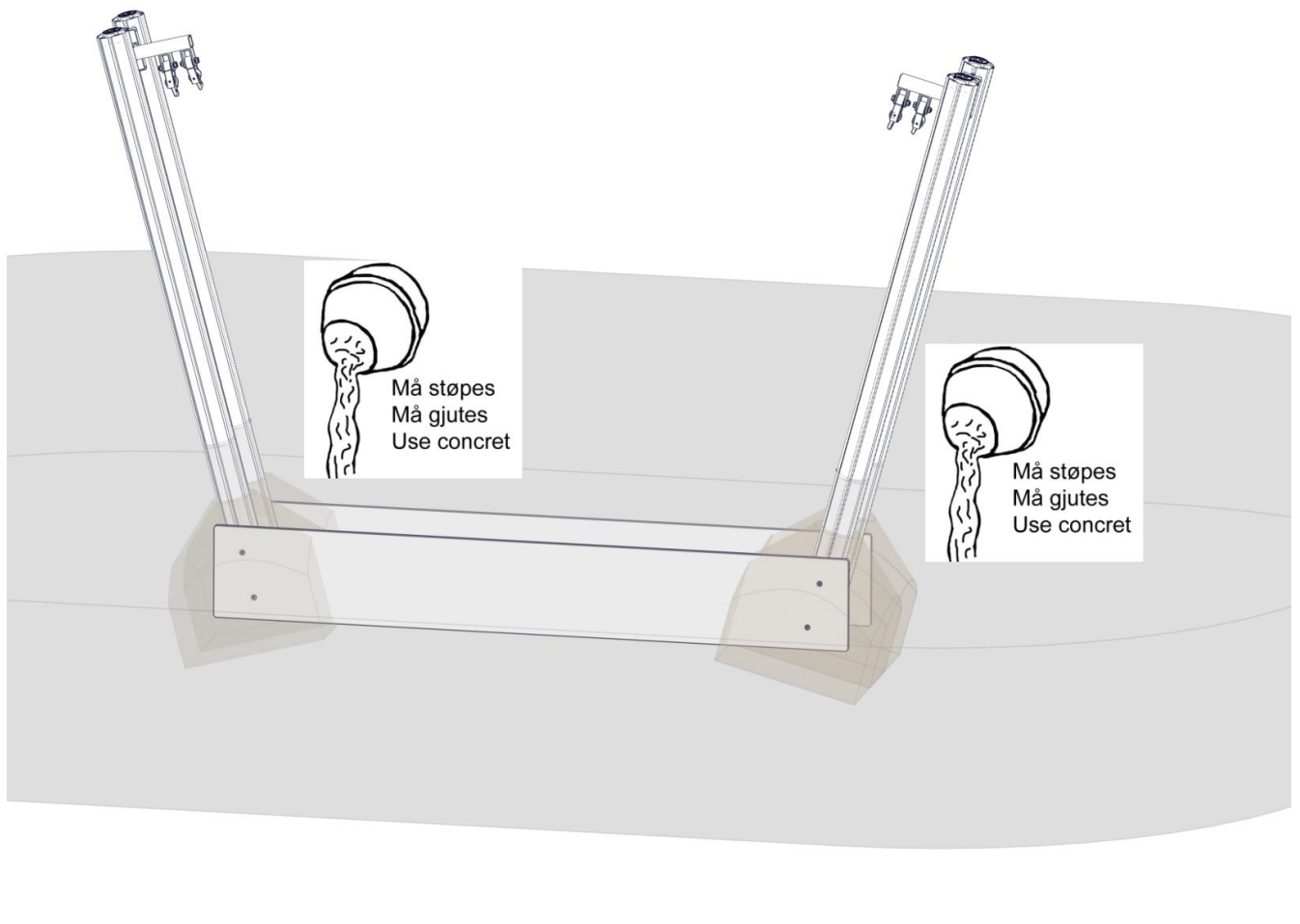
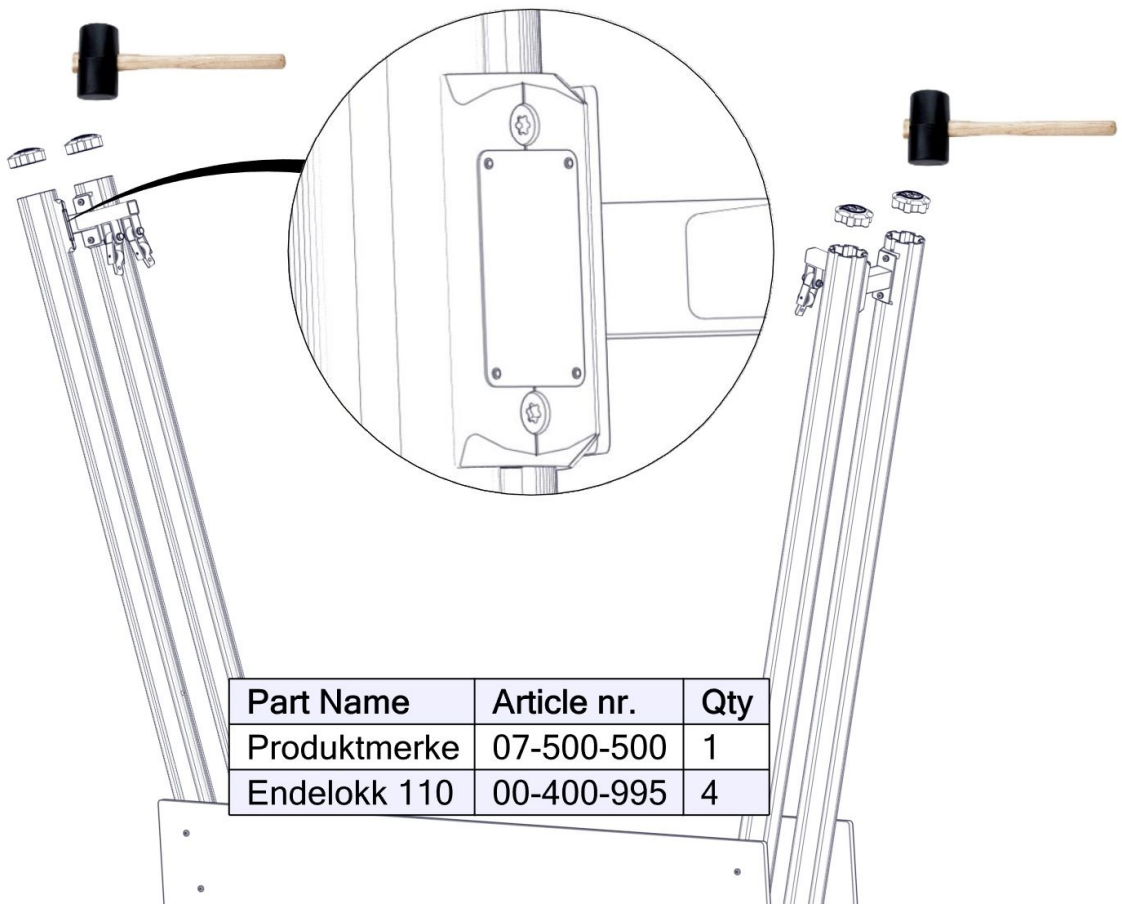

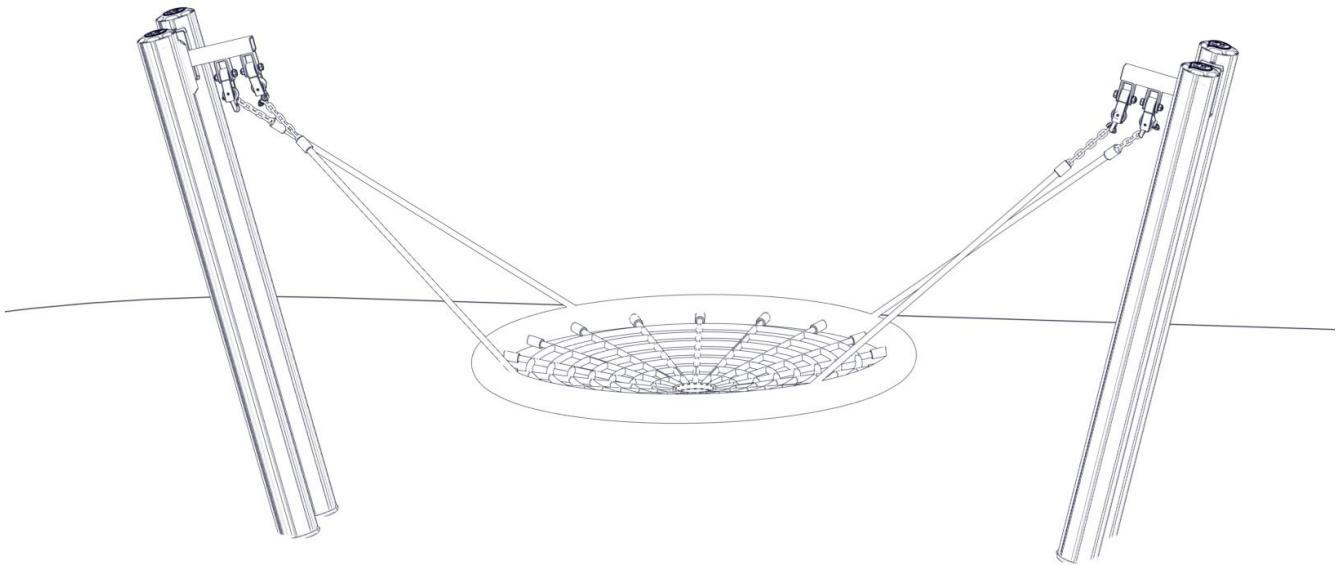

Part Name	Article nr.	Qty
Fuglerede 1000mm for minifugleredestativ	50-105-618	1

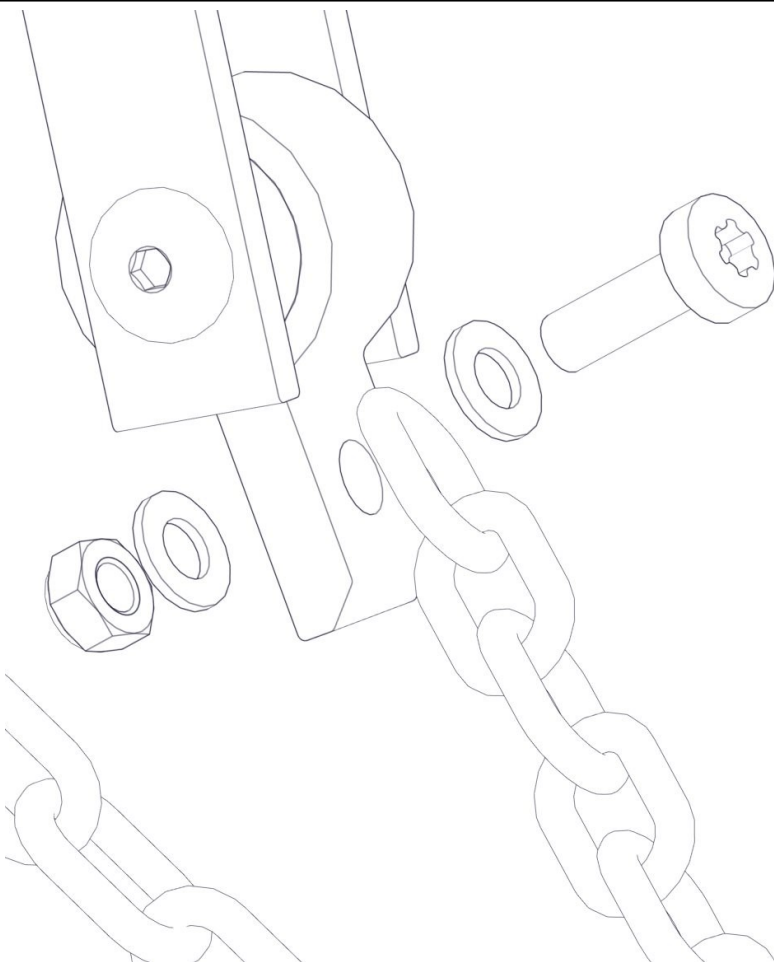





<b>Før utstyret tas i bruk / Before play begins / Innan lekredskapet tas i bruk</b>	
<b>N</b>	<ul style="list-style-type: none"> <li>● Påse at fallunderlag er utlagt i henhold til gjeldende regler eller vår anbefaling</li> <li>● Fjern alle monteringshjelpemidler ( rester av betong, planker, paller, plast, og lignende)</li> <li>● Før utstyret tas i bruk, burde man sjekke at det ikke er fare for at anorakksnorer og lignende som kan hekte seg fast noen steder på lekeapparatet. (Vedlagte snor med dobbe (kneledd) kan brukes til å sjekke at dette er i orden. Se vedlagte veiledning for bruk av denne. Dette gjøres for å oppdage eventuelle feilmonteringer.?)</li> <li>● NB! Bør stå i 2-3 dager før bruk</li> </ul>
<b>EN</b>	<ul style="list-style-type: none"> <li>● Make sure the area and depth of safer surfacing are according to the current standard, or to the manufacturer's recommendation</li> <li>● Make sure all tools and surplus materials are removed before play begins</li> <li>● PS! When complete, allow 2-3 days for the concrete to set before use</li> </ul>
<b>S</b>	<ul style="list-style-type: none"> <li>● Kontrollera att fallunderlag är utlagt enligt gällande regler eller vårt rekommendation</li> <li>● Ta bort alla monteringshjälpmedel (rester av betong, plankor, pallar, plast och liknande)</li> <li>● Innan lekredskapet används, kontrollera att anoracksnoddar eller kläder/delar av kläder eller liknande inte kan fastna i några delar på redskapet. (Den bipackade "knävringen" kan man med fördel användas för denna kontroll.</li> <li>● Detta görs för att upptäcka eventuella felmonteringar.)</li> </ul>



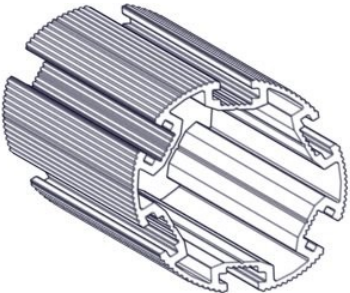
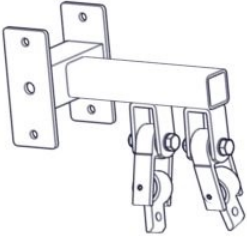

**Boltepakker for / Boltpackage for / Bultpaket för**

Sign. \_\_\_\_\_

Mini fuglerede 81-151-615	Navn	Artnr/dimensjon	Ant	Lev
	Stolpe Ø110 L=2050 (1450-600) grå	SFA5126/2	4	
	Brakett minifuglerde Med montert oppheng Sort	01-151-117	2	
	Endelokk til stolpe Ø110	00-400-995	4	
	Minifuglerede 1000mm Inklusiv festemidler	50-105-618	1	
	Forankringplate minifugle- rede	07-400-110	2	
	Beslag 0 gr 150	07-150-022	4	

**Boltepakker for / Boltpackage for / Bultpaket för**

Sign. \_\_\_\_\_

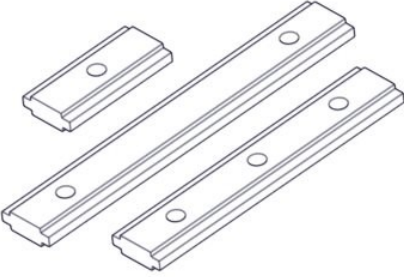
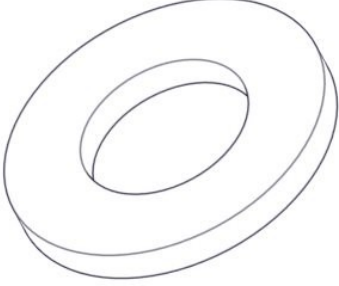
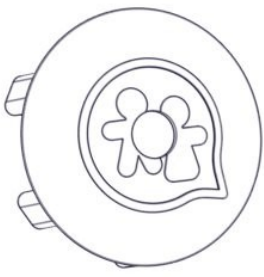
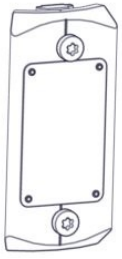
Mini fuglerede 81-151-611	Navn	Artnr/dimensjon	Ant	Lev
	Torx M8x30 Torx M8x35	04-000-030 04-000-035	8 8	
	Brikke 150 2xM8 Brikke 200 2xM8	04-060-151 04-060-200	4 4	
	Skive M8	04-050-008	8	
	Endelokk til stolpe Ø110 Med hull	00-400-994	4	
	Produktmerke Søve	07-500-500 (Se egen del- montering)	1	

MTK: 12-11-2021

Endret navn fra 50-151-605 til 81-151-611