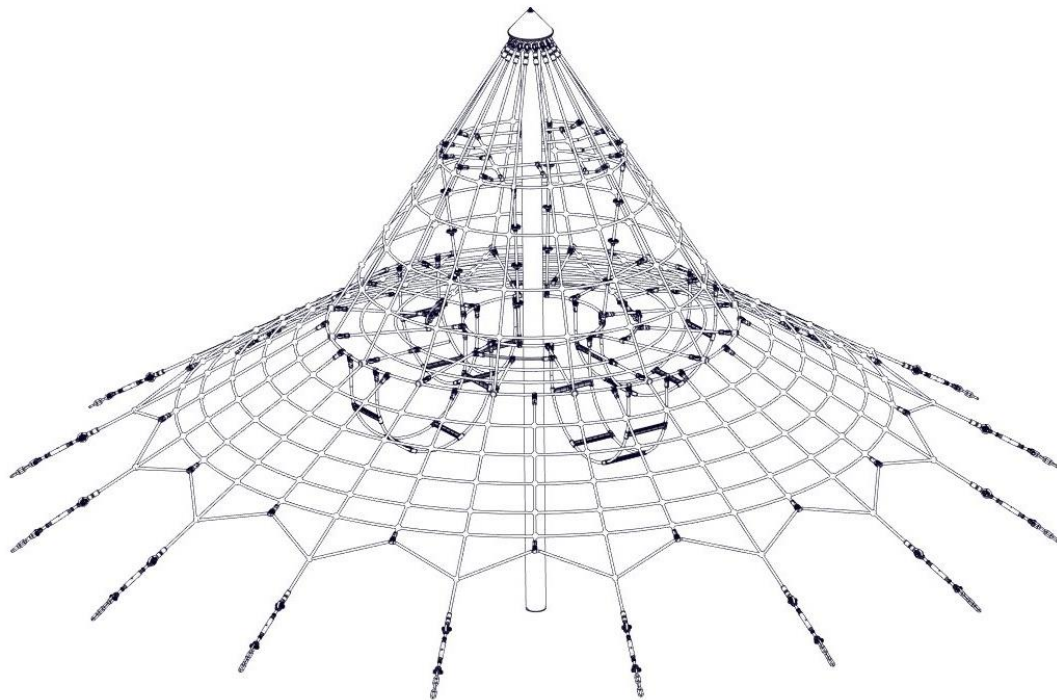


A Assembly instruction Midi Cheops pyramid, Art. 4643-2B to set into concrete

Attention! Only use the assembly instructions included in the scope of delivery for the assembly, installation and maintenance of the respective equipment!



Operator: _____

Location: _____

Revision history

Revision 0 – 2005-09-01

The first allowed version

Assembly instruction

Revision 17 – 2023-01-19 FH

Außenfundament 700x700x500

All rights reserved

© Copyright 2003 Huck Seiltechnik GmbH

Contents

A	Assembly instruction Midi Cheops pyramid (registered design) Art. 4643-2B to set into concrete	1
1	Introduction Assembling	1
2	Datasheet Midi Cheops pyramid, (registered design) article 4643-2B	3
3	Delivery contents (parts list with part numbers).....	5
4	Erection instructions.....	10
5	Screw locking device !	11
6	Post installation checks.....	19
B	Maintenance instructions Midi Cheops pyramid (registered design) Art. 4643-2B to set into concrete	21
7	Introduction Maintenance.....	23
8	General maintenance information	24
9	Regular maintenance	27
10	Maintenance timetable	28
11	Monthly maintenance	29
12	Quarterly maintenance.....	29
13	Half yearly maintenance.....	29
14	Annual maintenance.....	30
15	Maintenance printout	31
16	Hand over document	33

List of Tables

Table 3-1: Delivery contents, in words	5
Table 3-2: Delivery contents, in symbols	6

1 Introduction Assembling

1.1 General information

This equipment should be installed, inspected, maintained and operated in accordance with EN1176-7 guidelines.

Before installation work commences, please check that you have all of the equipment and fixation components in the parts list provided (see Tables 3-1 and 3-2).

Please consider that the installation has to be carried out only on even terrain (max. Slope up to 3%).

Any spare parts that may be required can be obtained directly from your supplier.

Please do not hesitate to call your supplier if you have any problems during installation or in case of any other questions.



Following installation, complete assembly instructions, maintenance instructions and a maintenance record must be sent to the operator who must confirm receipt in writing. See the last page of this document.



All nuts and bolts are hot-dip galvanised or stainless steel. One of the characteristics of stainless steel is that uncontrolled cold welding may occur when the nuts are tightened. To prevent this, it is necessary to spray the nuts and bolts with Teflon spray or another similar lubricant.

We hereby confirm that this play equipment has been tested and certified in accordance with the play equipment standard EN 1176.

Drawings / Views

All optical drawings are showing only the measurements/dimensions and are no mandatory technical views of the complete item.

We reserve the right to change technical details of our articles which are serving for the further development of our articles and are reasonable for the customer.

Measurement tolerances

Because of the properties and characteristics of the components, minor measurement tolerances compared to the indication on the sketches are possible. This concerns all shown measurements except the foundation measurements resp. measurements below upper edge ground level/play area.

2 Datasheet Midi Cheops pyramid, Article 4643-2B

1. Minimum space: Ø 9.60 m
 Equipment room: Ø 8.35m
 Equipment height: 4.22 m
 Fall height: 1.50 m
 Fall protection area: 72.4 m²
2. Required safety surface:

Surface material	Description mm	Minimum thickness of layer mm	Maximum height of fall mm
Topsoil grass			<= 1000*
Chipped bark	20 – 80 grain size	300	<= 2000
		400	<= 3000
Wood chippings	5 – 30 grain size	300	<= 2000
		400	<= 3000
Sand	0.2 – 2 grain size	300	<= 2000
		400	<= 3000
Gravel	2 – 8 grain size	300	<= 2000
		400	<= 3000
Other ground materials	As recommended by manufacturer		

3. Name and overall dimension of the largest component:
 Steel post ø 159 mm; length 5.00 m
4. Name and weight of the heaviest component:
 Steel post (1 pallett), approx. 106 kg
5. Intended age group: 6 years and over

Please note that this equipment is set in concrete.

Concrete: B25 – C20/25

Required concrete: approx. 4.3 m³

Foundations/area to be excavated:

Top edge of concrete 40 cm below ground level

1 x 0.80 m x 0.80 m x 0.60 m (height),
 total depth 1.10 m including 10 cm drainage

16 x 0.70 m x 0.70 m x 0.50 m (height),
 total depth 1,10 m including 10 cm drainage



Round off foundation edges (min.R = 100 mm)! Sizes of foundations are “4-5” (natural ground).

Soil class 4: soft to medium plasticity, interleave bound, with minor portion of stone (portion < 30% with bigger diameter of 63 mm grain size).

Soil class 5 : ground with soil class 3 and 4 with big portion of stones (portion > 30% with bigger diameter of 63 mm grain size).

In case of sandy and soft soils, the surface measure of foundations have to be enlarged for about 50% !

6. Assembly time, once foundations complete: approx. 3 hours.
Required assistance: 3 people.
7. Any spare parts which may be required can be obtained directly from your supplier
8. **We hereby confirm that this item of play equipment has been tested and certified in accordance with the play equipment standard EN 1176.**

3 Delivery contents (parts list with part numbers)


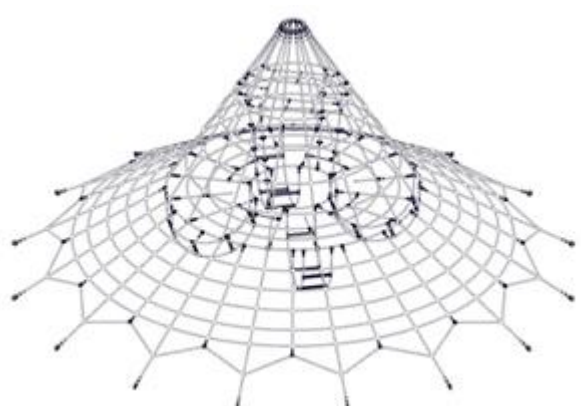
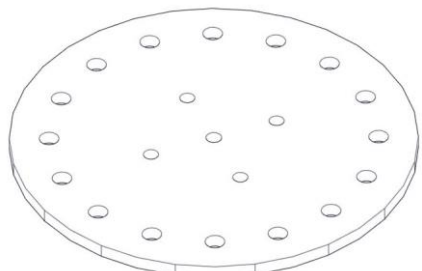
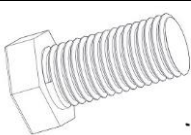
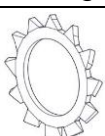
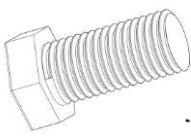
3.1 In words

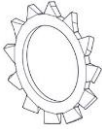

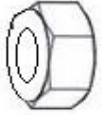
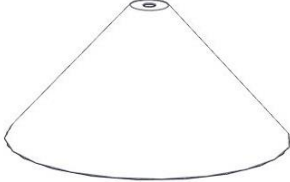



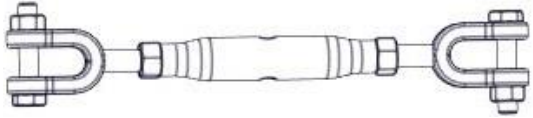
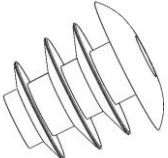
Table 3-1: Delivery contents, in words

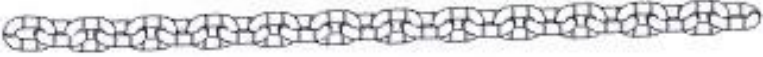
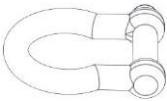


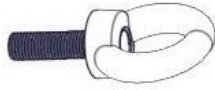
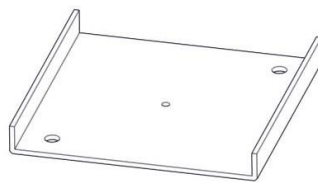
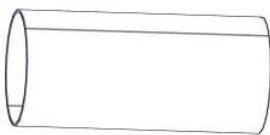
Pos.	Quantity	Element / Description	Size	O.K.	Missing
1	1	Steel post, galvanised	Ø 159 mm; 5.00 m long		
2	1	Play element (netting completely preassembled)			
3	1	Cover plate, galvanised	Ø 360 mm x 12 mm		
100	4	Hexagon bolts	M12 x 30, galvanised		
101	4	Tooth lock washers	M12, galvanised		
102	16	Hexagon bolts	M16 x 30, galvanised		
103	16	Tooth lock washers	M16		
104	1	Threaded rod	M16 x 165 mm		
105	1	Hexagon nut	M16, VA		
106	1	Red cover	Ø 375 mm, 140 mm high		
107	1	Washer	17, DIN 9021, VA		
108	1	Stop nut	M16, VA		
109	1	Black cap	For M16		
110	16	Turnbuckles	M16, hot-dip galvanised		
110a	16	Lamella plugs			
111	16	10 mm chains	Approx. 1.30 m long		
112	16	Welded shackles (for ground pins)	10 mm, galvanised		
113	16	eye bolt	M12 x 250 mm		
114	2	Loctite			
115	1	Ring bolt (for erecting the post)	M16, galvanised		
Gew.pl	1	Steel Anker Plate	500 x500mm		
	1	Drainpipe (to be provided by customer)	Approx. Ø 300 x 700 mm long		
10	1	Paintbrush	Customer request		
11	1	Tin of paint	Customer request		


3.2 In symbols

Table 3-2: Delivery contents, in symbols

Pos.	Quantity	Symbol
1	1	 Ø 159 mm, 5,00 m long
2	1	
3	1	 Ø 360 mm x 12 mm
100	4	 M12 x 30 mm galvanized
101	4	 M12 galvanized
102	16	 M16 x 30 mm, galvanized

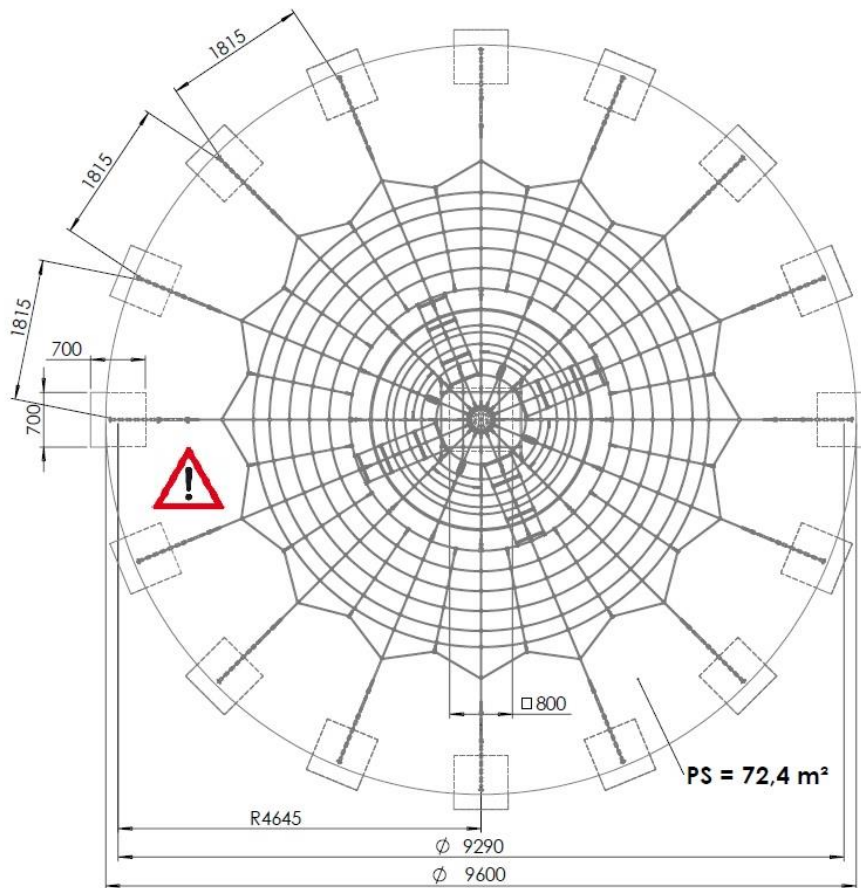
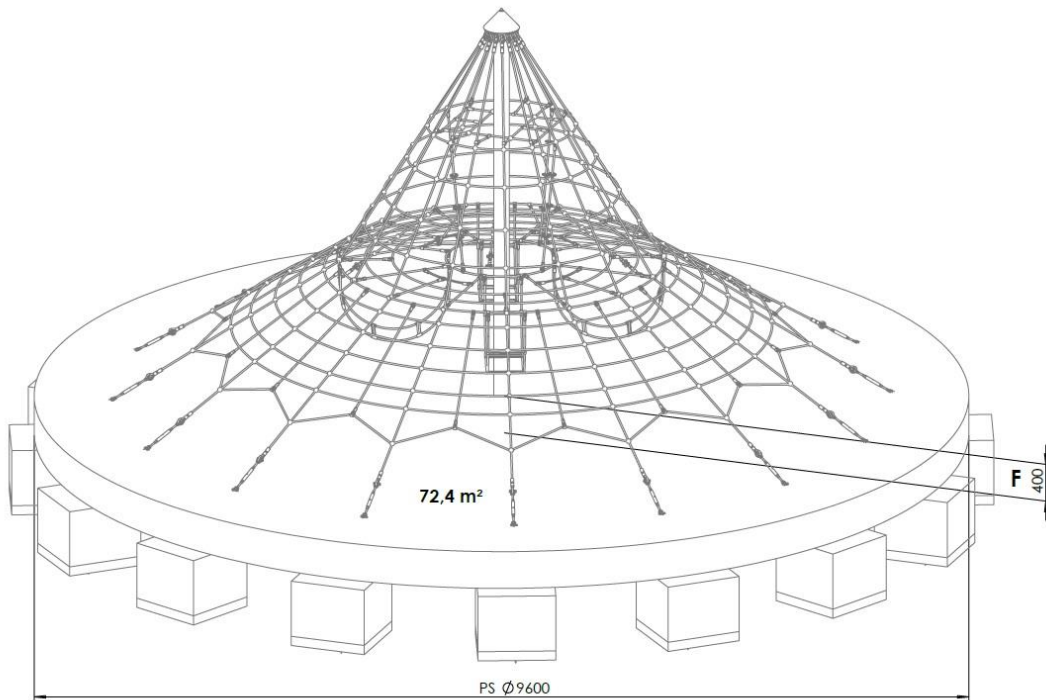
Pos.	Quantity	Symbol
103	16	 <p>Washer for M16</p>
104	1	 <p>Threaded rod, M16 x 165 mm, VA</p>
105	1	 <p>M16 VA</p>
106	1	 <p>Mast hood, Ø 375, 140 mm high</p>
107	1	 <p>Washer 17er DIN9021 VA</p>
108	1	 <p>Stop nut</p>
109	1	
110	16	 <p>16er Turnbuckle</p>
110a	32	 <p>Lamella plugs</p>

Pos.	Quantity	Symbol
111	16	 <p>10er Chain 1,30 m</p>
112	16	 <p>6er Shackle curved</p>
113	16	 <p>Tent peg, 300 mm long</p>
114	2	 <p>Loctite 3 ml</p>
115	1	 <p>M16 Ring screw</p>
Gew.pl	1	 <p>steel plate 500 x 500 mm</p>
KNR	1	 <p>Plastic pipe (by the customer)</p>

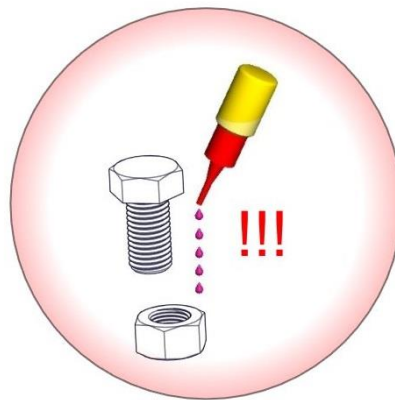
	Version: "Midi" Cheops Pyramid
AB	The legally prescribed setting times must be observed!
AE	Anchor chains are secured in the ground with ground pins.
a.Einb.	Chain set in concrete in the foundations
D	C20/25 (B25) concrete (for foundations) Concrete required: ~4,3 m³
de	Dismantle
ek	Chains may need to be shortened during assembly.
F	Fall protection
Gew.pl.	Steel Anker Plate
G	Drainage layer
KNR	Pipe (e.g. concrete or PVC drainpipe) Ø 300 mm, 0.70 m long, to be supplied by the customer
LRSA	Fill space between pipe and steel post with sand.
ML	Post height above playing level
O.K.	Upper edge of playing level
PN	Place the netting over the pipe with the underside on the foundations.
PS	Space requirement including safety zone ~72,4 m²
R	Radius
ÜKV	Spanner locks cross-tension
VO	Preassembled
Wbu.	After tightening and before installing the fall protection, plug the bores in the threaded sleeve of the turnbuckles on site.
	Round off foundation edges (min.R = 100 mm)! Sizes of foundations are designed for soils class "4-5" (natural ground). Soil class 4: soft to medium plasticity, interleave bound, with minor portion of stone (portion < 30% with bigger diameter of 63 mm grain size). Soil class 5 : ground with soil class 3 and 4 with big portion of stones (portion > 30% with bigger diameter of 63 mm grain size). In case of sandy and soft soils, the surface measure of foundations have to be enlarged for about 50% !

See drawing!

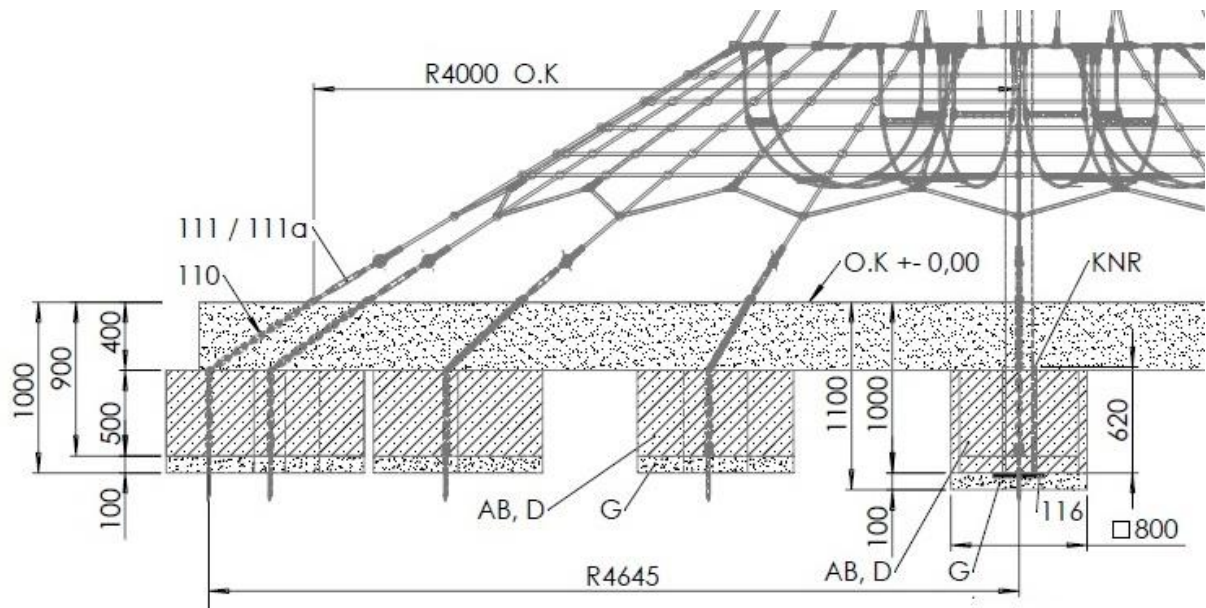
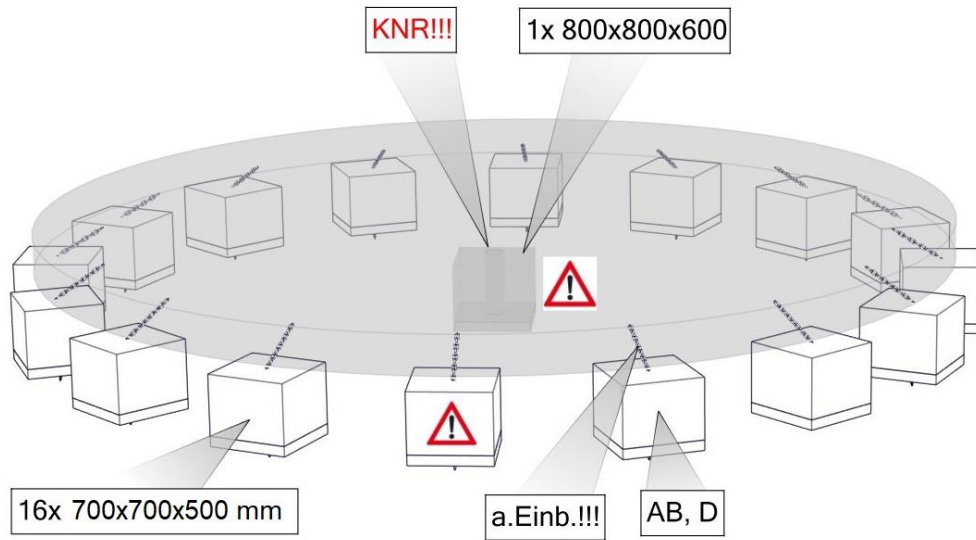
4 Erection instructions

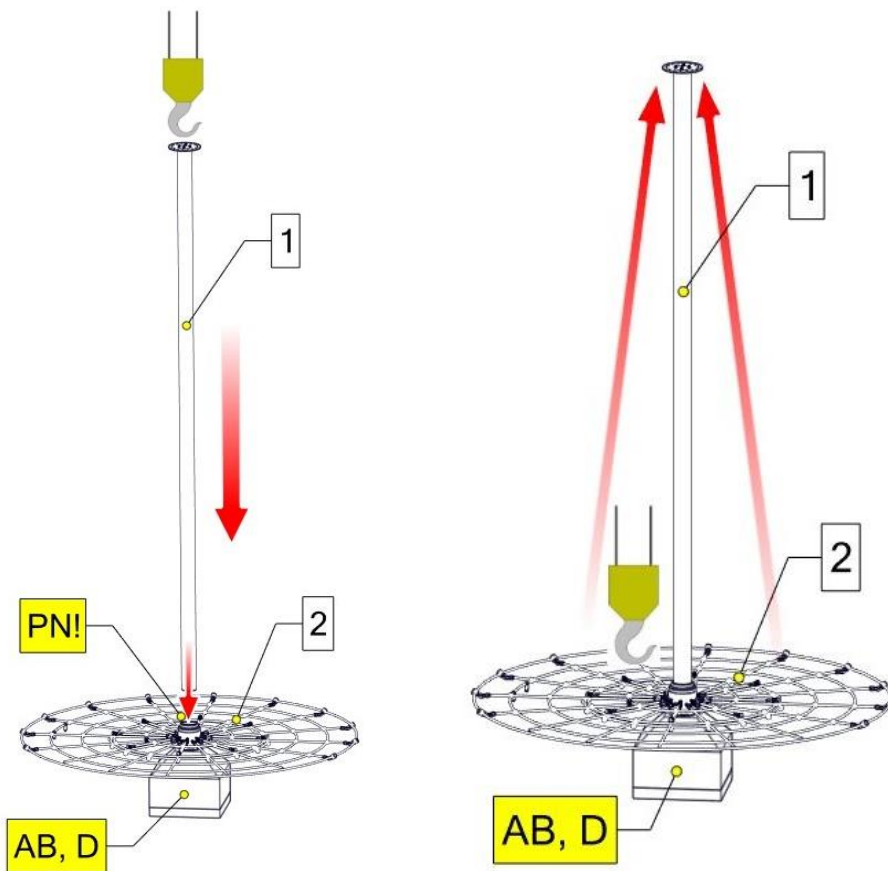
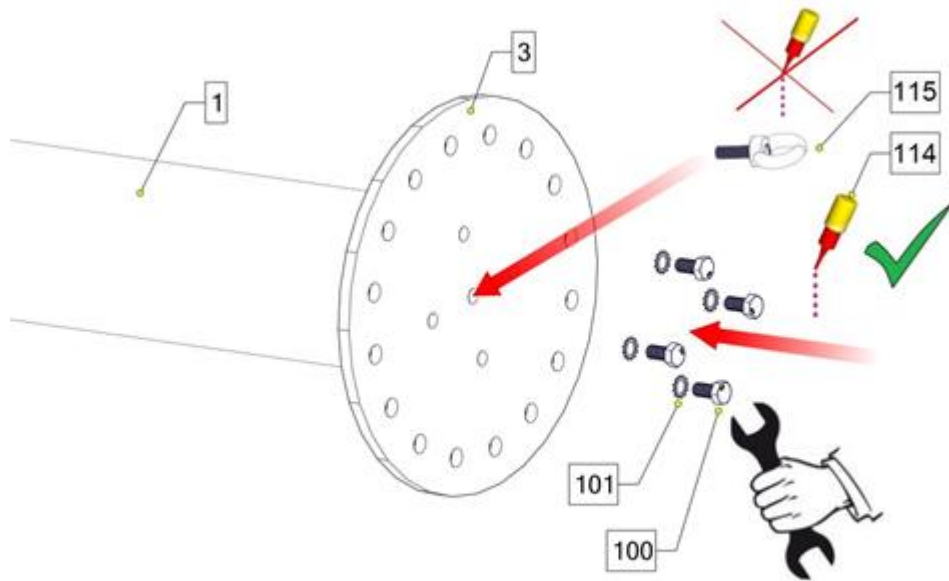


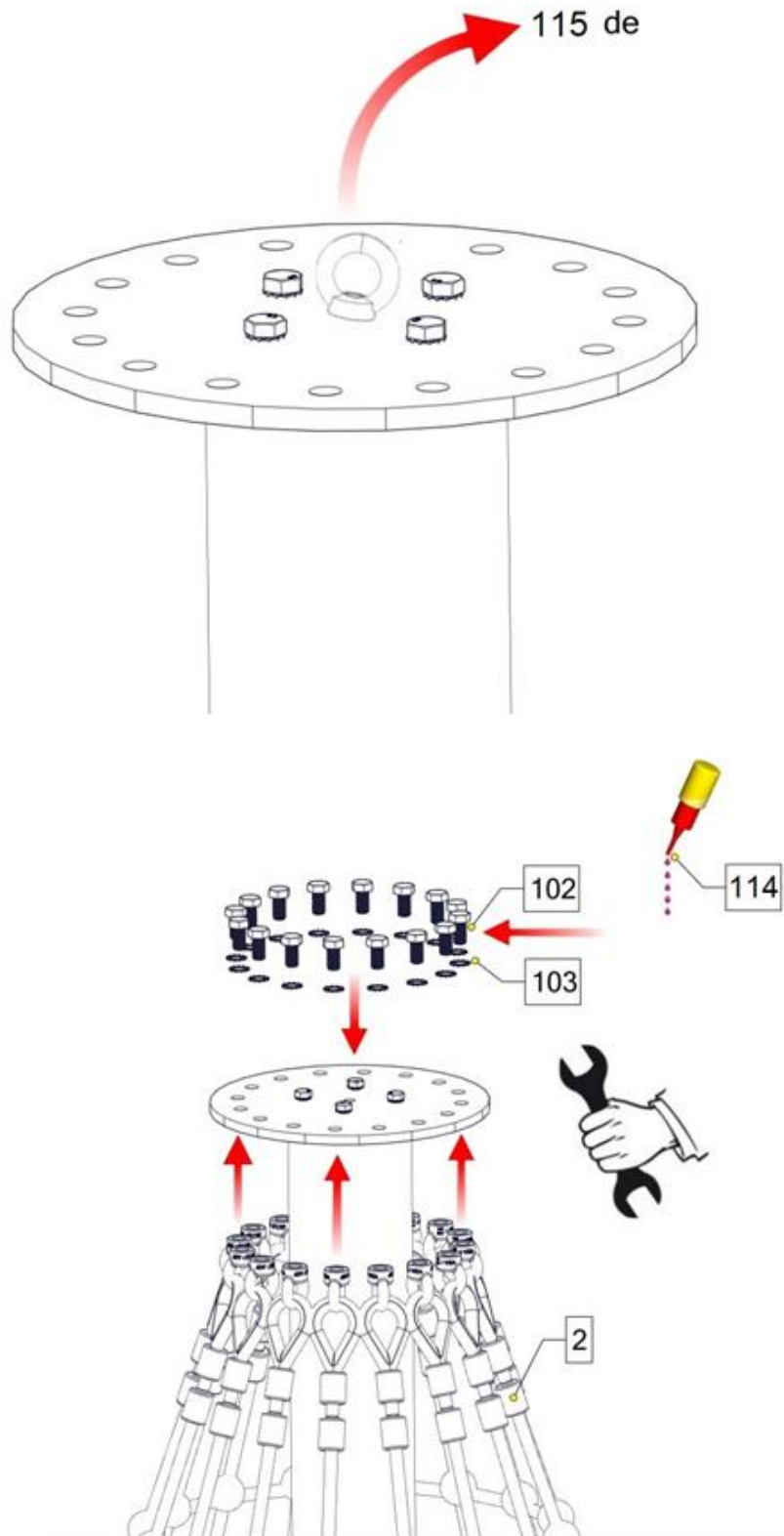
Screw locking device

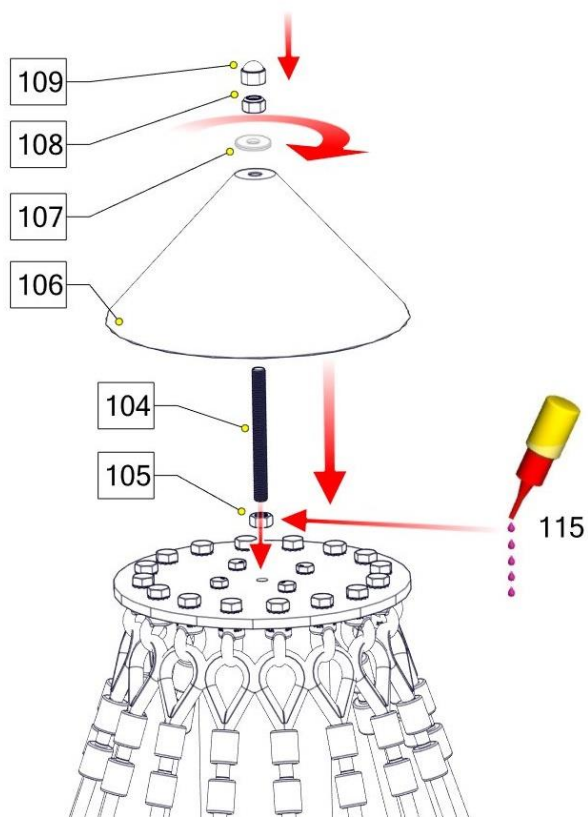
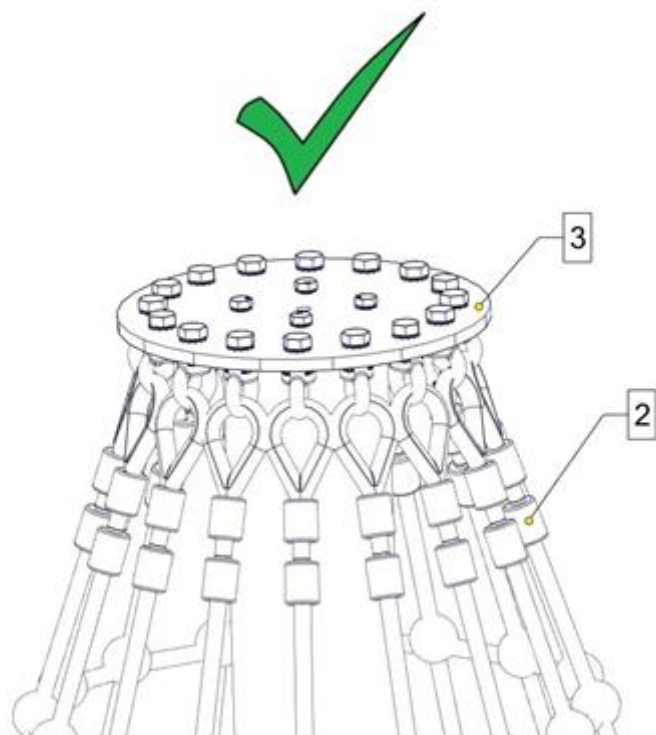


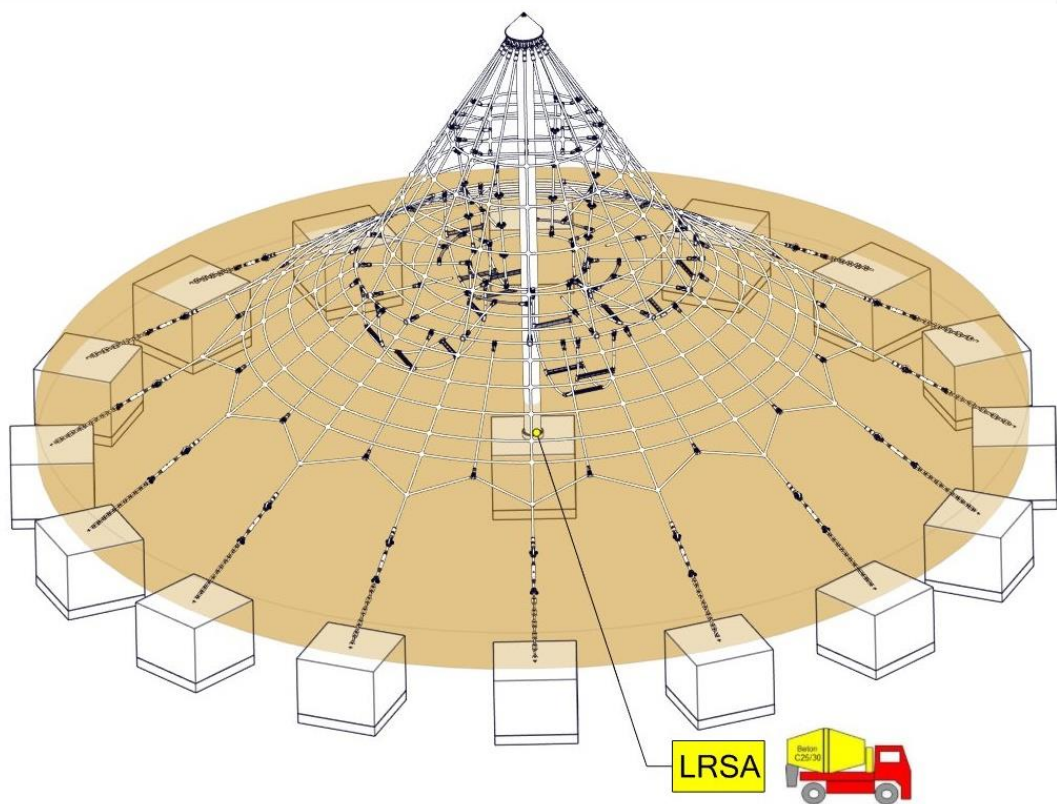
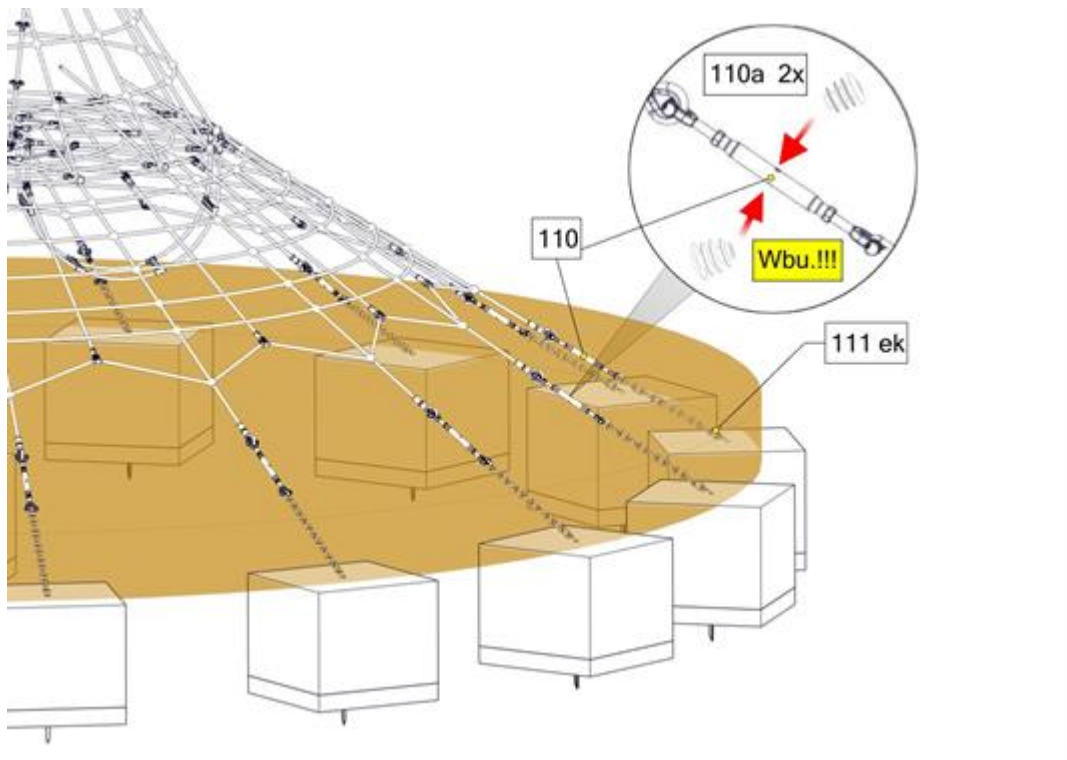
**glue all screws, nuts and sleeves with loctite
(not less than 5 drops !)
(except for lock nut)**

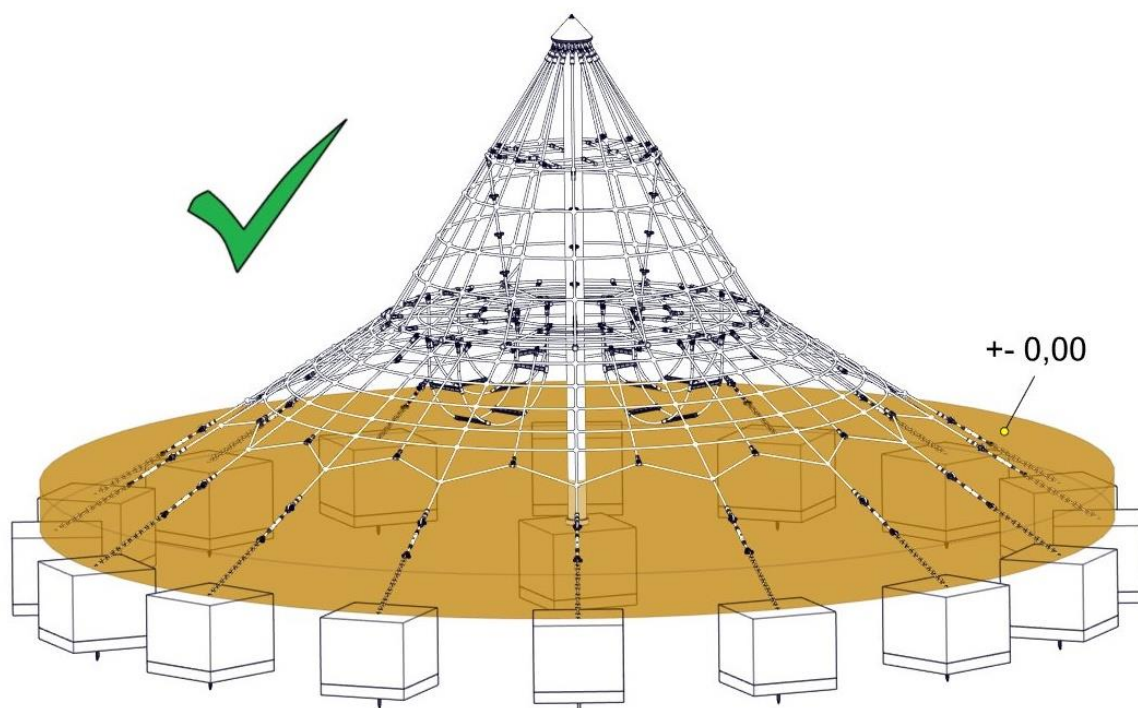
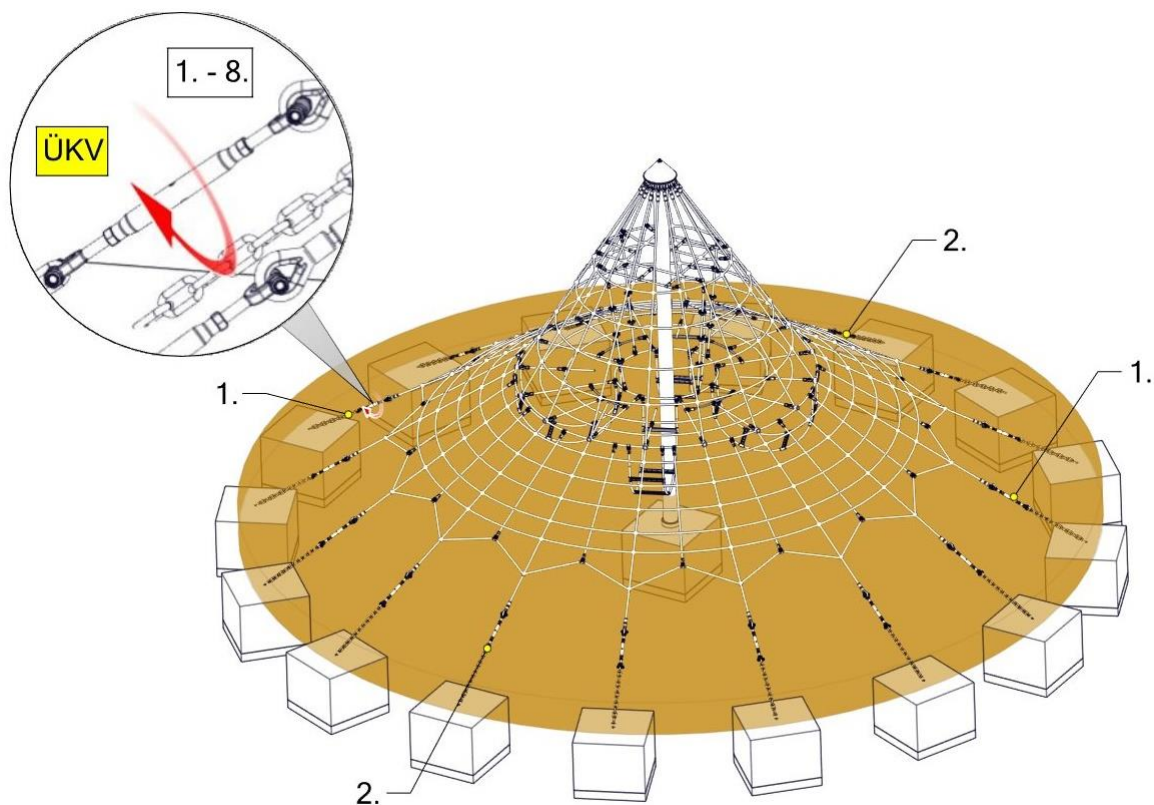












5 Post installation checks



If the equipment has not been installed safely, you must ensure that the public is prevented from using it.

5.1 Marking filler depth

Labelling the posts to show the depth of material provided as fall protection (i.e. loose filler).

5.2 The equipment has not been installed safely in the following cases:

Safe equipment installation is not complete.

The protective surface has not been installed yet.

Appropriate maintenance work cannot guarantee operational safety.

5.3 Removal of all assembly aids

Please make sure that all assembly aids have been removed from the playing area. The equipment must not be approved for use until this check has been made.

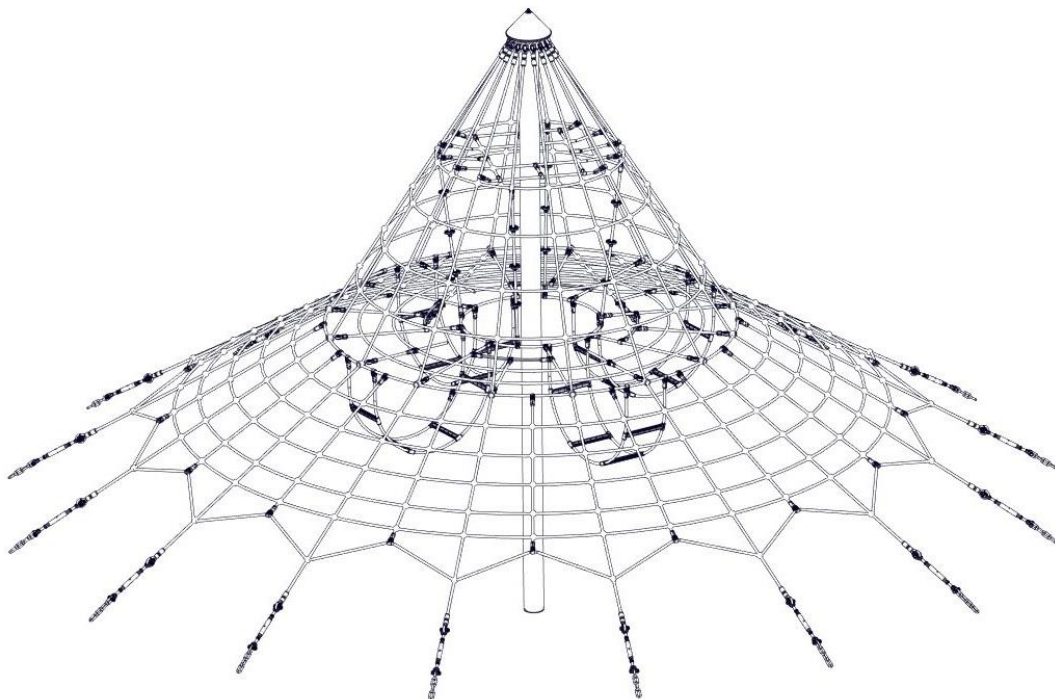
5.4 Information about inspection of the equipment before it is used for the first time

There are no special inspection requirements to be met before the equipment is used for the first time.

5.5 Retighten bolts

After one week of play, please retighten all bolts again. Later upon respective maintenance.

B Maintenance instructions Midi Cheops pyramid, Art. 4643-2B to set into concrete



Revision history

Revision 0 – 2005-09-01

The first allowed version

Maintenance instruction

Revision 17 – 2023-01-19 FH
Außenfundament 700x700x500

All rights reserved

© Copyright 2003 Huck Seiltechnik GmbH

6 Introduction Maintenance

6.1 General informations

This equipment should be installed, inspected, maintained and operated in accordance with EN 1176-7 guidelines.



Please note: Providing any necessary repairs are carried out, a piece of play equipment that is inspected regularly cannot become so damaged that it is dangerous.

Any spare parts which may be required can be obtained directly from your supplier.



This equipment should only be assembled, maintained and repaired by **persons with the necessary expertise**.
A copy of the inspection record should be given to the operator, who must confirm receipt.

**This maintenance instruction is based on the standard
“EN 1176-1:2017”.**

7 General maintenance information

7.1 Maintenance intervals

Maintenance intervals are based on average use. Please note that more frequent inspections and/or maintenance are required if the play equipment is subject to intensive use.

7.2 Inspection frequency

The frequency of inspections must be based on actual use. Factors that affect frequency include vandalism, location (e.g. coastal proximity), air pollution and the age of the equipment.

7.3 Maintenance products and procedures

All nuts and bolts are hot-dip galvanised or stainless steel. One of the characteristics of stainless steel is that uncontrolled cold welding may occur when the nuts are tightened. To prevent this, it is necessary to spray the nuts and bolts with Teflon spray or another similar lubricant.

7.4 Spare parts

All spare parts must conform to the manufacturer's specifications.

7.5 Identifying spare parts

All spare parts are listed in the parts list. The parts list follows the installation requirements.

7.6 Special instructions for the disposal of individual equipment components

No special instructions are necessary for the disposal of individual equipment components.

7.7 Special measures during the break-in period

No later than 2 weeks after assembly, all screwed connections should be checked and tightened if necessary.

7.8 Drainage holes

All drainage holes should be kept clear.

7.9 Maintenance of protective surfaces

Surfaces providing fall protection must also be maintained regularly. It is particularly important to maintain the correct level of loose surface material and add more if necessary.

7.10 Faults



Faults must be repaired as soon as they are detected. If serious defects that compromise safety cannot be repaired straight away, the public must be prevented from using the equipment with immediate effect.

7.11 Loose screws



Loose screws always cause quality problems and put safety at risk. Therefore, loose screws should always be tightened and checks carried out to ensure that there are no missing screws (e.g. look out for holes you can see through).

7.12 Preventing equipment use

Use of the equipment should be prevented in the event of incomplete installation, disassembly, maintenance, repairs and faults.

7.13 Safeguarding the guarantee

Steel posts and footings are guaranteed if regular maintenance is carried out and recorded in writing. Maintenance first takes place after 3 years. The steel posts must be excavated as far as the concrete foundations and checked for corrosion. Zinc paint should be applied to any corroded areas and scratches.

It is recommended to carry out the inspection and maintenance work out in the specified time-frames, since wear and tear can occur through play, weathering influences or intentional damage, which compromises safety and function levels.

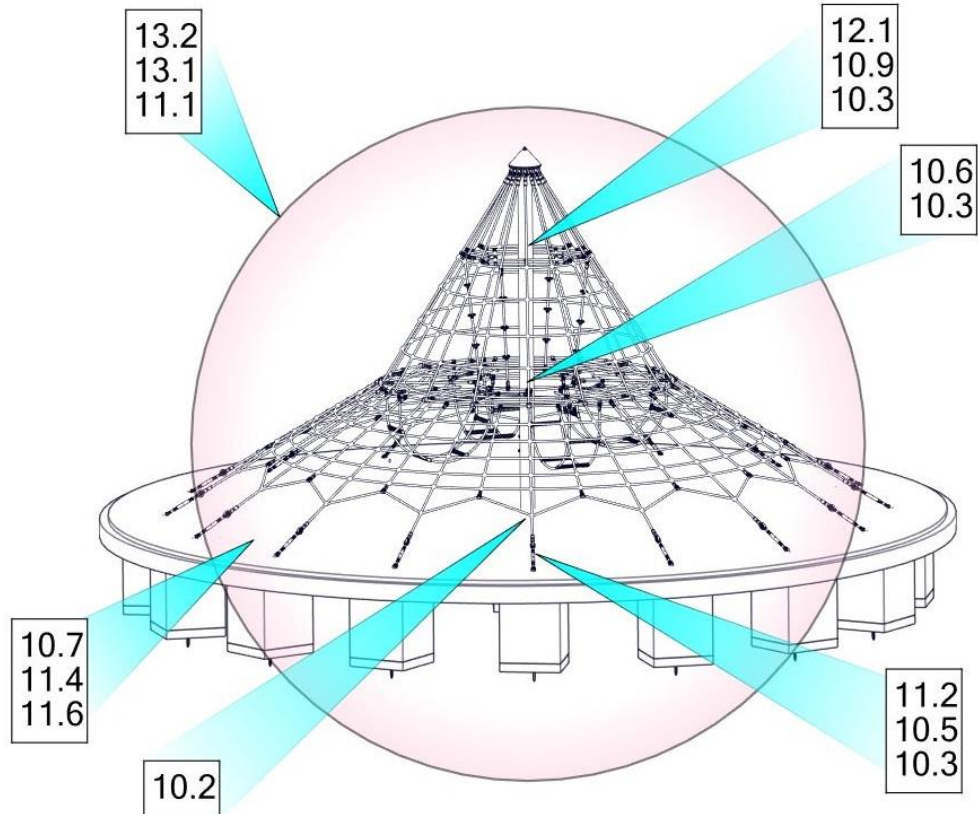
Defects, which compromise safety, must be treated promptly, either by immediately repairing or dismantling or closing down the equipment!

Defects, which compromise function, reduce the play value of the equipment and encourage vandalism, which may compromise safety levels. Damage should also be immediately repaired in this case.

Maintenance and servicing is to be carried only out by professionals.

General: Play equipment which is regularly checked may not be damaged in such a way that it becomes dangerous. However it is essential that where necessary repairs are followed up after regular checks.

8 Regular maintenance



9 Maintenance timetable

9.1 Special advices

9.1.1 Maintenance interval

We strongly advise you to carry out inspections and maintenance work within the specified periods as use of the equipment, the weather and malicious vandalism cause wear and tear that compromises the safety and function of the equipment.

9.1.2 Maintenance intervals in the event of intensive use

Please note that more frequent inspections and/or maintenance are required if the play equipment is subject to intensive use.

9.1.3 Faults that compromise safety



In the event of a fault that compromises safety, quick action must be taken. This may involve repairing it immediately or shutting down and dismantling the equipment.

9.1.4 Faults that compromise function



Faults that compromise function should also be repaired immediately. Such faults lower the value of the equipment to the user and encourage malicious vandalism, which may render the equipment less safe. Any damage should also be repaired immediately.

10 Monthly maintenance

- 10.1 Check the spaces between the equipment and the ground (clearance and height of fall).**
- 10.2 Check the ground surface in the area with fall protection for hard objects and loose foundations.**
- 10.3 Check all connecting elements and fittings for wear and tear and tighten if necessary. Replace damaged or missing parts.**
- 10.4 Check that moving metal parts (joints, springs, etc.) move smoothly and are not worn. Replace if necessary. It is not necessary to lubricate joints as we only use maintenance-free metal roller bearings.**
- 10.5 Check all attachments such as chains, ropes, nets, etc. for damage and replace if necessary.**
- 10.6 Check rubber parts, sleeves, etc. for wear and tear or damage and replace if necessary.**
- 10.7 If necessary, remove excess padding material from the post footings due to danger of rotting.**
- 10.8 Check the surface of wooden parts for damage caused by the weather or external influences and mould. Repair or replace if necessary.**
- 10.9 Check the surface of plastic and metal parts, e.g. slides, for damage and replace if necessary.**

11 Quarterly maintenance

- 11.1 Detailed inspection of the operation and stability of the equipment paying particular attention to any wear and tear.**
- 11.2 Tighten all forms of attachment.**
- 11.3 Repaint and retreat surfaces.**
- 11.4 Maintenance of fall protection surfaces.**
- 11.5 Lubrication of joints.**
- 11.6 Check the height of the fall and top up with loose filler if necessary. If the posts are labelled, top up as far as the mark.**
- 11.7 Retighten all bolts**

12 Half yearly maintenance

- 12.1 Stability (check posts, bracing, foundations, etc.). Ascertain whether there are any changes in equipment safety as a result of repairs that have been carried out or components that have been added or replaced.**



Annual Maintenance

13 Annual maintenance

- 13.1 **Ascertaining that the equipment, foundations and surfaces are safe for operation.**
- 13.2 **In particular, the equipment should be checked for decay and corrosion. It may be necessary to dig out or excavate certain components in order to do so. Zinc paint should be applied to corroded areas and scratches.**



The equipment must be inspected by someone **with the necessary expertise** in strict compliance with the instructions issued by Huck Seiltechnik GmbH.

A copy of the inspection record should be given to the operator, who must confirm receipt.

14 Maintenance printout

Name of item: Midi Cheops pyramid (registered design) / Art. No. 4643-2B _____

Location: _____

Customer or operator: _____
(Town, Town council, Kindergarten)

Date of inspection	Inspector	O.K.	Accessible	Barriered	Defects	Repaired by	Date

Please copy and return once a year after main inspection has been carried out to the manufacturer by Telefax (06443) 83 11 79!

15 Hand over document



After the installation of the equipment pass the installation and maintenance documents to the operator. The operator has to receive the hand over documents. The complete filled and signed hand over document should be sent to the supplier.

Art.-No.: 4643-2B

Type of item: Midi Cheops pyramid

Serial number:

Customer or operator (Town, Town council, Kindergarten, etc.):

Competent person in charge:

Installation company (address):

Responsible assistant (assembler):

Received the complete assembly instructions, maintenance instructions and maintenance printout.

(Signature of operator) (Signature of installation company)
(Stamp)

Date: _____

Please copy and return once a year after main inspection has been carried out to the manufacturer by Telefax (06443) 83 11 79!

Place the confirmation form in the play equipment files.