

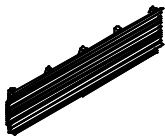









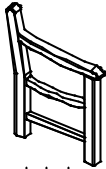







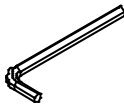

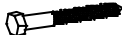
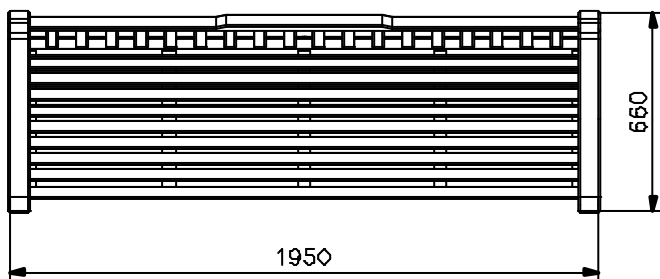
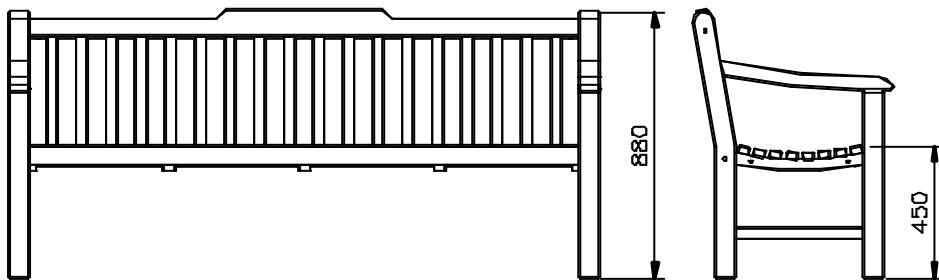
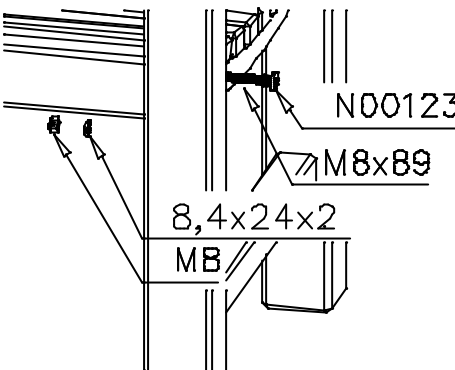
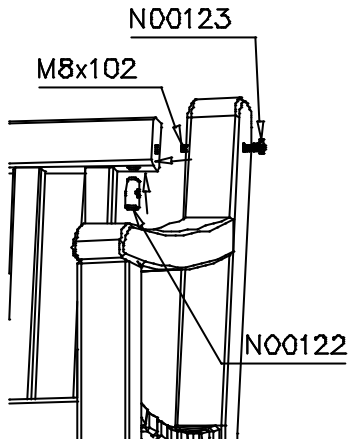
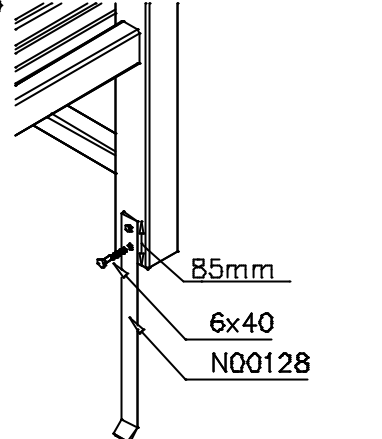
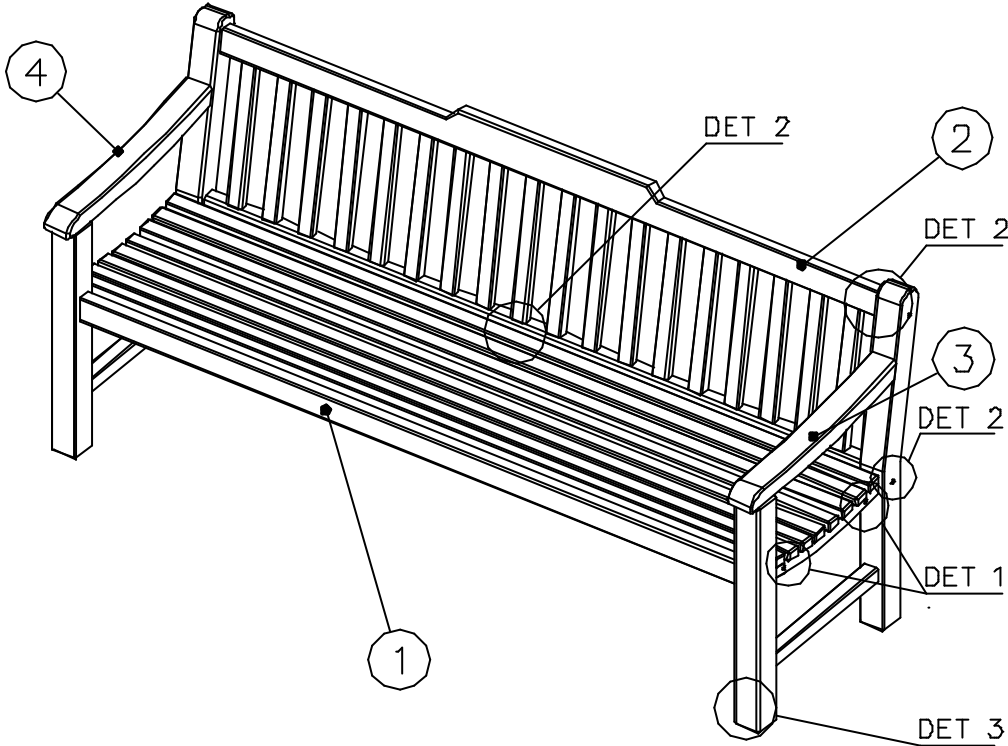
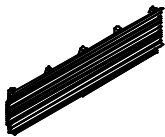

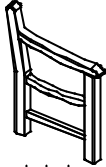
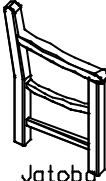
① Furu/Pine	ST	② Furu/Pine	ST
	1		1
Jatoba		Jatoba	
③ Furu/Pine	ST	④ Furu/Pine	ST
	1		1
Jatoba		Jatoba	
⑤ N00120	ST	⑥ N00121	ST
	5		4
M8x102		M8x89	
⑦ N00122	ST	⑧ N00123	ST
	5		9
M12x20		10x10 M8	
⑨ N01800	ST	⑩ N31024	ST
	4		4
M8		8,4x24x2	
⑪ N00107	ST	⑫ N00128	ST
	1		4
		L=400	
⑬ N60640	ST		ST
	8		
6x40			
	ST		ST



<p>DET 1</p>  <p>N00123 M8x89 8,4x24x2 MB</p>	<p>DET 2</p>  <p>N00123 M8x102 N00122</p>	<p>DET 3</p>  <p>85mm 6x40 N00128</p>

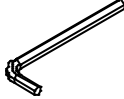

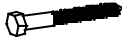
① Furu/Pine	ST	② Furu/Pine	ST
	1		1
Jatoba		Jatoba	
③ Furu/Pine	ST	④ Furu/Pine	ST
	1		1
Jatoba		Jatoba	
⑤ N00120	ST	⑥ N00121	ST
	5		4
M8x102		M8x89	
⑦ N00122	ST	⑧ N00123	ST
	5		9
M12x20		10x10 M8	
⑨ N01800	ST	⑩ N31024	ST
	4		4
M8		8,4x24x2	
⑪ N00107	ST	⑫ N00128	ST
	1		4
		L=400	
⑬ N60640	ST		ST
	8		
6x40			
	ST		ST

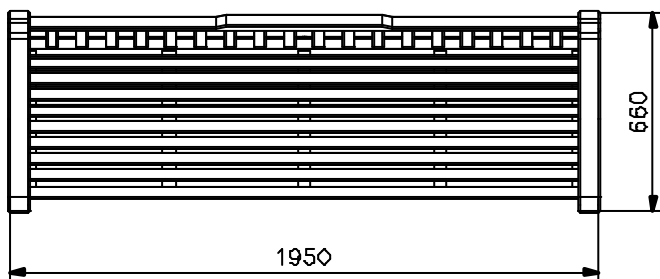
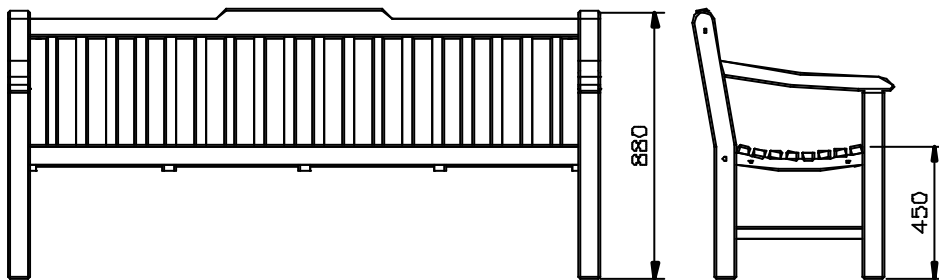

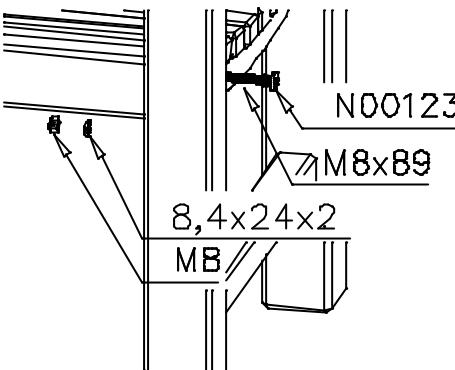
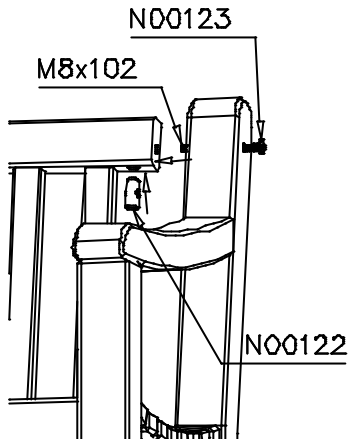
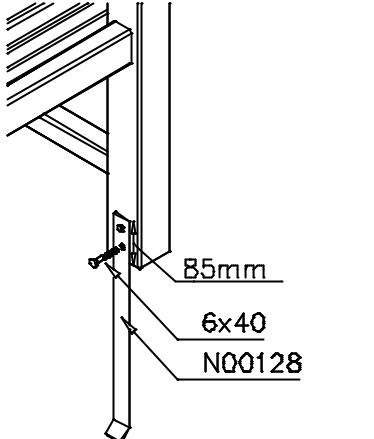
<p>DET 1</p>  <p>N00123 M8x89 8,4x24x2 MB</p>	<p>DET 2</p>  <p>N00123 M8x102 N00122</p>	<p>DET 3</p>  <p>85mm 6x40 N00128</p>