

Use and movement areas

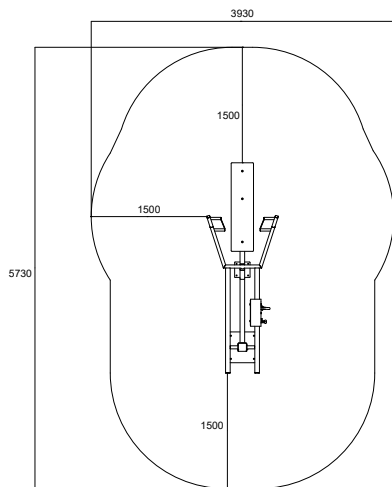

Target muscles

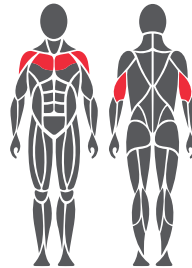

Foundation

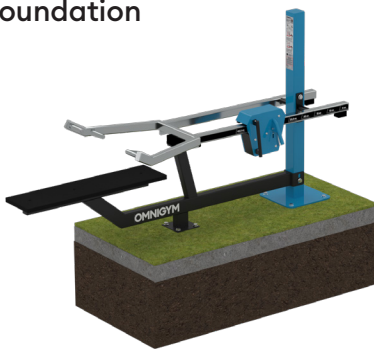

1. For example artificial turf or moldable safety platform max. 24 mm
2. Concrete min. 120 mm below equipments
3. Ground frost insulation, thickness based on the ground

Concrete casting and positioning

- Length 2500 mm
Width 1000 mm
Thickness 120-150 mm
- Ground frost insulation
 - Rebaring
 - Adequate drying time must be ensured

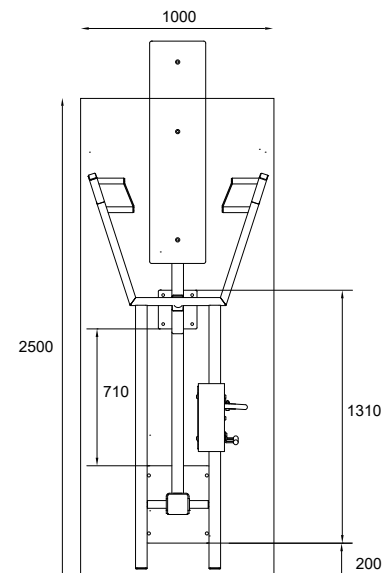

Product specification

Length	2730 mm
Width	930 mm
Height	1430 mm
Equipment weight	164,2 kg(1 x weight unit) 223,4 kg (2 x weight unit)
User height	+ 140 cm
Age	+ 14
Safety area	18,1 m ²
Base	surface mounting to concrete
Standard	EN16630
Country of manufacture	Finland
Metal parts	Steel
Movement arm	Stainless steel
Tube strengths	3-6 mm
Coating solution	Zink and powder coating, electropolishing

Details

- Effective and safe exercise equipment
- Adjustable loading
- Multigrip (height)
- Maintenance-free and protected stainless steel ball bearing
- 15-55 kg (1 x weight unit)
- 10-85 kg (2 x weight units)
- The product comes as standard in RAL Classic colours RAL 5012 (blue), RAL 1017 (yellow), RAL 3020 (red), RAL 6018 (green) or RAL 7024 (grey). Other RAL colors are available at an additional cost.
- Can be installed on a movable platform

Important

Installation depth for all Omnigym units: top surface of the concrete base on the ground level or max. -20 mm allowance for the surface material to be used. (See foundation figure)