

N**Monteringsanvisning****EN****Assembly Instructions****S****Monteringsanvisning**

Produkt nr. / Product no. / Produkt nr.

07-520-834K

Grå

Ord. nr. _____

Dato. _____

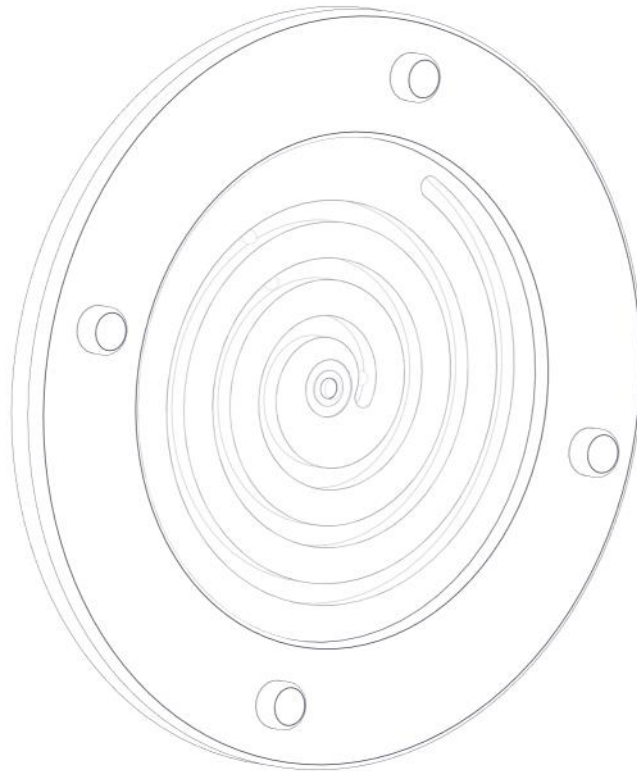

Sign. _____

**søve**

Søve AS
Grønnvoldveien 290
3830 Ulefoss - Norway
Tlf: +47 35 94 65 65
www.sove.no

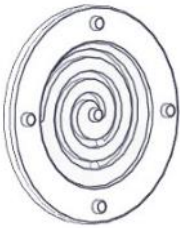
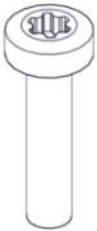
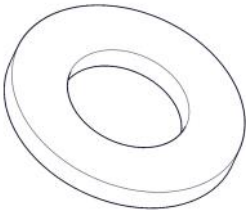
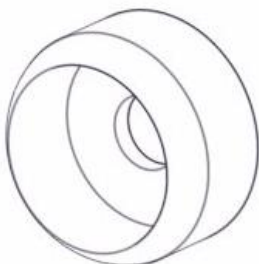

Søve AB
EA Rosengrensgatan 32
421 31 Västra Frölunda
Phone: +46 (0)31 773 97 00
www.sove.se

Boltepakker for / Boltpackage for / Bultpaket för		Sign. _____		
Hjull komplett 07-520-834K	Navn	Artnr/dimensjon	Ant	Lev
	Hjul buss	07-520-834	1	
	Torx M8x20 Torx M8x25	04-000-020 04-000-025	1 1	
	Skive M8 M10 Polyfix Avstandskive POM 40x3,5	04-050-008 04-055-036 02-500-017	1 1 2	
	Ene deksel M10 sort Kropp	05-301-035	1	
	Ene deksel M10 sort hode	05-301-035	1	
	Hylsegjenge M8 L=30	04-021-007	1	

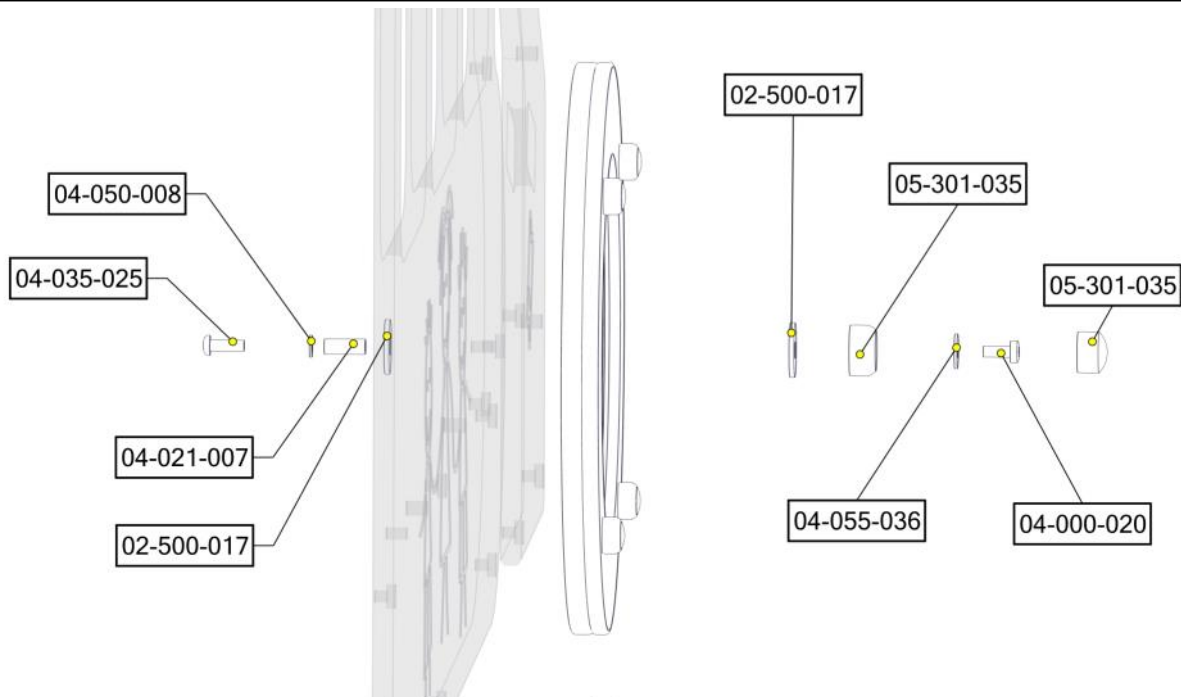

Montering av lekeapparatet / Assembly instructions / Montering av lekredskapet

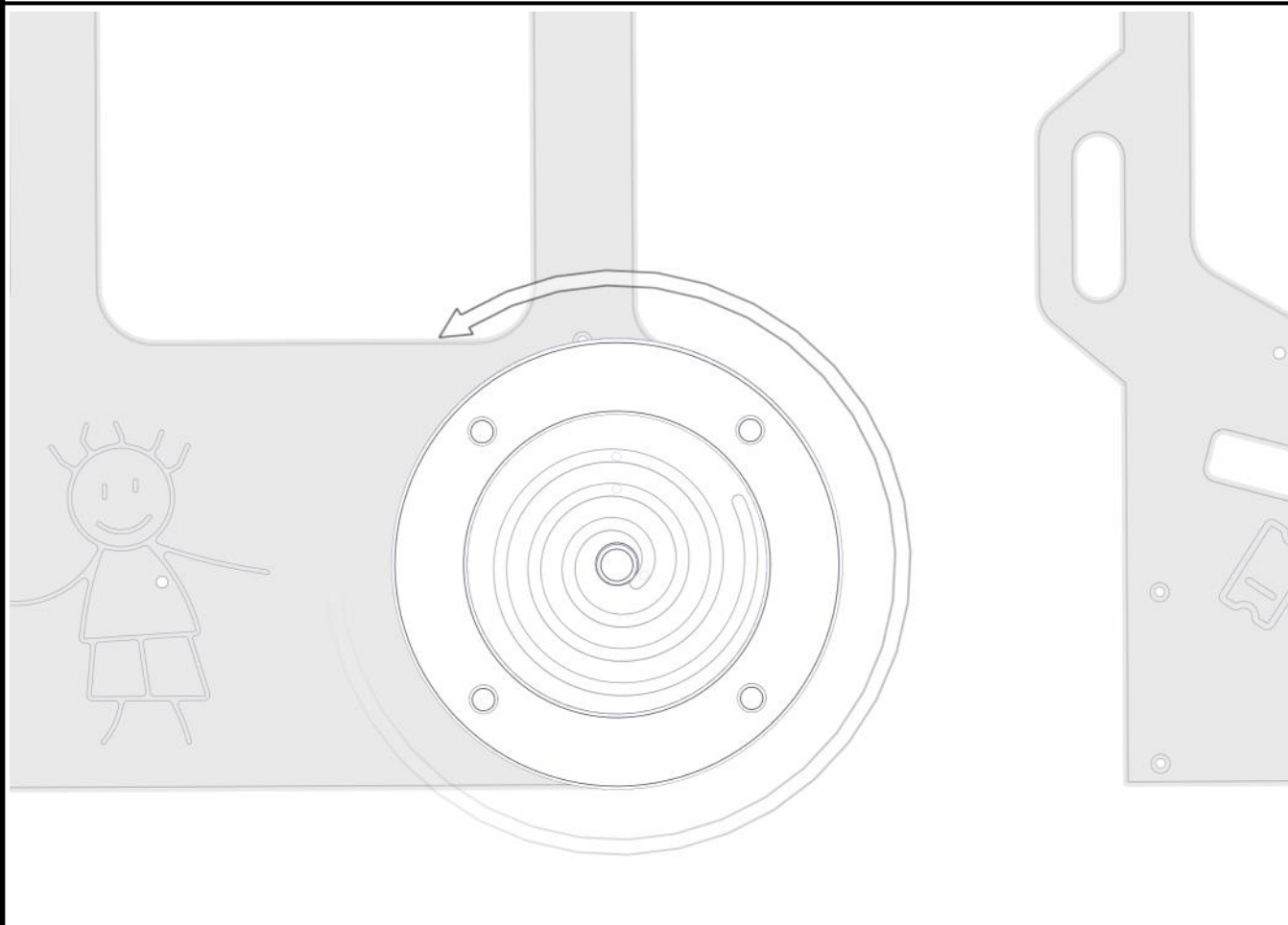

PartName	Artnr	Antall
Avstandskive_POM40x3,5 for M10	02-500-017	2
Torx M8x20	04-000-020	1
Hylsegjenge M8 L=30	04-021-007	1
Unbrako M8x25	04-035-025	1
Skive M8	04-050-008	1

PartName	Artnr	Antall
Skive M10 Polyfix	04-055-036	1
Endedeksel flatt M10/M12 sort	05-301-035	2
Hjul_Buss	07-520-834	1

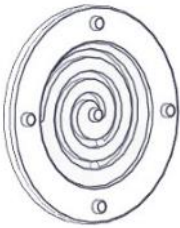
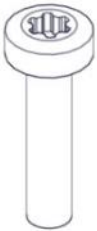
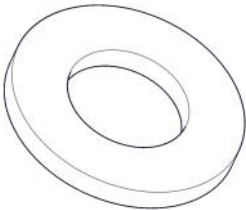
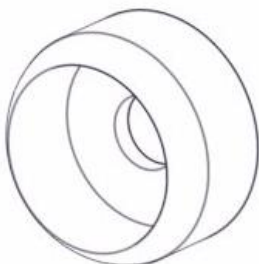

Boltepakker for / Boltpackage for / Bultpaket för		Sign. _____		
Hjull komplett 07-520-834K	Navn	Artnr/dimensjon	Ant	Lev
	Hjul buss	07-520-834	1	
	Torx M8x20 Torx M8x25	04-000-020 04-000-025	1 1	
	Skive M8 M10 Polyfix Avstandskive POM 40x3,5	04-050-008 04-055-036 02-500-017	1 1 2	
	Ene deksel M10 sort Kropp	05-301-035	1	
	Ene deksel M10 sort hode	05-301-035	1	
	Hylsegjenge M8 L=30	04-021-007	1	