

N**Monteringsanvisning****EN****Assembly Instructions****S****Monteringsanvisning**

Produkt nr. / Product no. / Produkt nr.

26-100-030

Ord.. nr. _____

Dato. _____

Sign. _____

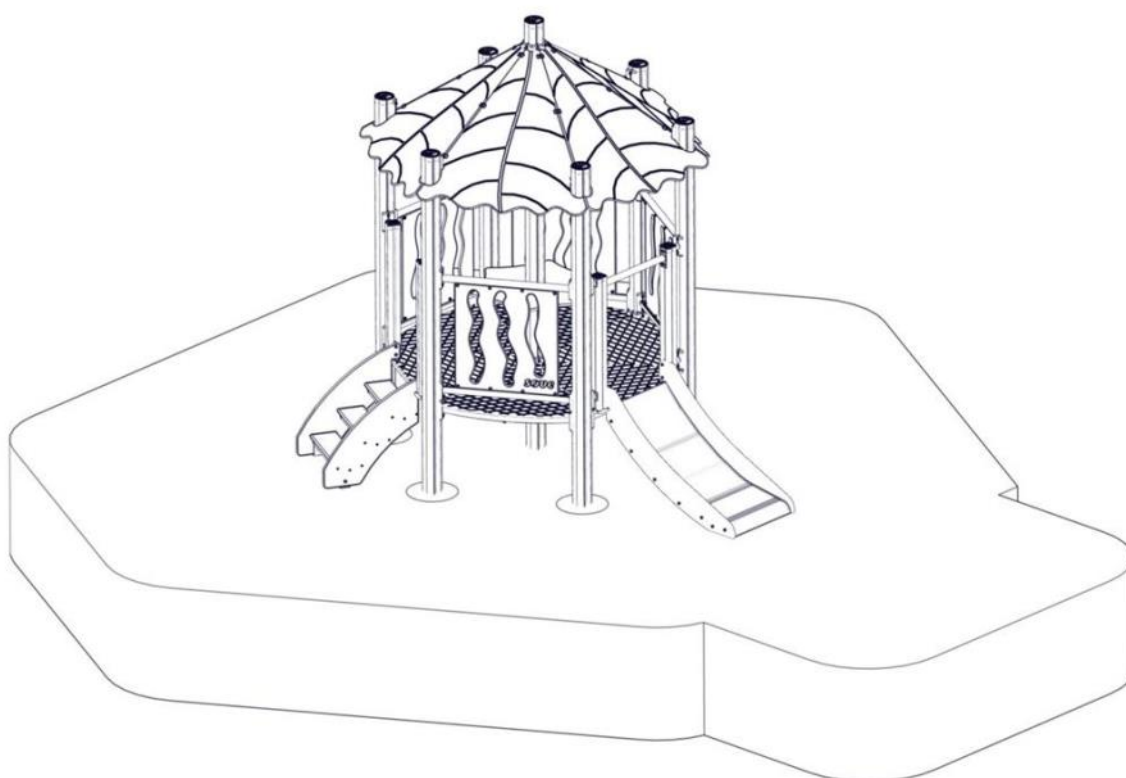
**søve**

Søve AS
Grønnvoldveien 290
3830 Ulefoss - Norway
Tlf: +47 35 94 65 65

**søve**

Søve AB
EA Rosengrensgatan 32
421 31 Västra Frölunda
Phone: +46 (0)31 773 97 00
www.sove.se

Monteringstips / Assembly Advice / Monteringsstips

N

- Les monteringsanvisningen nøye før montering.
- Monter elementene i rekkefølgen som vist.
- Boltene bør ikke skrues for hardt til før alt er montert, vatret og loddet. Skru så boltene til.
- NB! Ved bruk av drill, kan boltene ryke.
- Er lekeutstyret plassert i naturlige ferdselstraséer må området sikres mot gjennomgang.
- Innspringningshinder bør vurderes rundt lekeapparater hvor det er stor bevegelse, f.eks. ved huskestativ.
- Det bør være fritt innsyn til lekeutstyr som er beregnet for barn under 3 år.

NB! Under monteringsarbeidet må utstyr, som ikke er forankret forsvarlig i bakken, sikres slik at det ikke velte.

Området må avstenges under montering av apparatene med sperrebånd eller lignende.

EN

- Read the instruction carefully before assembling the play unit..
- Assemble the components in the sequence shown in these instructions.
- Fixings must not be fully tightened during assembly. Before casting the foundations, the structure must be level and plumb, at which point all fixings are tightened.
- PS! If use of drill, the bolts may be wrecked.
- Secure the construction-area to prevent people from walking through it.
- Consider installing barriers around play-equipment which gives rise to a lot of activity – i.e.swings.
- Ensure that clear vision is possible across the play area so that supervision is possible from any position, particularly where children under 3 years of age will be playing.

NB! During assembly of the equipment, ensure that all structures are securely propped, especially when left overnight. Also ensure that equipment is supported whilst concrete foundations are setting and enclose the area securely to prevent access.

Monteringstips / Assembly Advice / Monteringsstips**S**

- Läs monteringsanvisningen noga före montering.
- Montera delarna i den ordningen som anvisas
- Skruvarna bör inte skruvas för hårt tills allt är monterat, i våg och lodat.









OBS! Används elektrisk skruvdragare, kan bulten gå sönder. Hårddra därför manuellt!

- Om lekplatsen placeras vid en gångväg mm bör området säkras mot genomfart av gående och cyklister.
- Inspringningshinder bör placeras runt lekutrustning med stor rörelse, t ex, gungställning.
- Det bör vara fri insyn till lekutrustning beräknat till barn under 3 år.

OBS! Under monteringsarbete bör utrustningen som inte ska förankras i marken, ställs så att den inte kan välta.

Området måste spärras när lekutrustningen byggs upp, med avspärrningsband eller liknande.

Nødvendig verktøy / Tools required / Nödvändiga verktyg

<p>(N)</p> <p>(EN)</p> <p>(S)</p>	<p>(A)</p> 	<p>(B)</p>  <p>Torx Nr 45 High quality</p>	<p>(C)</p>	<p>(D)</p> 	<p>(E)</p> 
		<p>Metermål</p> <p>Metric measure</p> <p>Tumstock</p> 	<p>16 V</p> 	<p>Merkebånd</p> <p>Mark ribbon</p> <p>Märkeband</p> 	

Nødvendig antall personer / Number of persons required / Rekommenderad antal personer

<p>(N)</p> <p>(EN)</p> <p>(S)</p>	
-----------------------------------	---

Anbefalt arealbehov ved montering / Recommended working space / Rekommenderad arealbehov vid montering

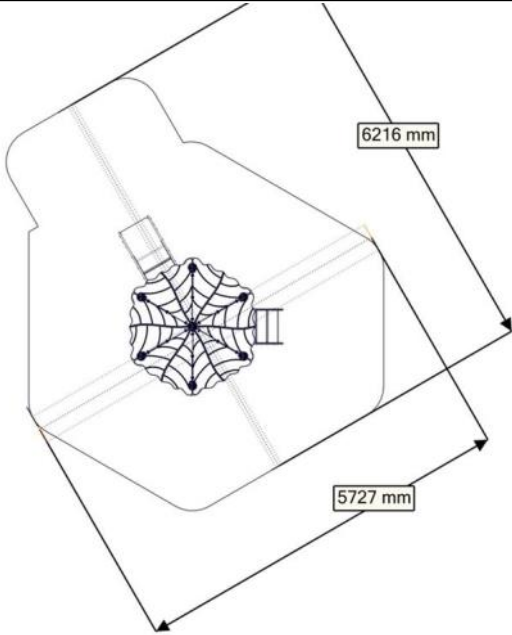
<p>(N)</p> <p>(EN)</p> <p>(S)</p>	
-----------------------------------	--

Fallhøyder / Free height of fall / Fallhöjder

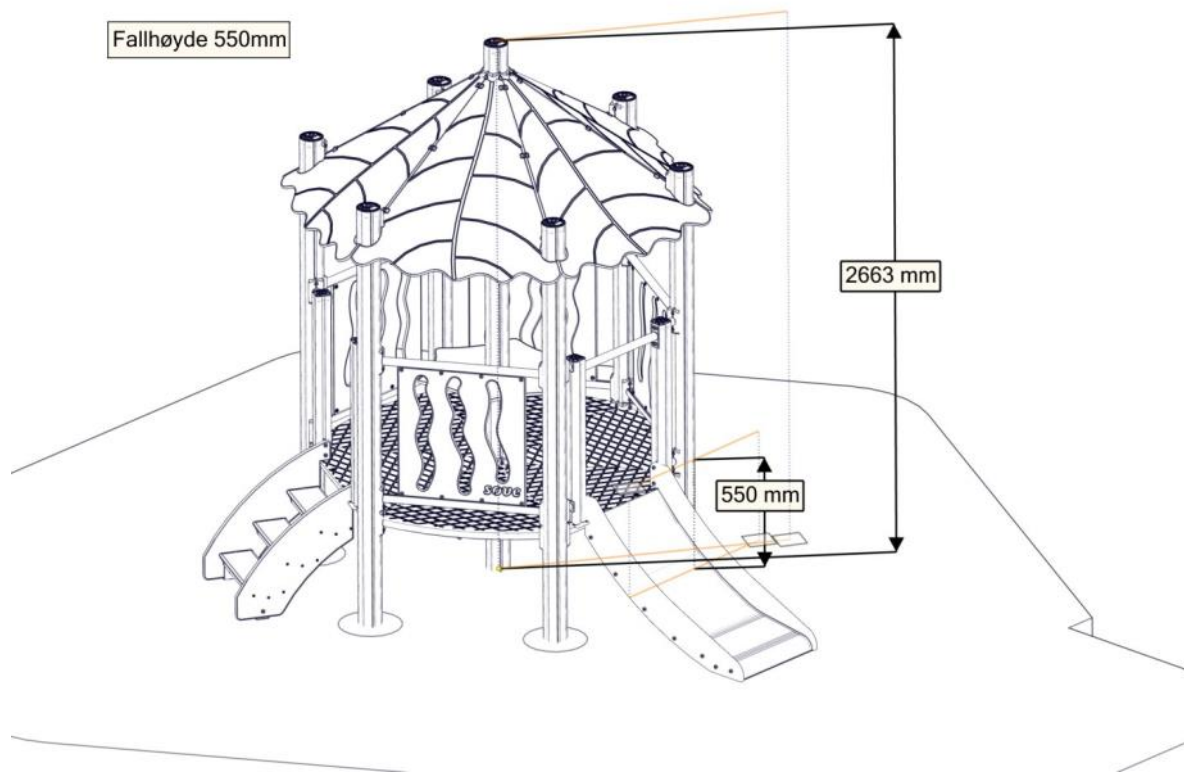

Sikkerhetszone / Safety zone / Säkerhetszon

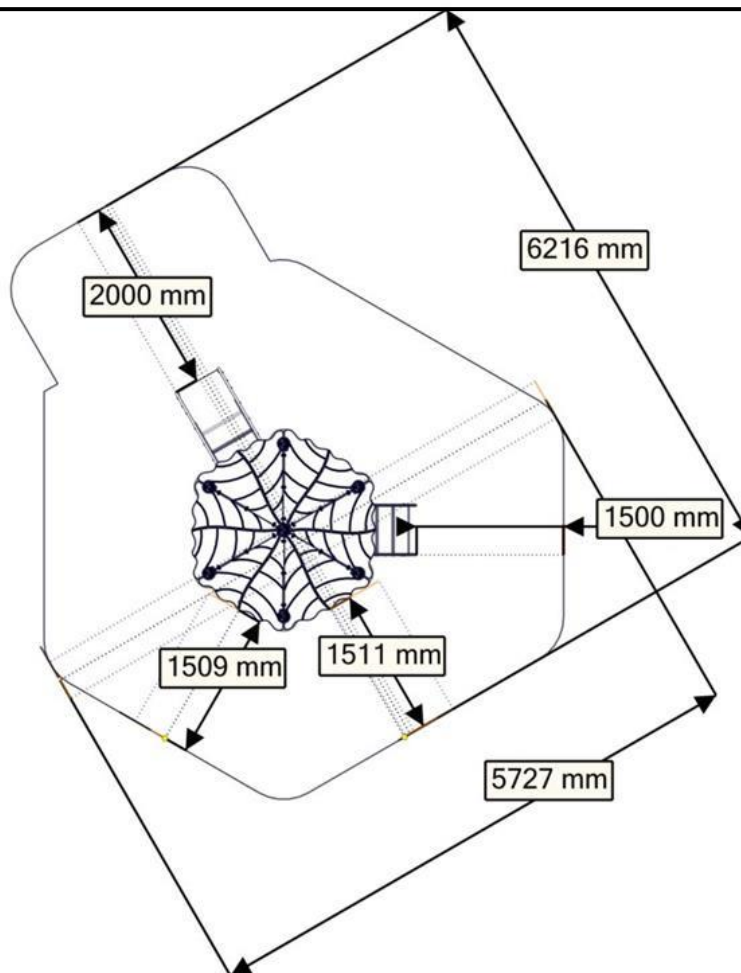

Plassering av forankringer / Ground plan / Placering av förankringar

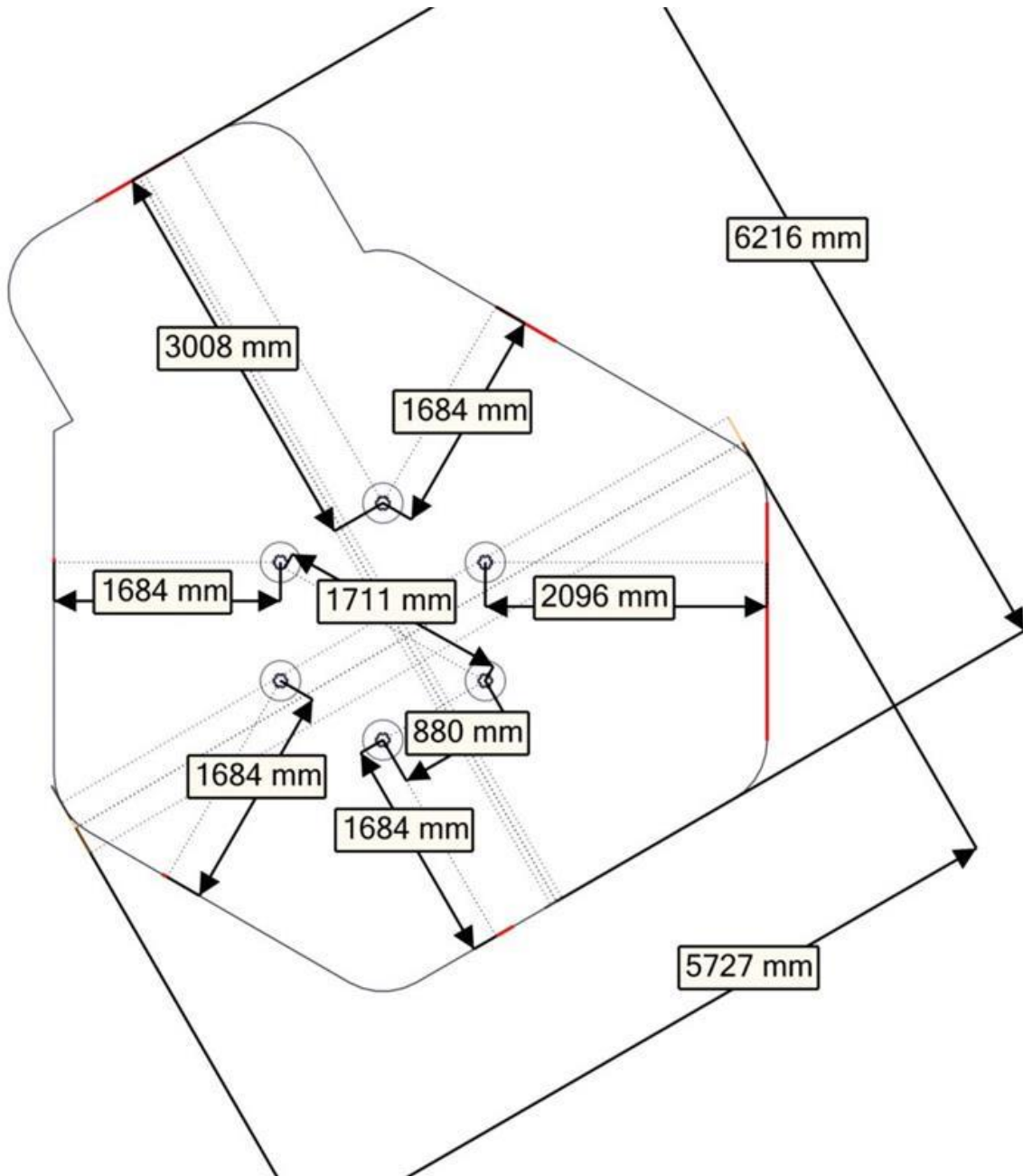

N

Alle mål er oppgitt i millimeter

EN

Scale measured in mm

S





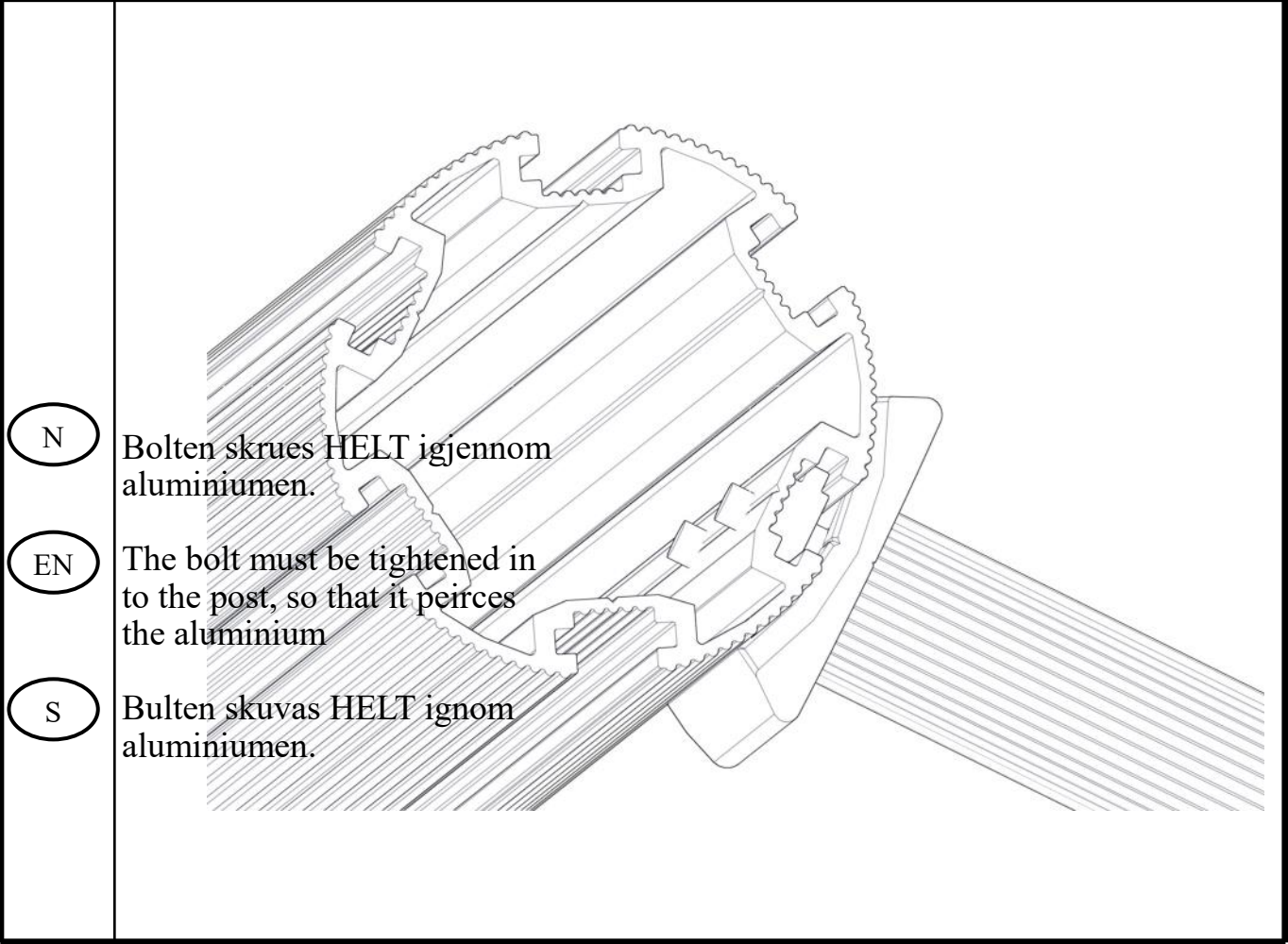
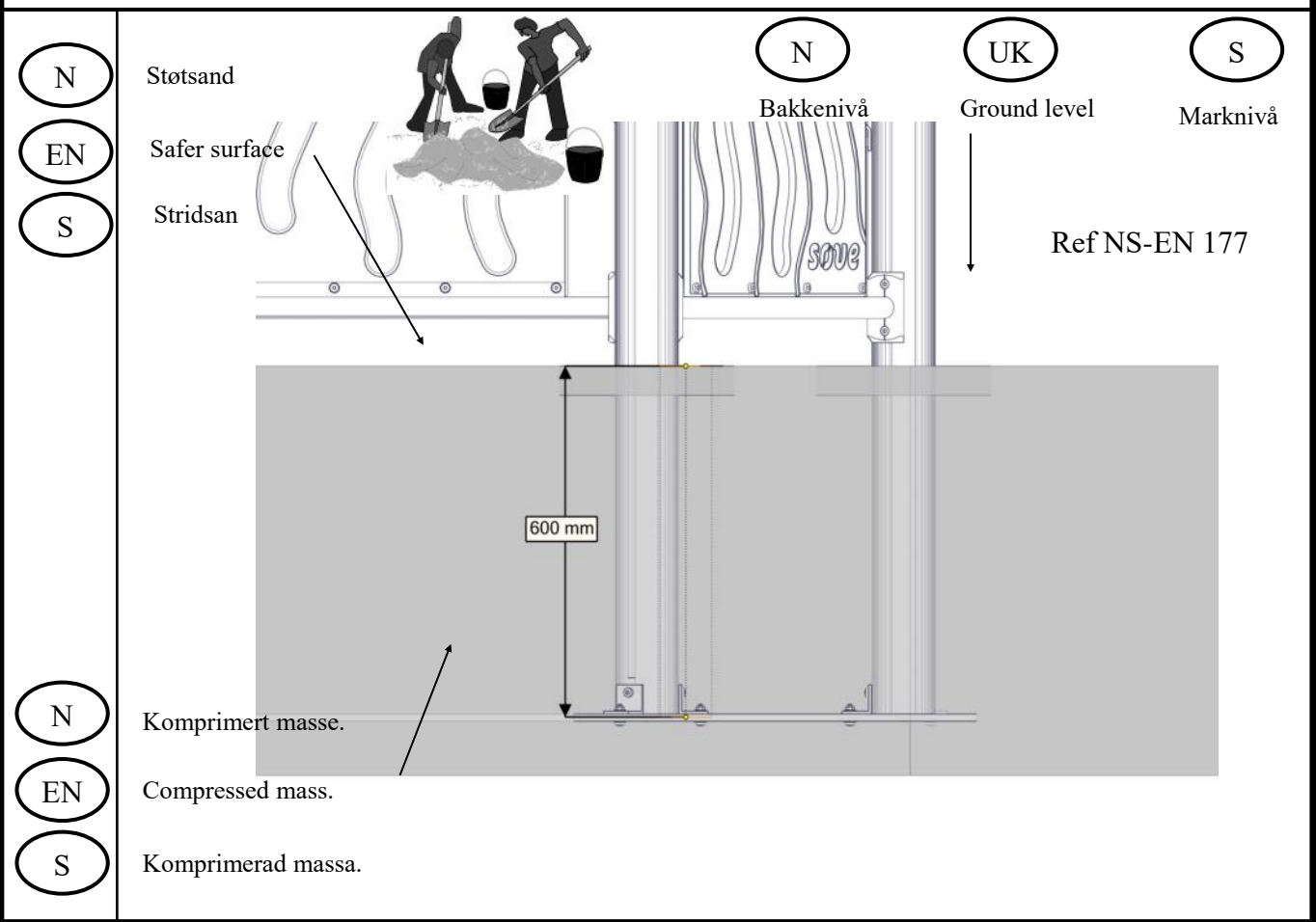







Alla mått är i millimeter.

Fundamentering uten betong / Foundation without concrete

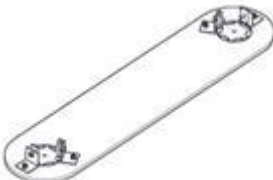
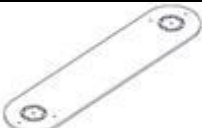











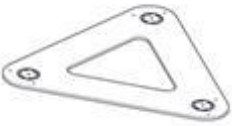

Boltepakker for / Boltpackage for / Bultpaket för

Sign. _____

Stolpe 110	Ant= 4	Navn	Artnr/dimensjon	Ant	Lev
		Stolpe 110 L=2700 600-2100 (6) Stolpe 110 L=3250 600-2650(1)	07-100-334 07-100-334	6 1	
Stolpende	Ant= 7	Navn	Artnr/dimensjon	Ant	Lev
		Endelokk (1)	00-400-995	7	
Produktmerke	Ant= 1	Navn	Artnr/dimensjon	Ant	Lev
		Ogr 150_2H (1) Med Produktmerke	07-500-500	1	
		Brikke 150_2T(1)	04-060-151	1	
		Torx M8x35 (2)	04-000-035	2	
Fundament 07-400-102 2stolpe	Ant= 2	Navn	Artnr/dimensjon	Ant	Lev
		Dobbel fun plate (1)	07-400-002	2	
		Vinkel 50x50x50(4)	04-070-050	8	
		Brikke 50_1T(4)	04-060-050	8	
		Torx M8x30 (4) Torx M8x25(4)	04-000-030 04-000-025	8 8	
		Skive M8 (8)	04-055-008	16	
		Låsemutter M8 (4)	04-040-008	8	







Boltepakker for / Boltpackage for / Bultpaket för

Sign. _____

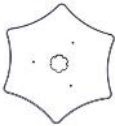
Fundament 07-400-103 3stolpe	Ant= 1	Navn	Artnr/dimensjon	Ant	Lev
		3Kant fun plate (1)	07-400-003	1	
		Vinkel 50x50x50(6)	04-070-050	6	
		Brikke 50_1T(6)	04-060-050	6	
		Torx M8x30 (6) Torx M8x25(6)	04-000-030 04-000-025	6 6	
		Skive M8 (12)	04-055-008	12	
		Låsemutter M8(6)	04-040-008	6	
Rekkverk cc880 07-302-130 åpen	Ant= 4	Navne	Artnr/dimensjon	Ant	Lev
		Sperrerør med lepp (2)	07-302-110	8	
		Vegg 655x610 cc880 (1) Åpen	07-302-130	4	
		Torx M8x12 (8) Torx M8x25 (8)	04-000-012 04-000-025	32 32	
		Møbelknapp 16x11 (8)	04-030-011	32	
		Brikke 120_3T(4)	04-060-120	16	









Boltepakker for / Boltpackage for / Bultpaket för









Sign. _____.

Bord 07-520-620	Ant= 1	Navne	Artnr/dimensjon	Ant	Lev
		Butikkdisk cc880 (1)	07-520-605	1	
		Feste 45gr (3) 120x120x40x5	04-400-001	3	
		Torx M8x12 (3) Torx M8x20 (3)	04-000-012 04-000-020	3 3	
		Møbelknapp 16x11 (3)	04-030-011	3	
		Brikke 50_1T(3)	04-060-050	3	
		Skive M8 (3)	04-050-008	3	

Boltepakker for / Boltpackage for / Bultpaket för

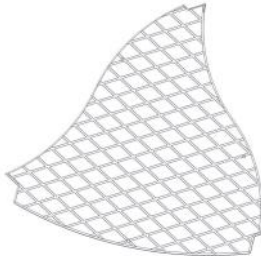







Sign. _____

6kant tak 07-500-600	Ant= 6	Navn	Artnr/dimensjon	Ant	Lev
		6kant tak (1)	07-500-600	6	
		Sperrerør 6kant tak	07-150-064	6	
		Fest U 6-kant tak	07-520-611	18	
		Møbelknapp (3) 16x11	04-030-011	18	
		Torx M8x45 (3)	04-000-045	18	
		Sekskant M8x35 Rustfritt	04-058-008	24	
		Skive rustfritt M8	04-058-008	24	
		Brikke 150 2xM8	04-060-151	12	

Boltepakker for / Boltpackage for / Bultpaket för					Sign. _____.	
Gulv 07-301-133 6kant rutsjebane brun	Ant= 2	Navne	Artnr/dimensjon	Ant	Lev	
		gulv (1)	07-300-133	2		
		Møbelknapp (3)	04-030-011 M8_13_17	6		
		Torx M8x45 (3)	04-000-045	6		
		Plug 9mm (6)	04-090-002	12		
Gulv 07-301-120 6kant std brun	Ant= 4	Navn	Artnr/dimensjon	Ant	Lev	
		gulv (1)	07-301-120	4		
		Møbelknapp (3)	04-030-011 M8_13_17	12		
		Torx M8x45 (3)	04-000-045	12		
		Plast plug 9-11mm (2)	04-090-002	8		













Boltepakker for / Boltpackage for / Bultpaket för

Sign. _____.

Sperrerør_ : 07-500-064	Ant= 8	Navn	Artnr/dimensjon	Ant	Lev
		Sperrerør_(1) 2 hull 6kant gulv	07-150-064	8	
		Brikke 120_2T (2) På stolpe	04-060-120	0	
		Torx M8x25 (4)	04-000-025	32	
Sperrerør_ : 07-500-061 Med hull gulv	Ant= 4	Navn	Artnr/dimensjon	Ant	Lev
		Sperrerør_gulv (1)	07-150-061	4	
		Brikke 120_2T (2) på stolpe	04-060-120	0	
		Torx M8x25 (4)	04-000-025	16	









Boltepakker for / Boltpackage for / Bultpaket för

Sign. _____

Portal_ : 01-400-230	Ant= 1	Navn	Artnr/dimensjon	Ant	Lev
		Feste portal (4)	01-400-231	4	
		Endelokk 70x70 (2)	00-400-996	2	
		Stolpe 70x70 (2) L=820	SFA5123_820	2	
		Sperrerør (1) L=520	07-510-160	1	
		Brikke 120_2T (6) Brikke 50_1T(4)	04-060-120 04-060-050	6 4	
		Torx M8x25 (16)	04-000-025	16	
Portal_ : 01-400-233	Ant= 1	Navn	Artnr/dimensjon	Ant	Lev
		Feste portal (4)	01-400-231	4	
		Endelokk 70x70(2)	00-400-996	2	
		Stolpe 70x70 (2) L=820	SFA5123_820	2	
		Brikke 120_2T (4) Brikke 50_1T(4)	04-060-120 04-060-050	4 4	
		Torx M8x25 (12)	04-000-025	12	









Boltepakker for / Boltpackage for / Bultpaket för

Sign. _____

Rutsjebane 550 07-510-305	Ant= 1	Navn	Artnr/dimensjon	Ant	Lev
		Rutsjebane	07-510-305	1	
		Brikke120 3T(2)	04-060-120	2	
		Torx M8x35(4) Torx M8x45(2)	04-000-035 04-000-045 04-000-	8 2	
		Fundamentskive(2) 2H 80	00-003-106	2	
		Skive M8(2)	04-050-008	4	
		Mutter M8(2)	04-040-008	6	
		Stålforankering(2)	00-100-312	2	

Boltepakker for / Boltpackage for / Bultpaket för

Sign. _____.

Trappe 550 01-290-090	Ant= 1	Navn	Artnr/dimensjon	Ant	Lev
		Rutsjebane	01-290-090	1	
		Brikke90 3T(5)	04-060-090	2	
		Torx M8x35(4)	04-000-035	10	
		Fundamentskive(2) 2H 80	00-003-106	2	
		Skive M8(2)	04-050-008	6	
		Mutter M8(2)	04-040-008	6	
		Stålforankering(2)	00-100-312	2	

Montering av lekeapparatet / Assembly instructions / Montering av lekredskapet

Brikke påmentert hos Søve

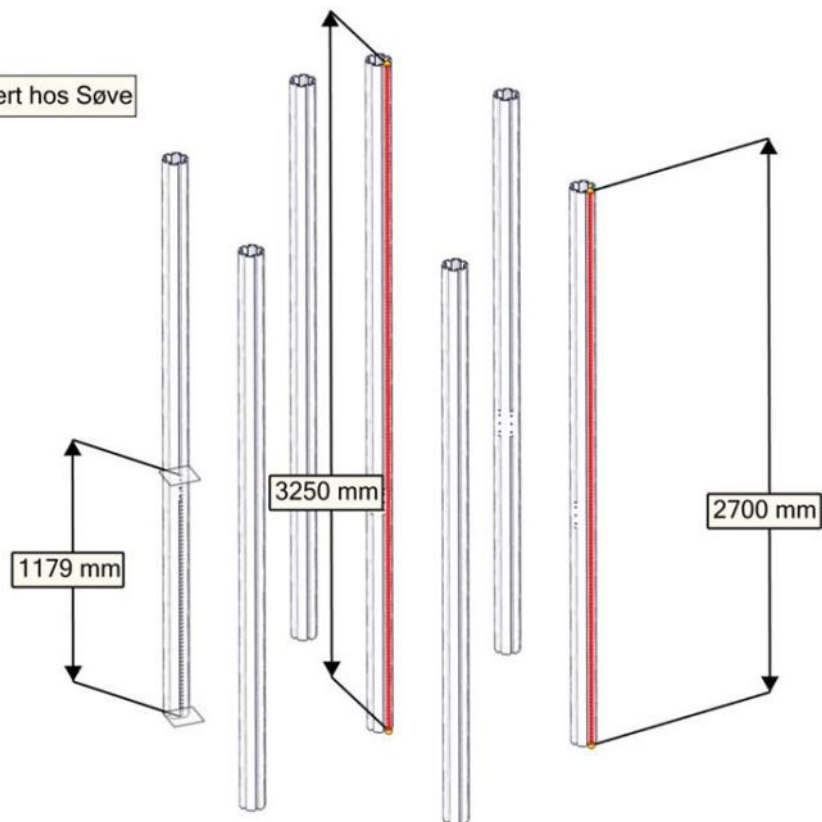

Brikke påmontert hos Søve

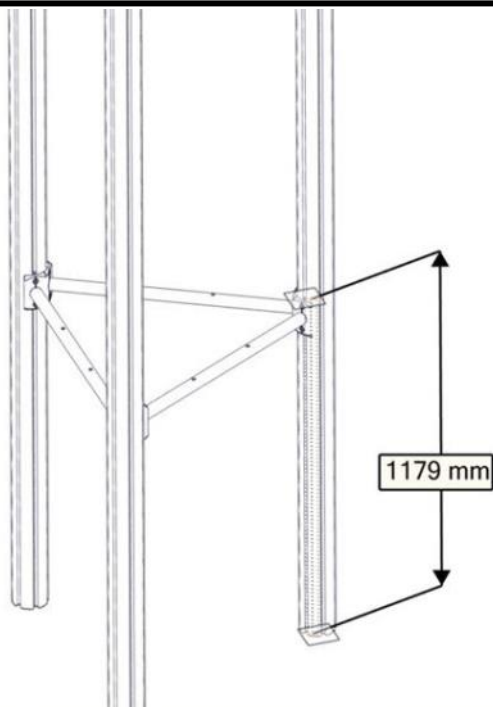

nr	PartName	Artnr	Antall
1	Stolpe 110 600-2	07-100-334	3
2	Sperrerør 6kant gulv 2 hull	07-500-064	3
3	Torx M8x25	04-000-025	6
4	Torx M8x25	04-000-025	6

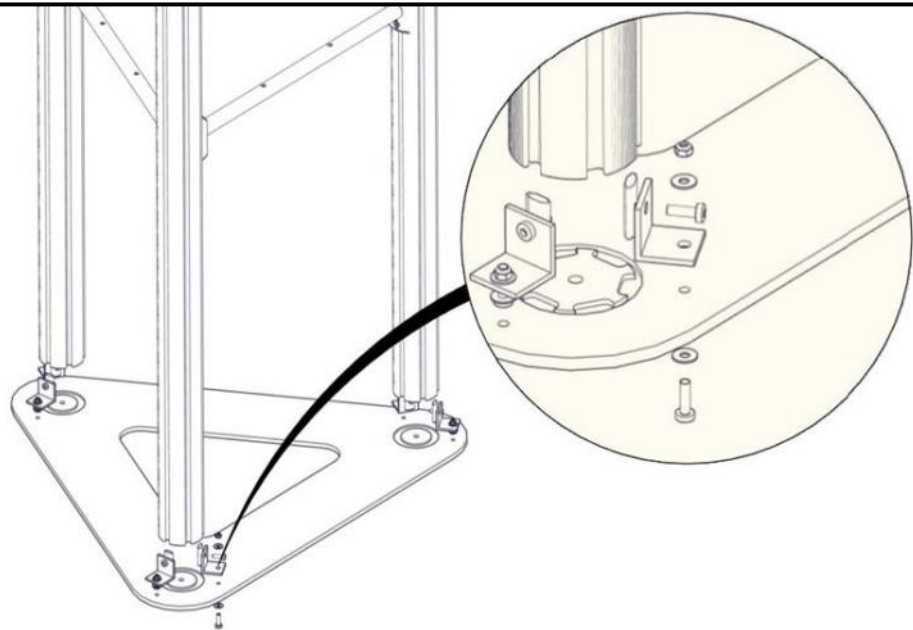

nr	PartName	Artnr	Antall
1	Vinkel 50x50x50x5 11mm hull	04-070-050	6
2	Brikke50 1XM8	04-060-050	6
3	Fundamentplate 3 stolper	07-400-013	1
4	Låsemutter M8	04-040-008	6
5	Skive M8 stor	04-055-008	6

nr	PartName	Artnr	Antall
6	Skive M8 stor	04-055-008	6
7	Torx M8x25	04-000-025	6
8	Torx M8x30	04-000-030	6

Brikke påmontert hos Søve

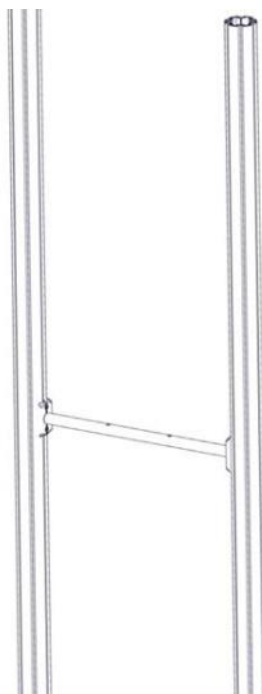

nr	PartName	Artnr	Antall
1	Stolpe 110 600-2100 L=2700	07-100-334	2
2	Sperrerør 6kant gulv 2 hull	07-500-064	1
3	Torx M8x25	04-000-025	2
4	Torx M8x25	04-000-025	2

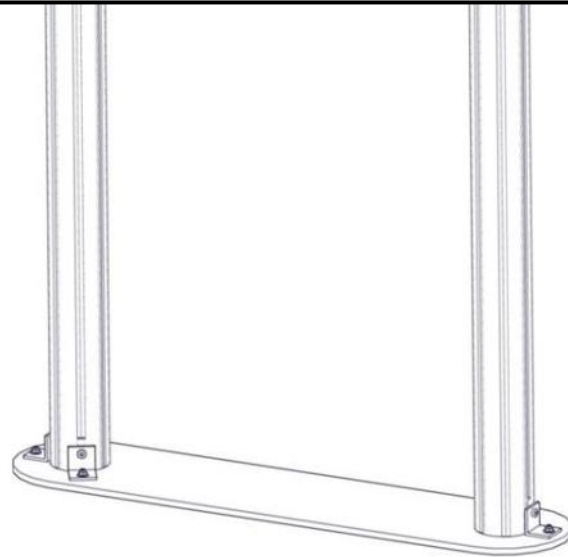

nr	PartName	Artnr	Antall
1	Vinkel 50x50x50x5 11mm hull	04-070-050	4
2	Brikke50 1XM8	04-060-050	4
3	Fundamentplate 2 stolper	07-400-012	1
4	Låsemutter M8	04-040-008	4
5	Skive M8 stor	04-055-008	4

nr	PartName	Artnr	Antall
6	Skive M8 stor	04-055-008	4
7	Torx M8x25	04-000-025	4
8	Torx M8x30	04-000-030	4

Brikke påmontert hos Søve

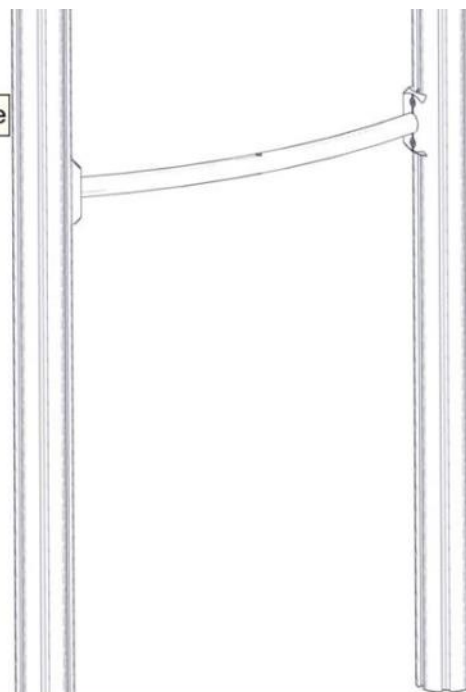

nr	PartName	Artnr	Antall
2	Stolpe 110 600-2100 L=2700	07-100-334	2
1	Sperrerør hull gulv	07-150-061	1
3	Torx M8x25	04-000-025	2
4	Torx M8x25	04-000-025	2

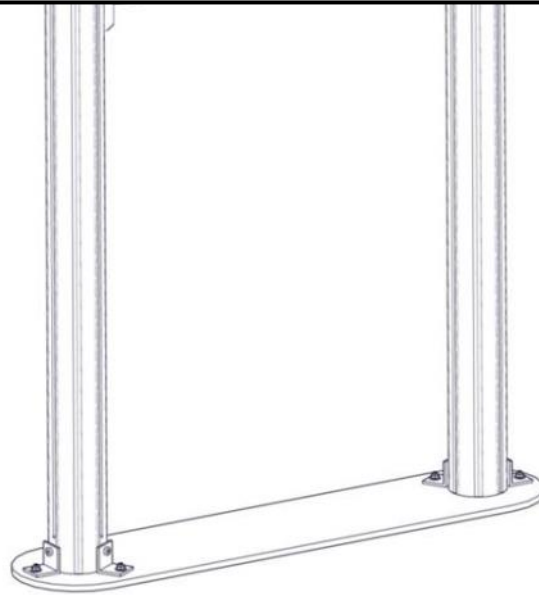

nr	PartName	Artnr	Antall
1	Vinkel 50x50x50x5 11mm hull	04-070-050	4
2	Brikke50 1XM8	04-060-050	4
3	Fundamentplate 2 stolper	07-400-012	1
4	Låsemutter M8	04-040-008	4
5	Skive M8 stor	04-055-008	4

nr	PartName	Artnr	Antall
6	Skive M8 stor	04-055-008	4
7	Torx M8x25	04-000-025	4
8	Torx M8x30	04-000-030	4

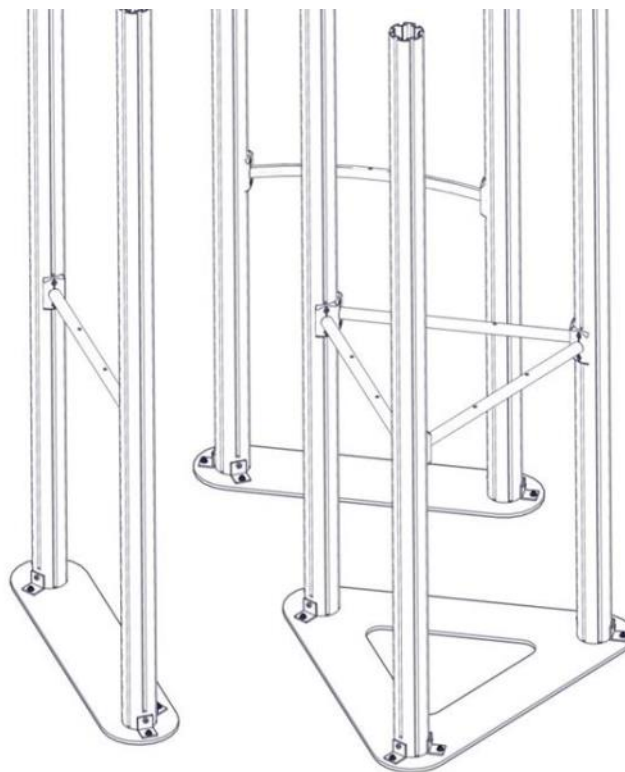

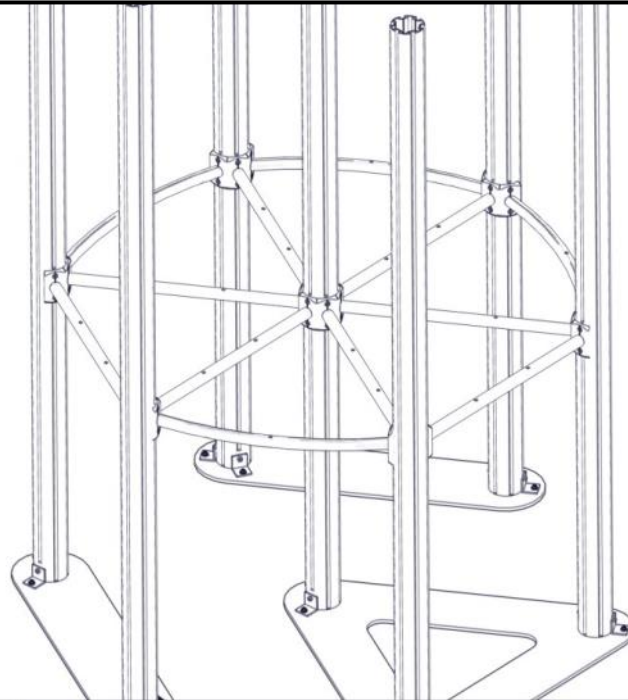

nr	PartName	Artnr	Antall
1	Torx M8x25	04-000-025	28
2	Sperrerør hull gulv	07-150-061	3
3	Sperrerør 6kant gulv 2 hull	07-500-064	4

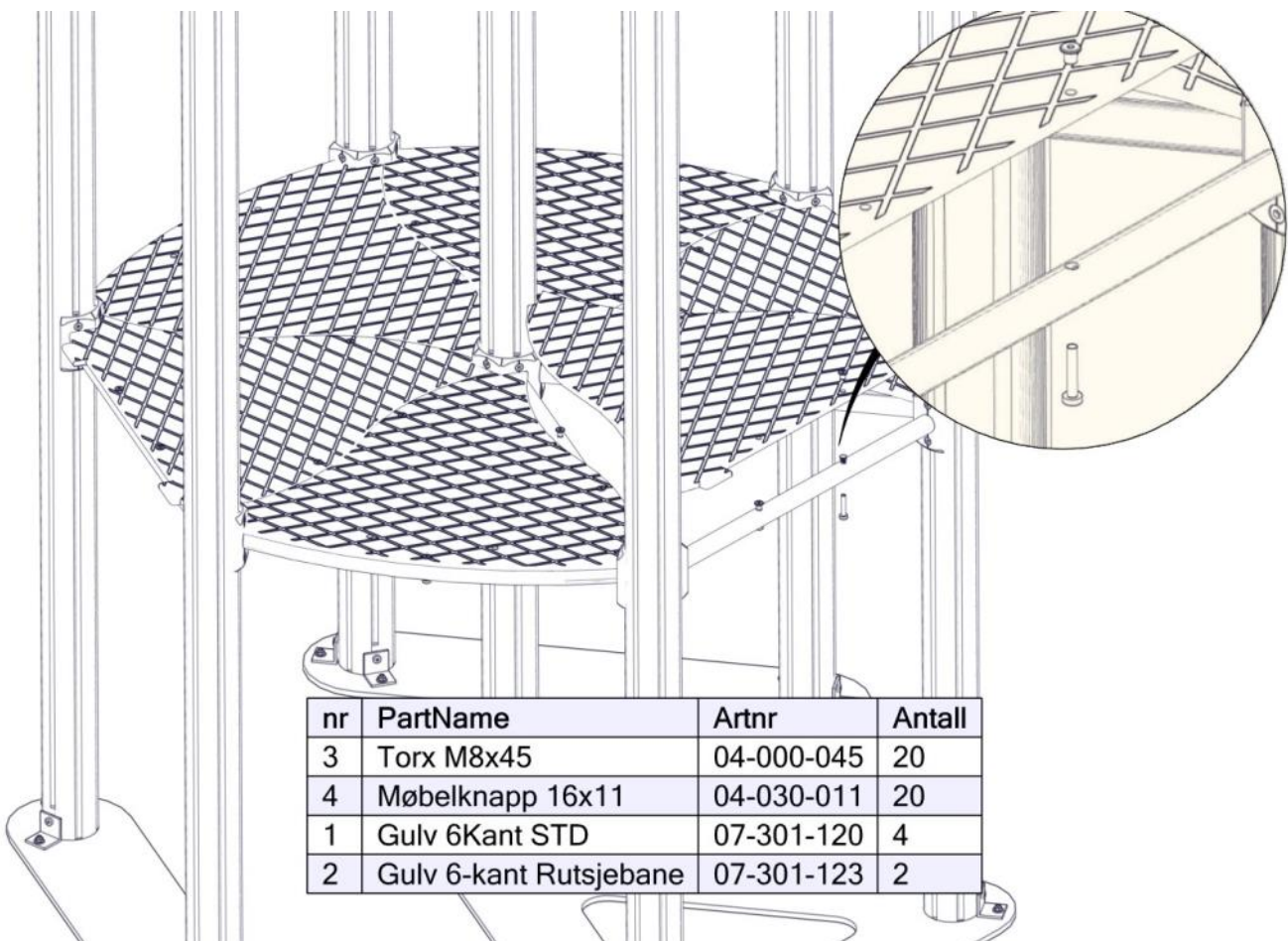

nr	PartName	Artnr	Antall
3	Torx M8x45	04-000-045	20
4	Møbelknapp 16x11	04-030-011	20
1	Gulv 6Kant STD	07-301-120	4
2	Gulv 6-kant Rutsjebane	07-301-123	2

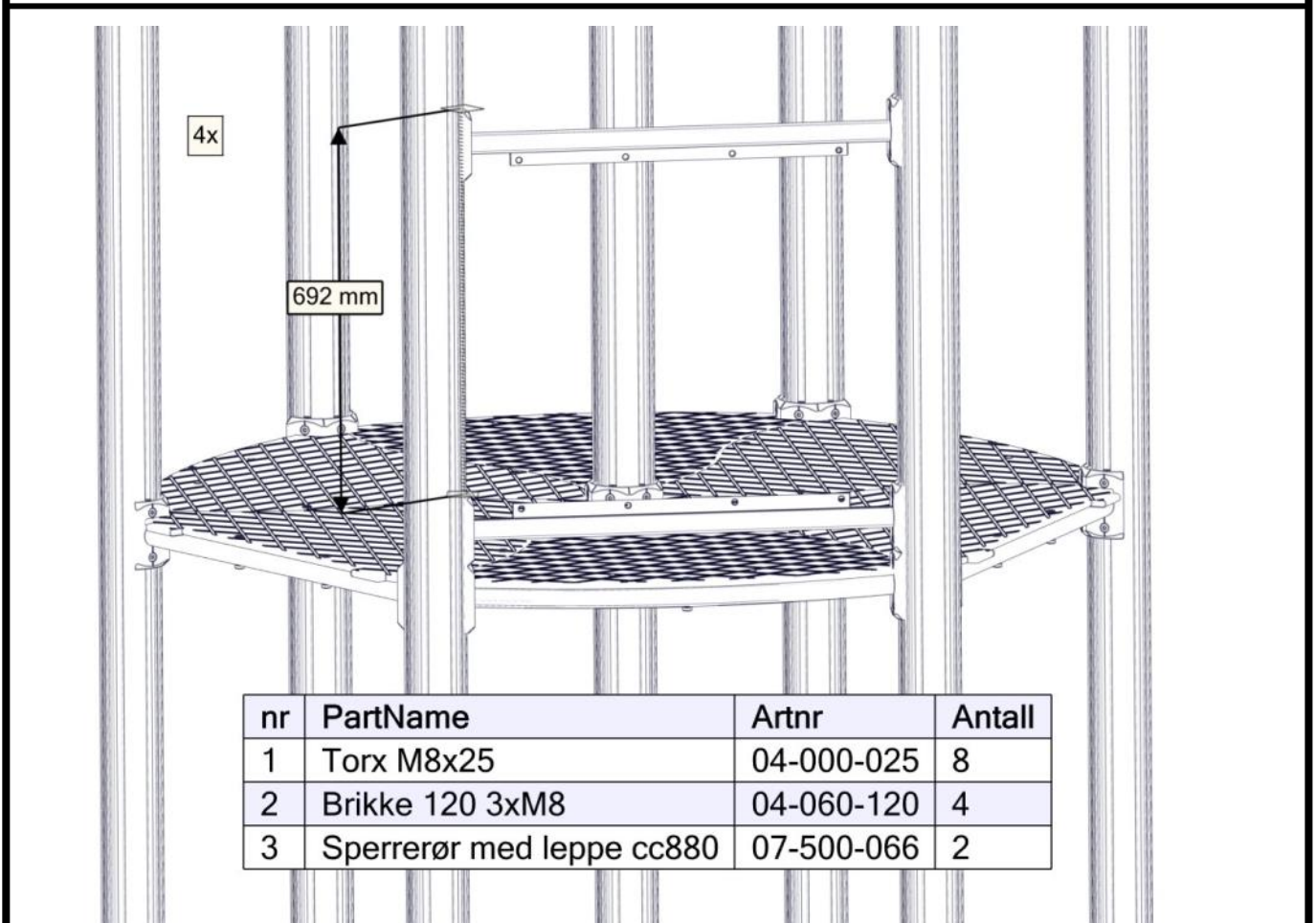
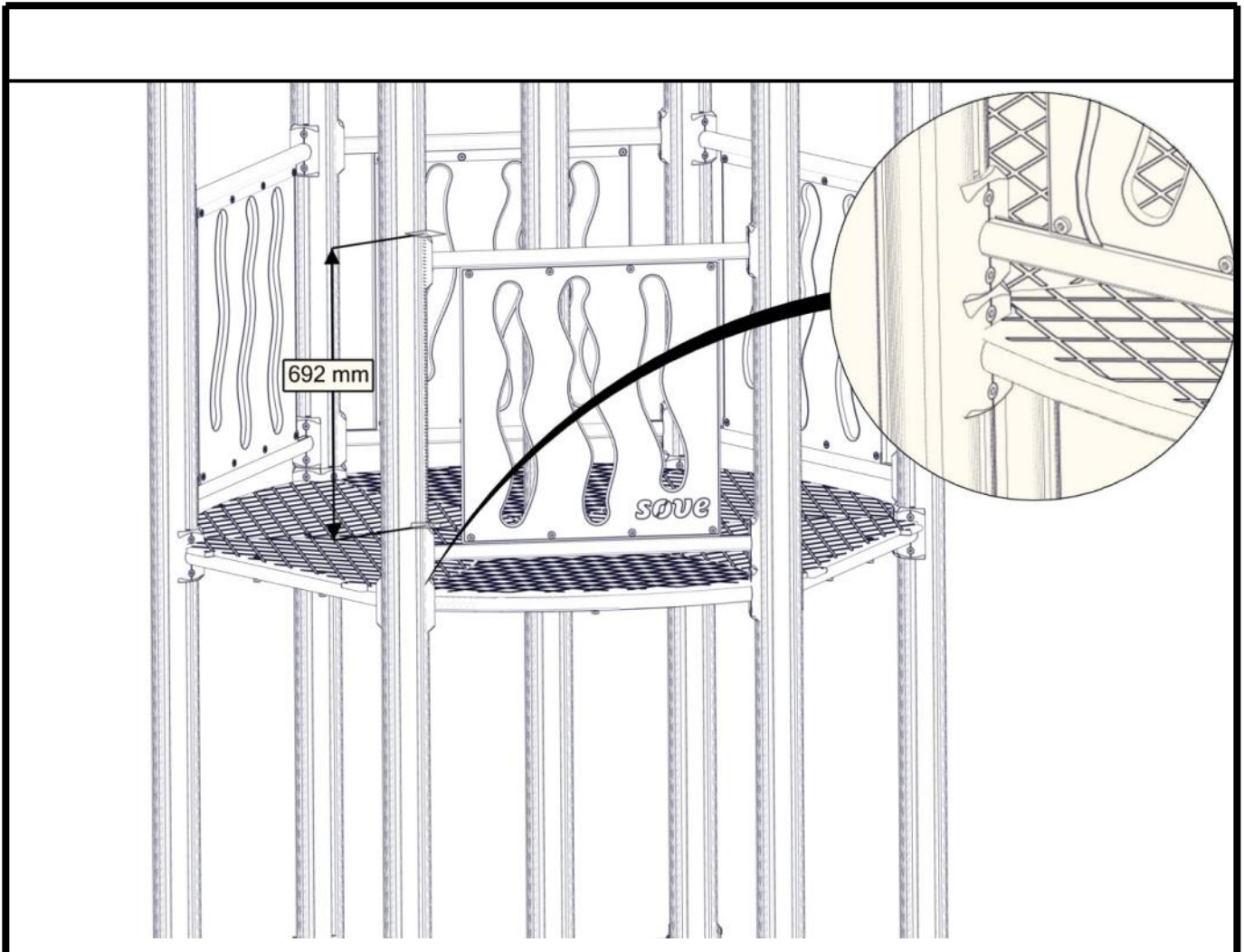

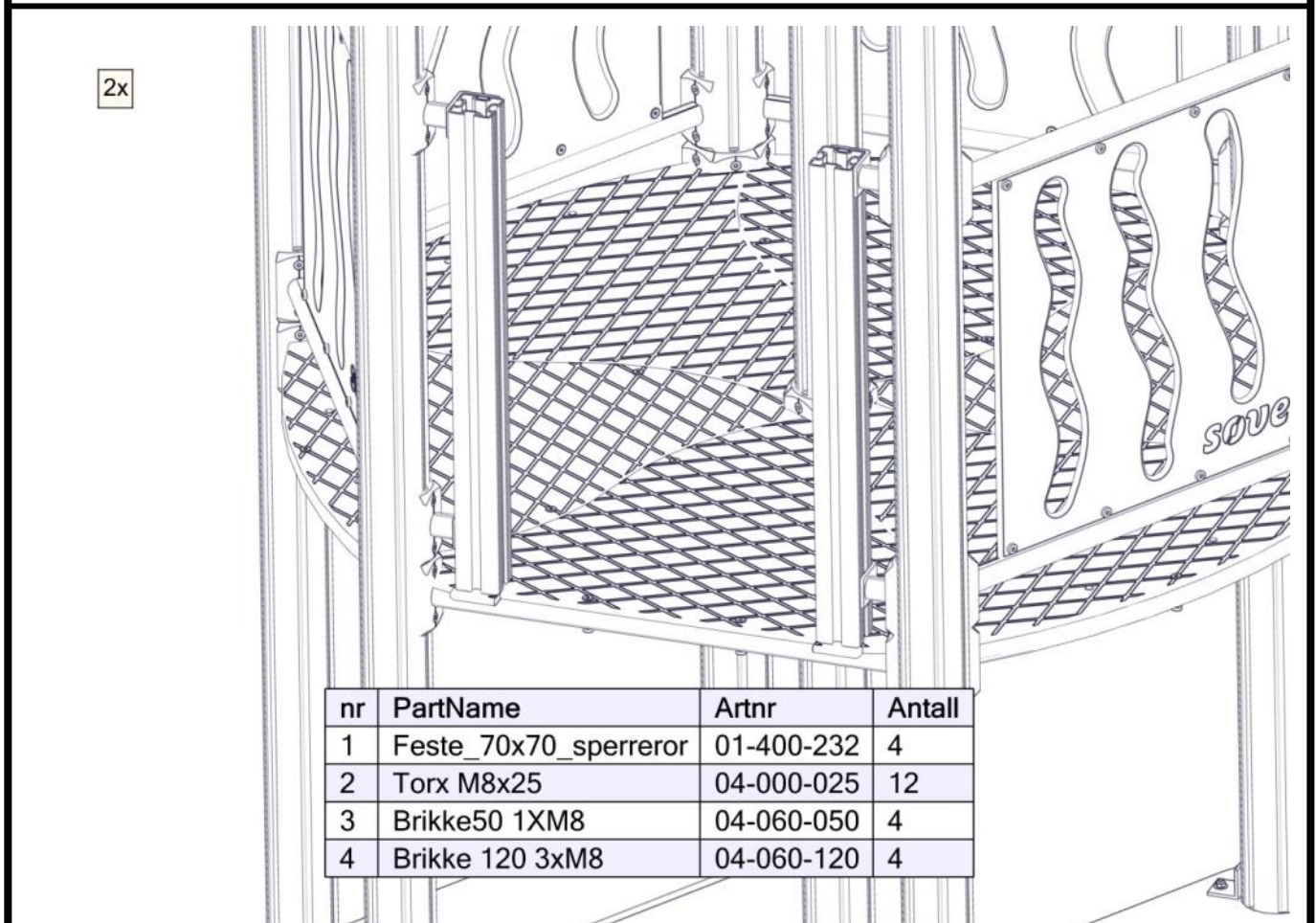
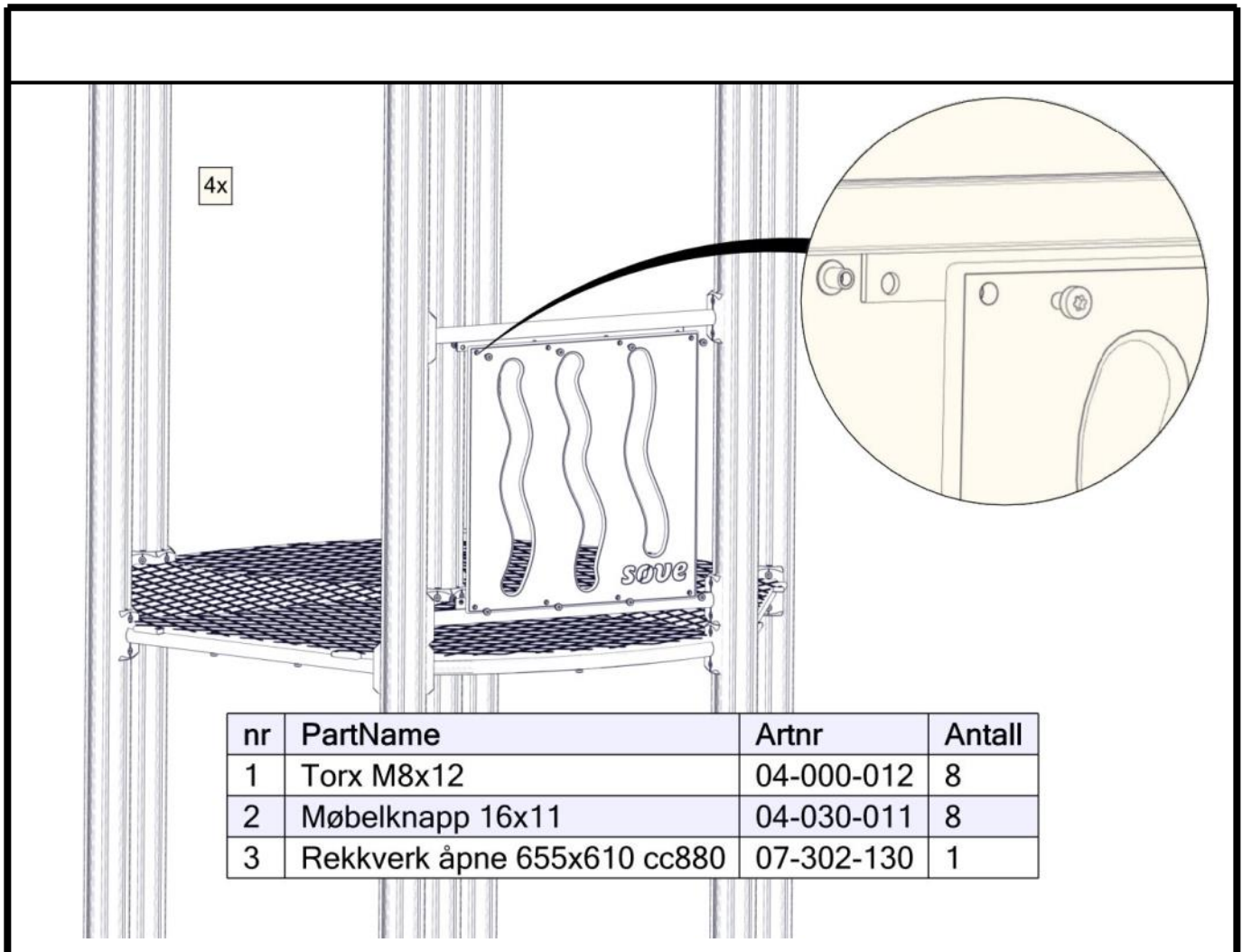

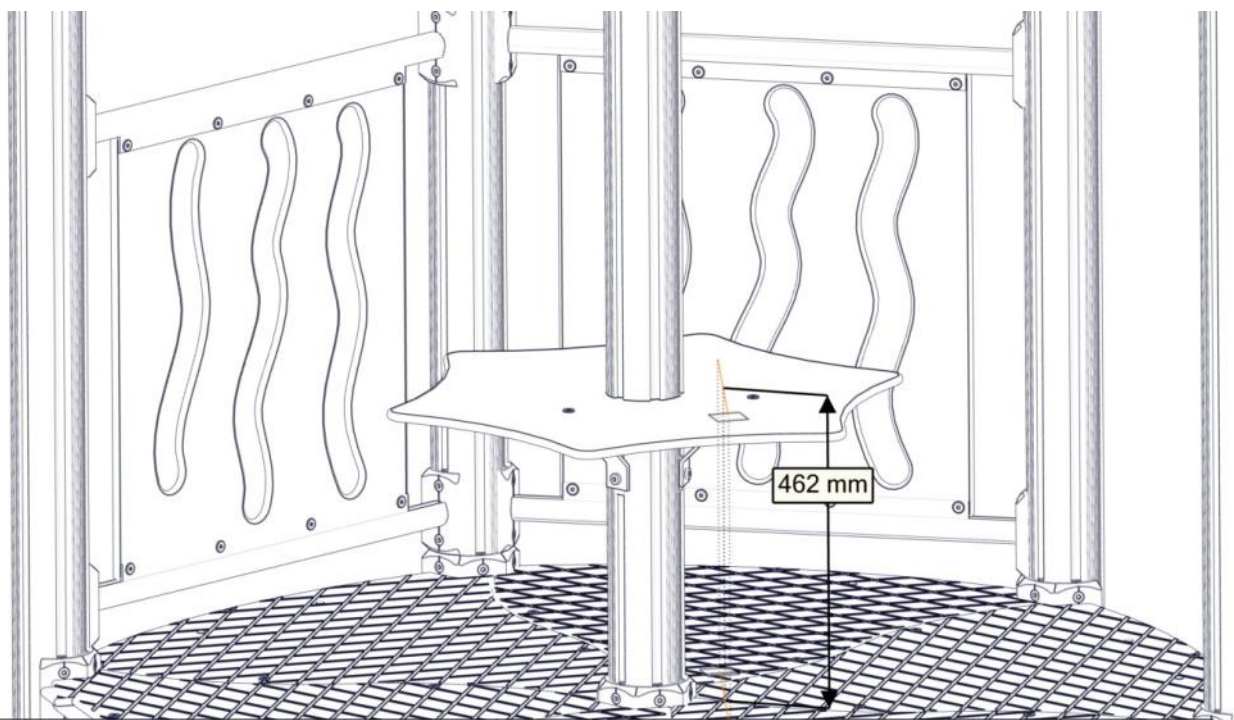

nr	PartName	Artnr	Antall	nr	PartName	Artnr	Antall
1	Torx M8x16	04-000-016	3	5	Brikke50 1XM8	04-060-050	3
2	Torx M8x20	04-000-020	3	6	Feste 45 gr 120x120x40x5	04-400-001	3
3	Møbelknapp 16x11	04-030-011	3	7	Bord 6Kant hus	07-520-605	1
4	Skive M8	04-050-008	3				

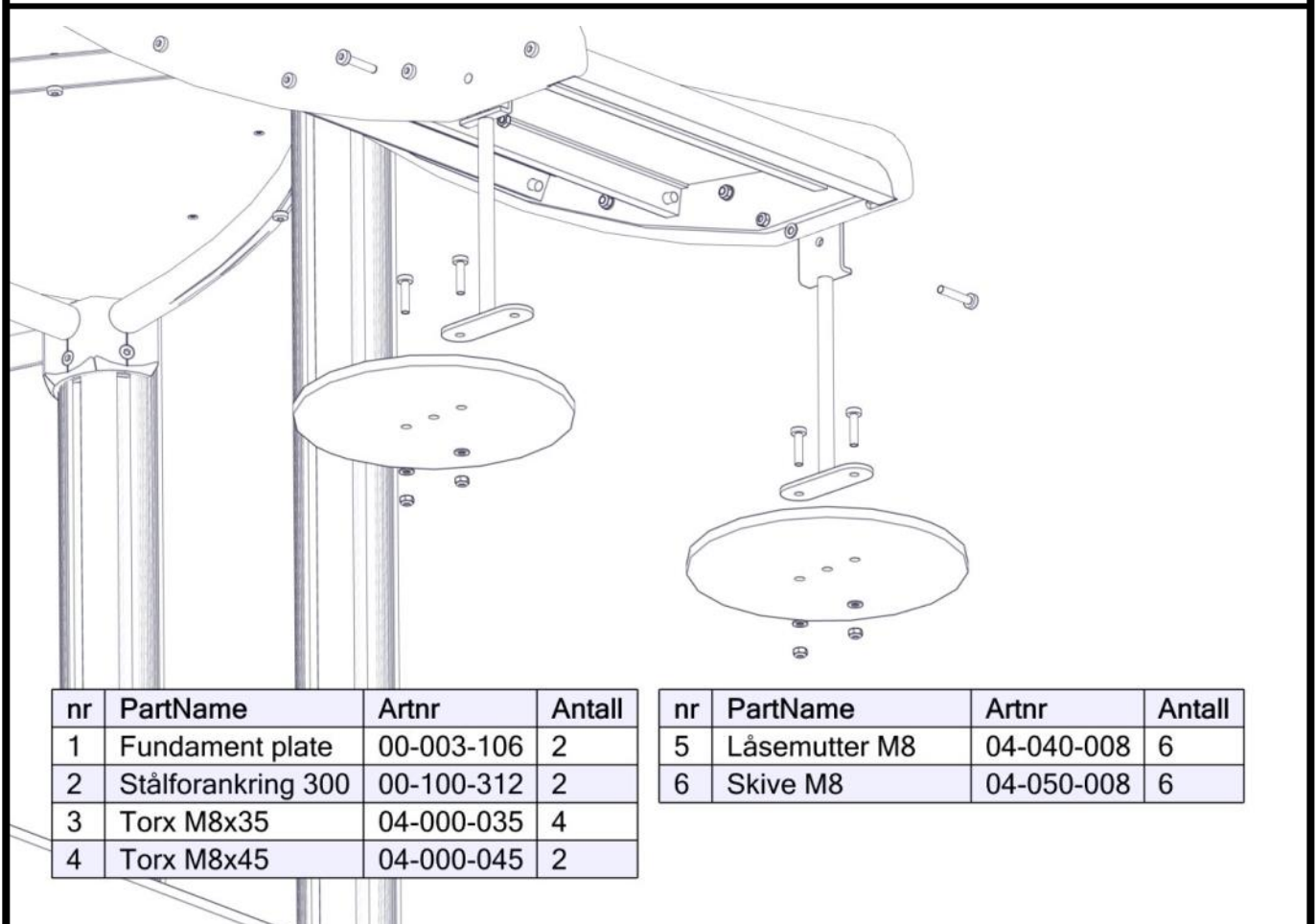
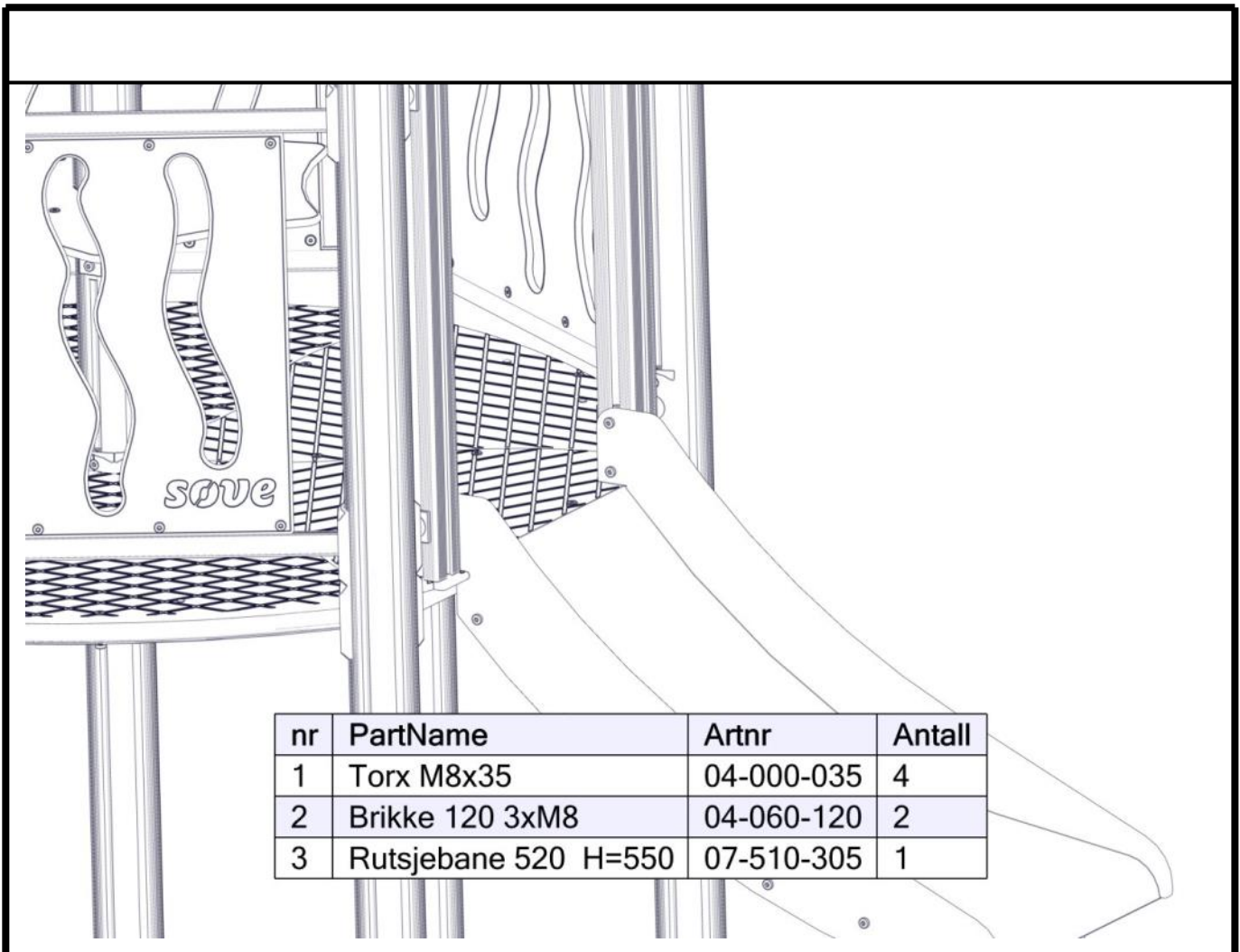

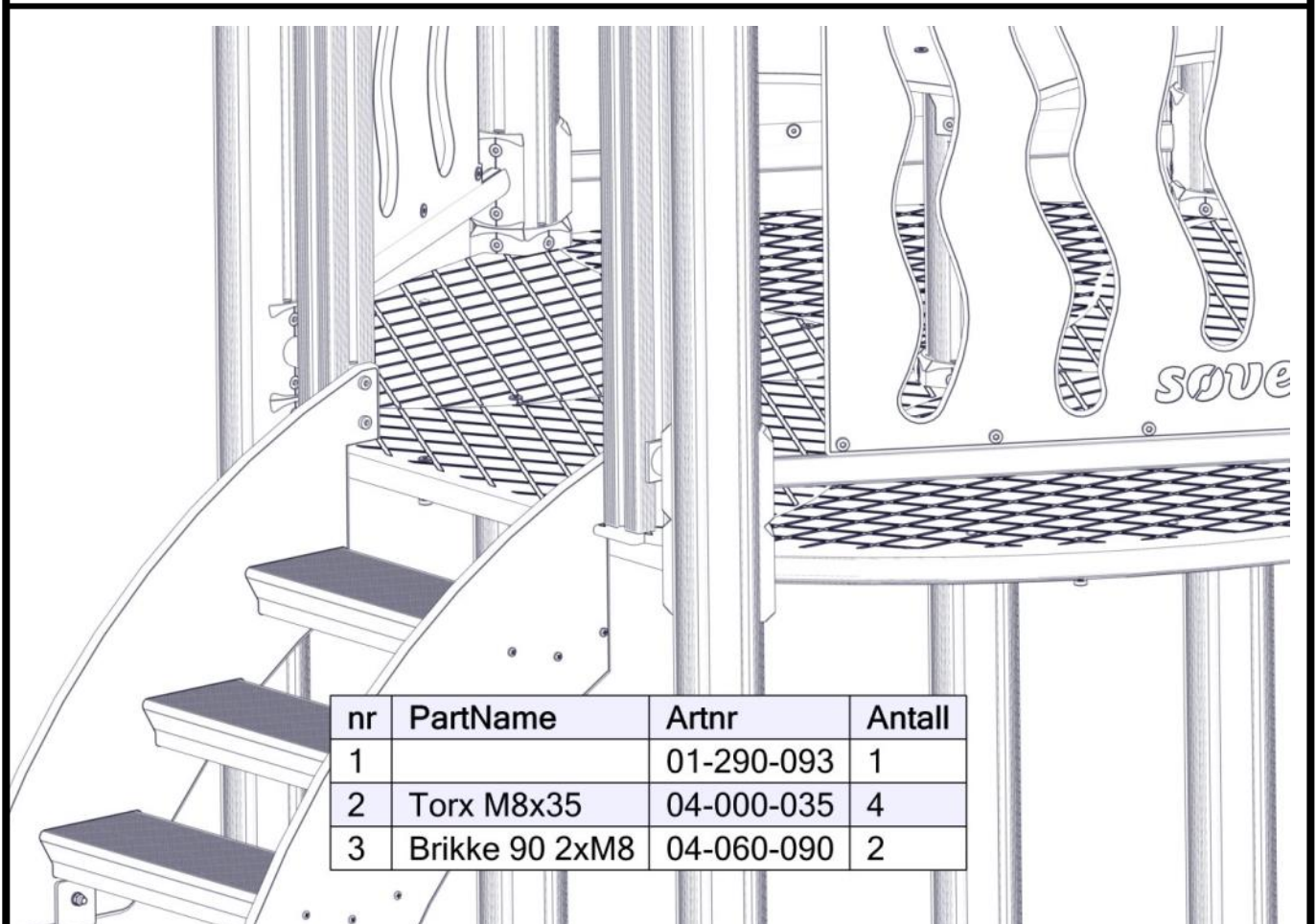
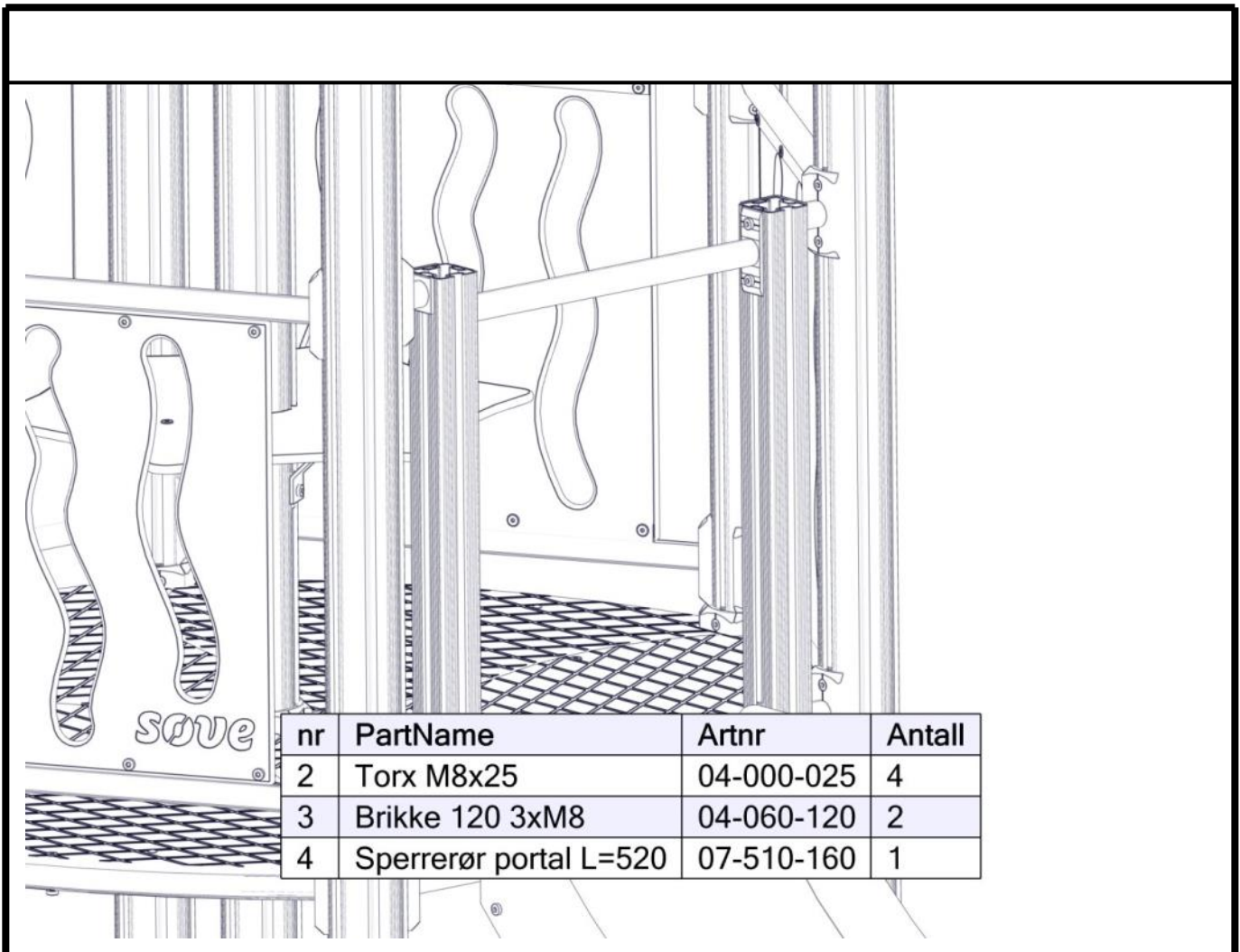

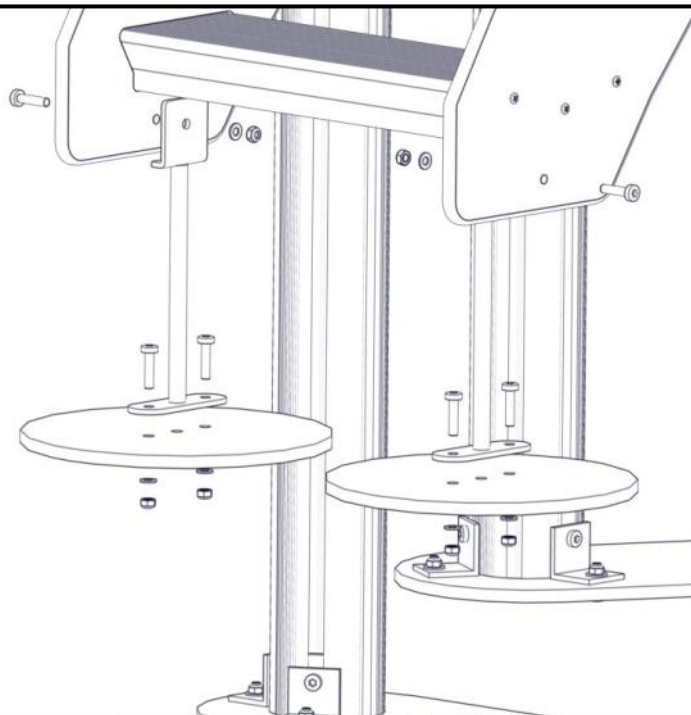

nr	PartName	Artnr	Antall	nr	PartName	Artnr	Antall
1	Fundament plate	00-003-106	2	4	Låsemutter M8	04-040-008	6
2	Stålforankring 300	00-100-312	2	5	Skive M8	04-050-008	6
3	Torx M8x35	04-000-035	6				

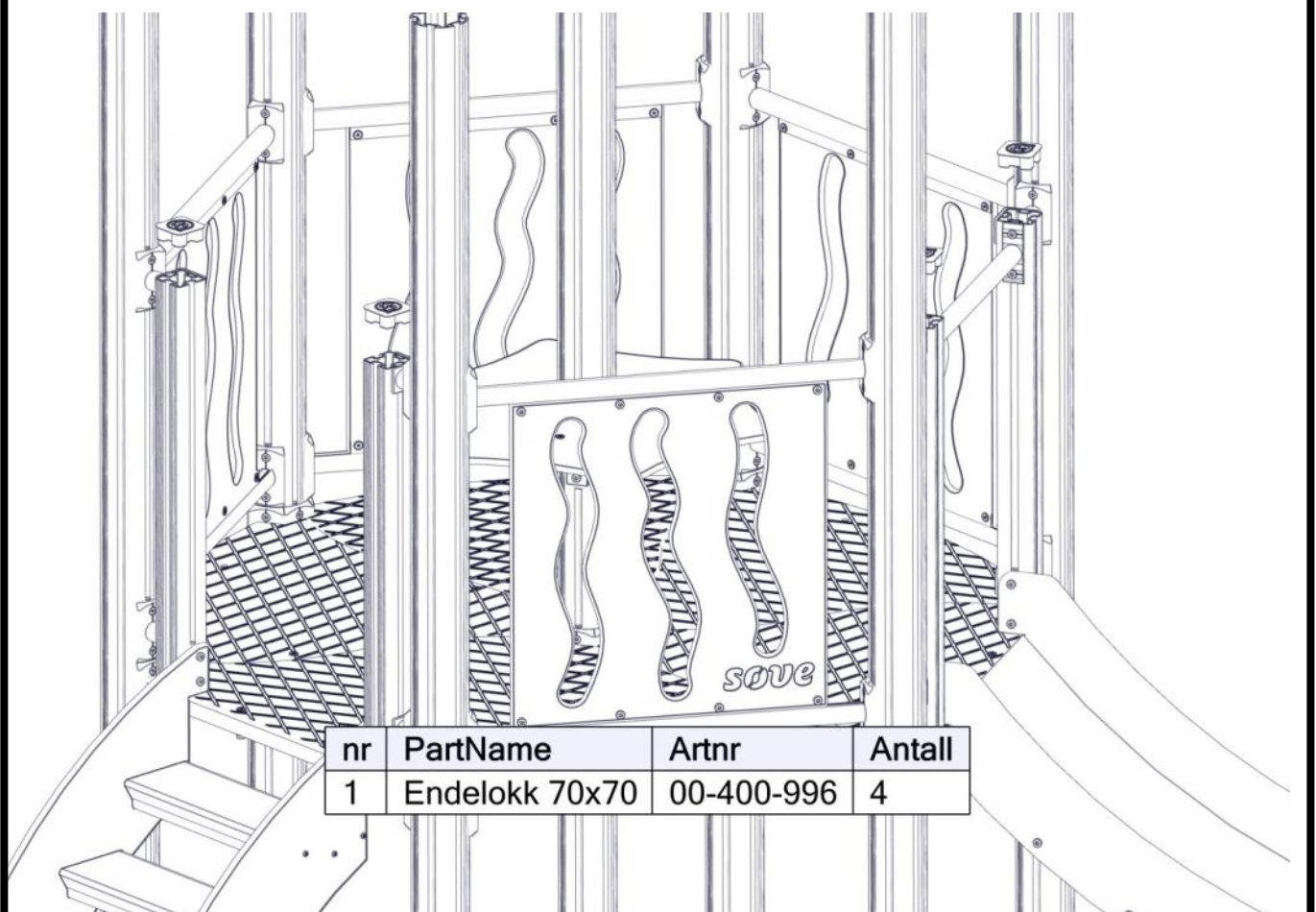



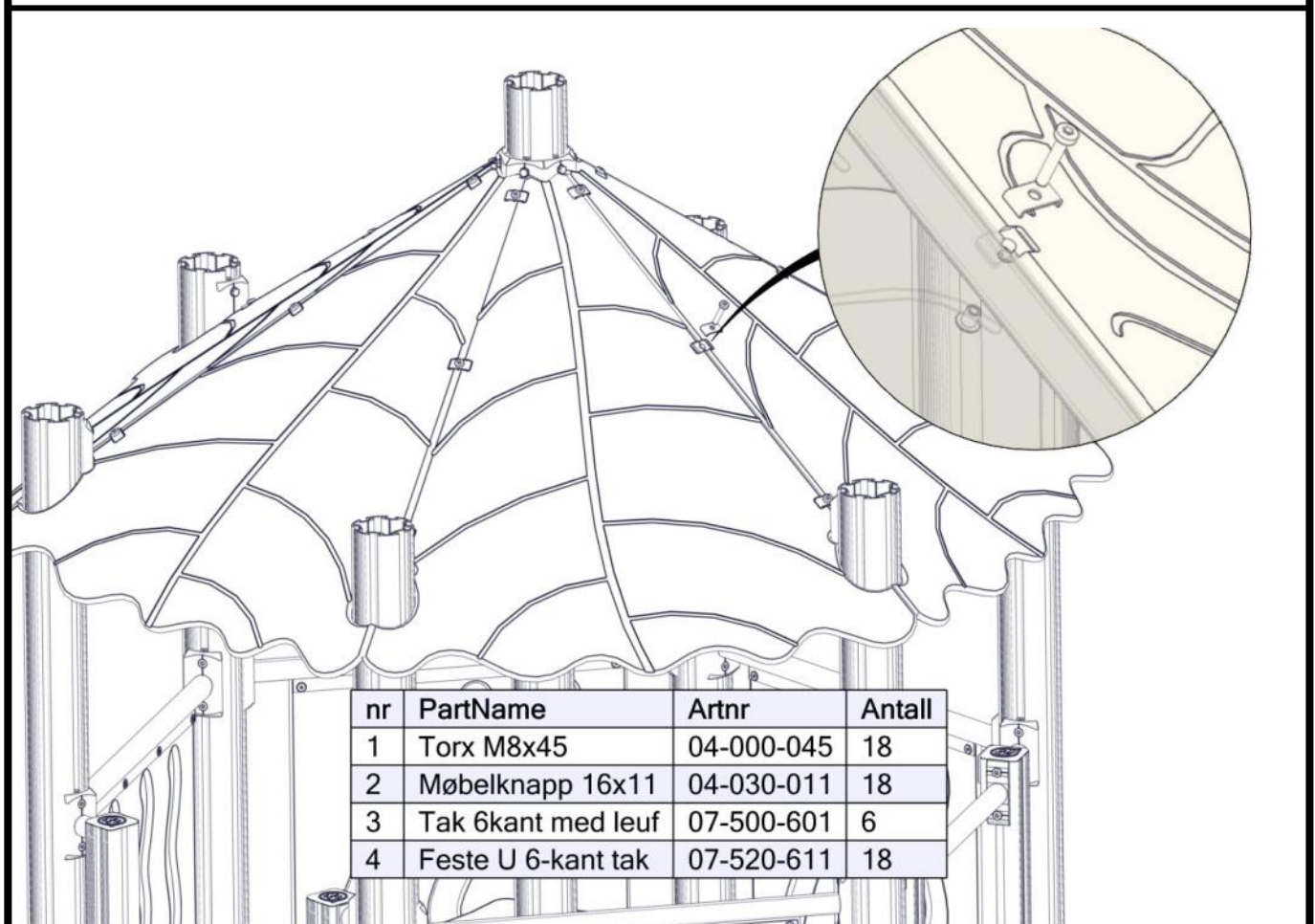
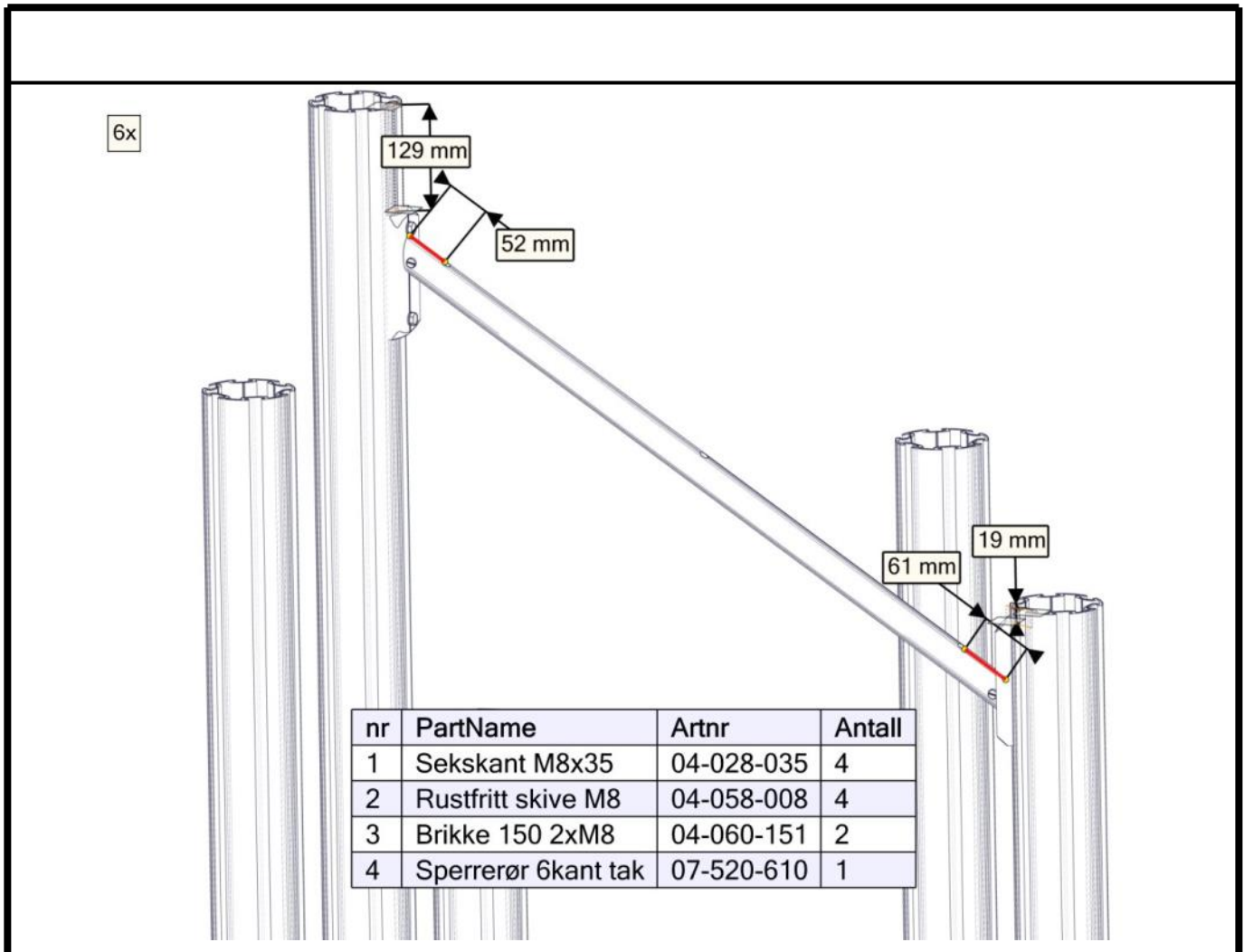

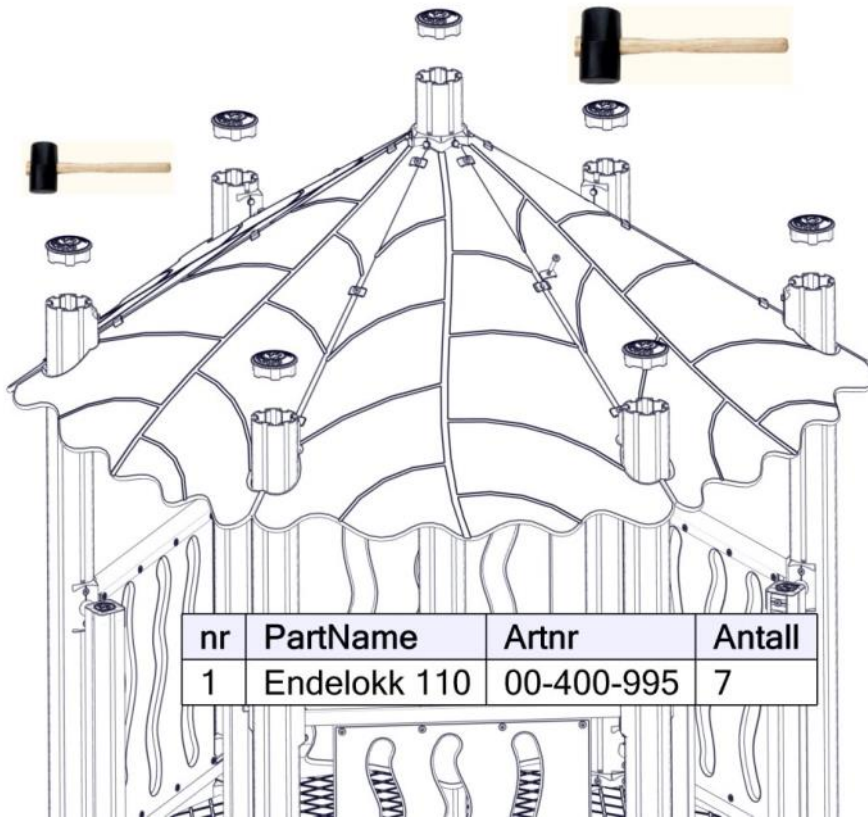







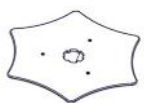
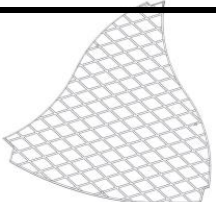

nr	PartName	Artnr	Antall
1	Endelokk 70x70	00-400-996	4







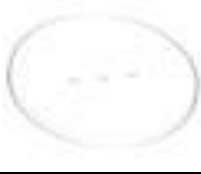
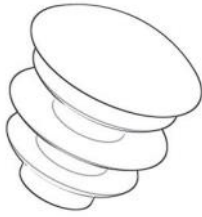





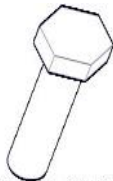
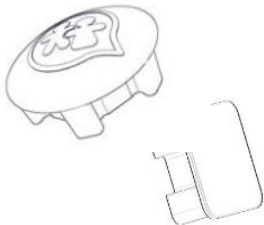

Før utstyret tas i bruk / Before play begins / Innan lekredskapet tas i bruk	
N	<ul style="list-style-type: none"> ● Påse at fallunderlag er utlagt i henhold til gjeldende regler eller vår anbefaling ● Fjern alle monteringshjelpemidler (rester av betong, planker, paller, plast, og lignende) ● Før utstyret tas i bruk, burde man sjekke at det ikke er fare for at anorakksnorer og lignende som kan hekte seg fast noen steder på lekeapparatet. (Vedlagte snor med dobbe (kneledd) kan brukes til å sjekke at dette er i orden. Se vedlagte veiledning for bruk av denne. Dette gjøres for å oppdage eventuelle feilmonteringer.?) ● NB! Bør stå i 2-3 dager før bruk
EN	<ul style="list-style-type: none"> ● Make sure the area and depth of safer surfacing are according to the current standard, or to the manufacturer's recommendation ● Make sure all tools and surplus materials are removed before play begins ● PS! When complete, allow 2-3 days for the concrete to set before use
S	<ul style="list-style-type: none"> ● Kontrollera att fallunderlag är utlagt enligt gällande regler eller vårt rekommendation ● Ta bort alla monteringshjälpmedel (rester av betong, plankor, pallar, plast och liknande) ● Innan lekredskapet används, kontrollera att anoracksnoddar eller kläder/delar av kläder eller liknande inte kan fastna i några delar på redskapet. (Den bipackade "knävringen" kan man med fördel användas för denna kontroll. ● Detta görs för att upptäcka eventuella felmonteringar.)

komponenter		Sign. _____.
	Dobbel funda- ment 07-400-002	2
	Sperrørør med leppe 07-302-110	8
	Vegg 655x610 Cc880 åpen 07-302-130	4
	6kant tak 07-500-600	6
	Sperrørør 6kant tak 07-150-064	6
	Feste U 6-kant tak 07520-611	18
	3kant fundament 07-400-003	1
	Bord rund 110 07-520-605	1
	Gulv 6kant STD brun 07-301-120	4
	Gulv 6kant rutsje brun 07-301-133	2
	Sperrørør 2hull 6kant 07-150-064	8
	Sperrørør Gulv 07-150-061	4

komponenter		Sign. _____.
	Rutsjebane H=550 07-510-305	1
	Trapp H=550 01-290-090	1
	Stålforankring 00-100-312	4
	Fundament kive 00-003-106	4
	Plast glugg 9-11mm	20
	Stolpe 110 L=2700 600-2100	6
	Stolpe 110 L=3250 600-2650	1

komponenter		Sign. _____				
	Torx M8x12 04-000-012	39		Brikke 50-1T 04-060-050	25	
	Torx M8x20 04-000-020	3		Brikke 90-2T 04-060-090	2	
	Torx M8x25 04-000-025	122		Brikke 120-3T 04-060-120	28	
	Torx M8x30 04-000-030	14		Brikke 150-2T 04-060-151	13	
	Torx M8x35 04-000-035	18				
	Torx M8x45 04-000-045	38				Møbelknapp 04-030-011
	Skive M8 04-050-008	9		Vinkel 50x50x50x5	14	
	Skive M8 stor 04-055-008	28		04-070-050		
	Skive M8 rustfritt 04-058-008	24				
	Sekskant M8x35 Rustfritt 04-058-008	24		Endelokk 00-400-995	7	
				Endelokk 70x70 00-400-996	4	
	Produktmerke 07-500-500	1		Låsemutter M8 04-040-008	26	
	Feste portal 01-400-231	8		Feste 45gr 120x120x40x5	3	
				04-400-001		
	Stolpe 70x70 L=820	4		Sperrerør portal L=520	1	
				07-510-160		