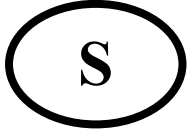

**Monteringsanvisning****Assembly Instructions****Monteringsanvisning**

Produkt nr. / Product no. / Produkt nr.

**30-200-132**

rød

Ord. nr. \_\_\_\_\_

Dato. \_\_\_\_\_

Sign. \_\_\_\_\_

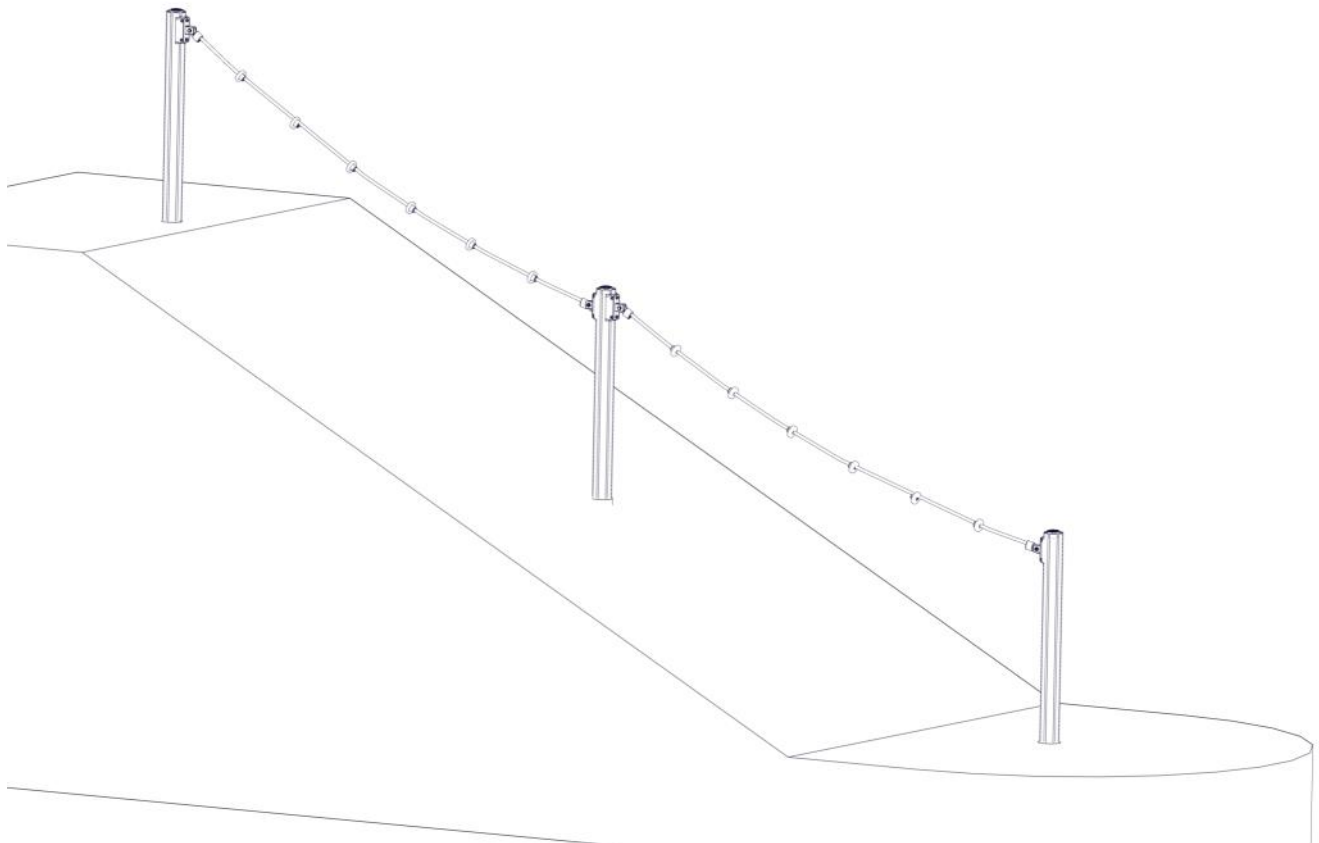
**søve**

Søve AS  
Grønnvoldveien 290  
3830 Ulefoss - Norway  
Tlf: +47 35 94 65 65  
[www.sove.no](http://www.sove.no)

**søve**

Søve AB  
EA Rosengrensgatan 32  
421 31 Västra Frölunda  
Phone: +46 (0)31 773 97 00  
[www.sove.se](http://www.sove.se)

## Monteringstips / Assembly Advice / Monteringsstips

N

- Les monteringsanvisningen nøye før montering.
- Monter elementene i rekkefølgen som vist.
- Boltene bør ikke skrues for hardt til før alt er montert, vatret og loddet. Skru så boltene til.
- NB! Ved bruk av drill, kan boltene ryke.
- På grunn av at solen kan gjøre rutsjeflaten veldig varm, bør rutsjebanens utløp vende mot nord-øst eller nord-vest.
- Er lekeutstyret plassert i naturlige ferdselstraséer må området sikres mot gjennomgang.
- Innspringningshinder bør vurderes rundt lekeapparater hvor det er stor bevegelse, f.eks. ved huskestativ.
- Det bør være fritt innsyn til lekeutstyr som er beregnet for barn under 3 år.

**NB! Under monteringsarbeidet må utstyr, som ikke er forankret forsvarlig i bakken, sikres slik at det ikke velte.**

**Området må avstenges under montering av apparatene med sperrebånd eller lignende.**

EN

- Read the instruction carefully before assembling the play unit.
- Assemble the components in the sequence shown in these instructions. Fixings must not be fully tightened during assembly. Before casting the foundations, the structure must be level and plumb, at which point all fixings are tightened. PS! If use of drill, the bolts may be wrecked.
- Avoid positioning the slide facing due south because of overheating – ideal positions are facing north-east or north-west. Secure the construction-area to prevent people from walking through it.
- Consider installing barriers around play-equipment which gives rise to a lot of activity – i.e. swings.
- Ensure that clear vision is possible across the play area so that supervision is possible from any position, particularly where children under 3 years of age will be playing.

**NB! During assembly of the equipment, ensure that all structures are securely propped, especially when left overnight. Also ensure that equipment is supported**

**Monteringstips / Assembly Advice / Monteringsstips****S**

- Läs monteringsanvisningen noga före montering.

- Montera delarna i den ordningen som anvisas
- Skruvarna bör inte skruvas för hårt tills allt är monterat, i våg och lodat.

OBS! Används elektrisk skruvdragare, kan bulten gå sönder. Hårdra därför manuellt!

- Solen kan göra att rutchbanan blir väldigt varm. Banans nedfart rekommenderas att vändas i norrlig riktning
- Om lekplatsen placeras vid en gångväg mm bör området säkras mot genomfart av gående och cyklister.
- Insprängningshinder bör placeras runt lekutrustning med stor rörelse, t ex, gungställning.
- Det bör vara fri insyn till lekutrustning beräknat till barn under 3 år.

**OBS! Under monteringsarbete bör utrustningen som inte ska förankras i marken, ställs så att den inte kan välta.**

**Området måste spärras när lekutrustningen byggs upp, med avspärrningsband eller liknande.**

NO	Betongkvalitet	C25/30		
SE	Betongkvalitet			
EN	Concrete quality			
NO	Mengde betong		0,45	m <sup>3</sup>
SE	Mängd betong			
EN	Amount of concrete			
NO	Fundament størrelse		3x 0,5 x 0,5 x 0,6	m
SE	Stiftelsestorlek			
EN	Foundation size			
NO	For sikkerhet må fundamentene med sand eller myk jord være minst 50% større i areal			
SE	För säkerheten måste grunden med sand eller mjuk jord vara minst 50% större i området			
EN	For safety, the foundations with sand or soft soil must be at least 50% larger in area			
NO	Tyngste element	SFA5126	7,9	Kg
SE	Tyngsta element			
EN	Heaviest element			
NO	Største element	SFA5126	1,8 x 0,1	m
SE	Största element			
EN	Biggest element			



Bolten skrues HELT igjennom aluminiumen.







The bolt must be tightened in to the post, so that it pierces the aluminium

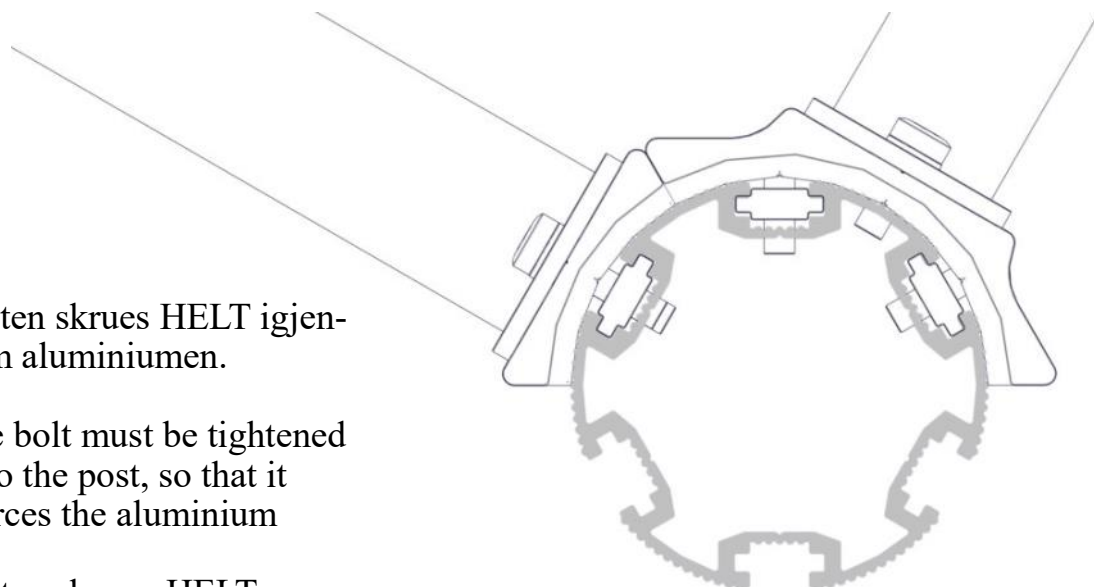

Bulten skruvas HELT igjennom aluminiumen.



**Nødvendig verktøy / Tools required / Nödvändiga verktyg**

<p>(N)</p> <p>(EN)</p> <p>(S)</p>	<p>(A)</p> 	<p>(B)</p> <p>Metermål Metric measure Tumstock</p> 	<p>Merkebånd Mark ribbon Märkeband</p> 	<p>(D)</p> 	<p>(E)</p>
-----------------------------------	--	--	---	--	------------

**Nødvendig antall personer / Number of persons required / Rekommenderad antal personer**

<p>(N)</p> <p>(EN)</p> <p>(S)</p>	
-----------------------------------	---

**Anbefalt arealbehov ved montering / Recommended working space / Rekommenderad arealbehov vid montering**

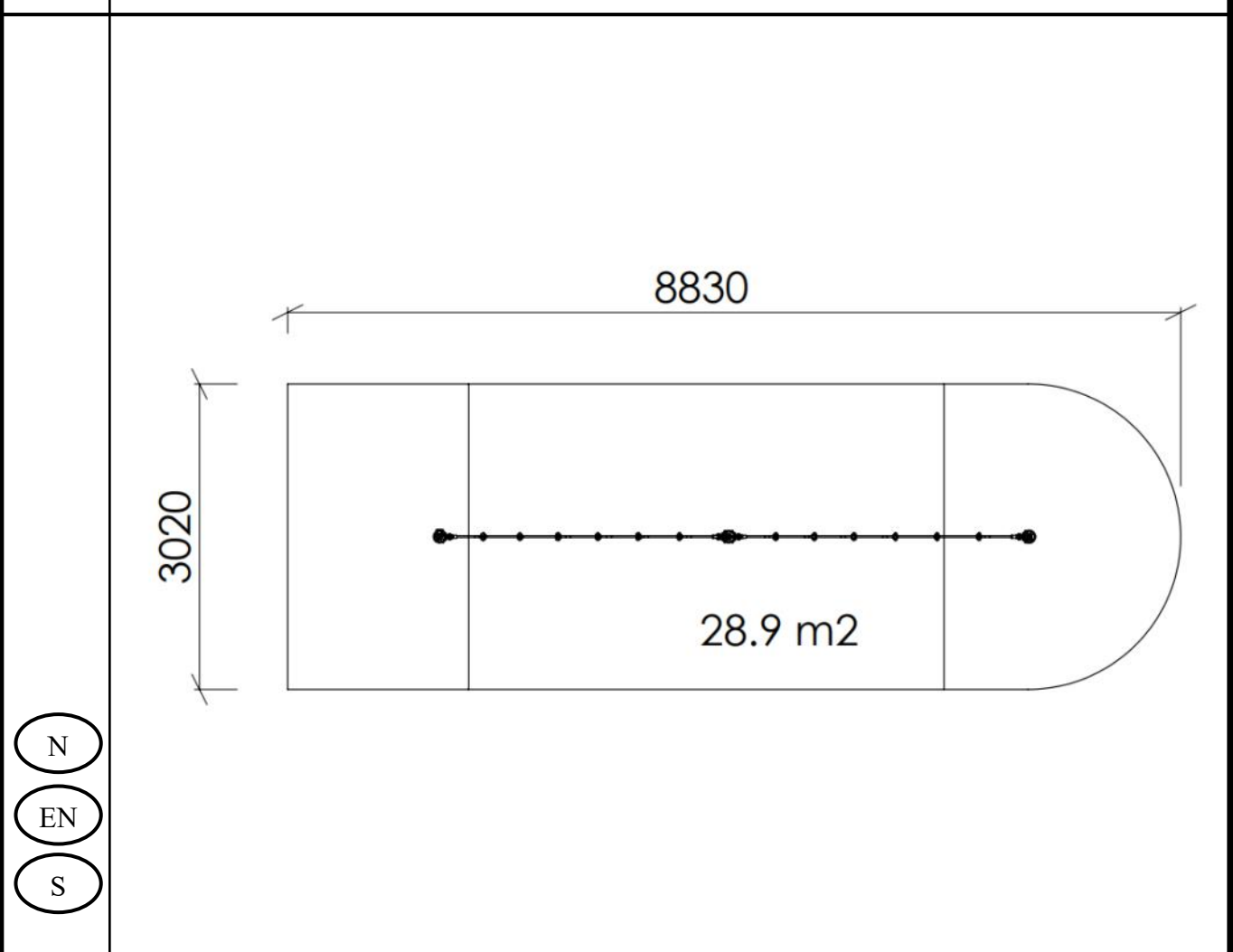

# Fundamenteringa med betong / Foundation concrete / Förankring med betong

- (N) Støtdempende materialer
- (EN) Impact attenuating materials
- (S) Støtdämpande material Ref NS-EN 1176-1 §4.2.8.5

- (N) Bakkenivå
- (EN) Ground level
- (S) Marknivå

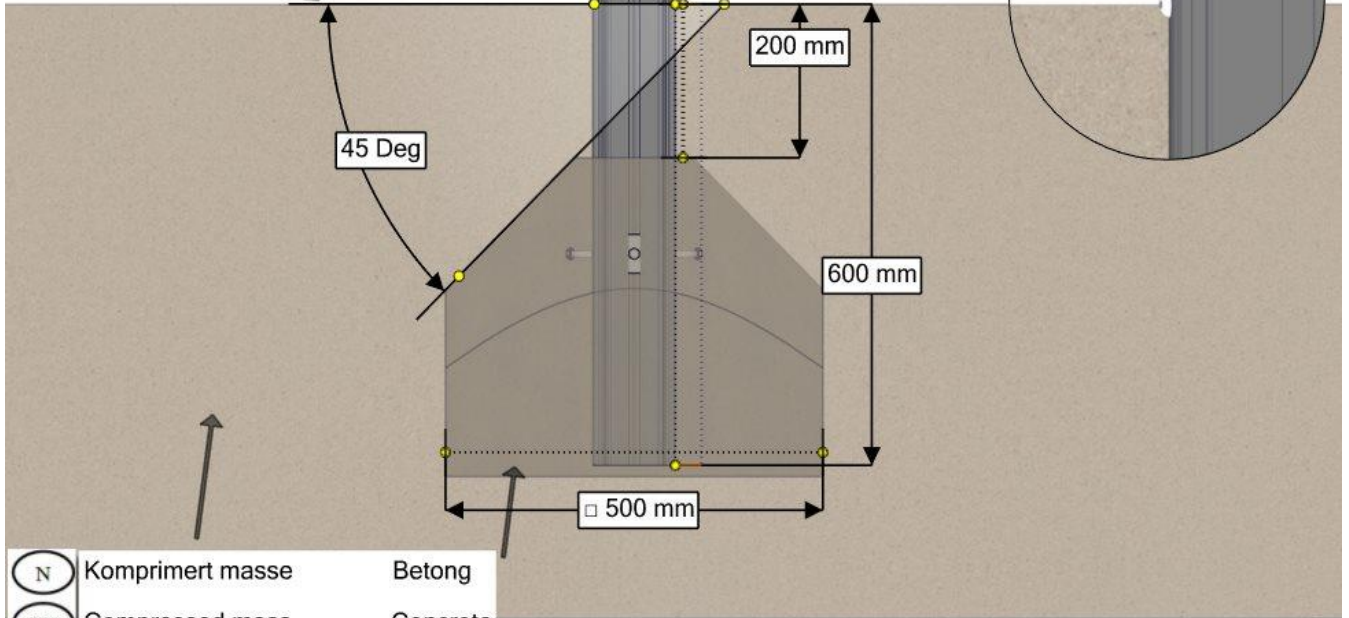
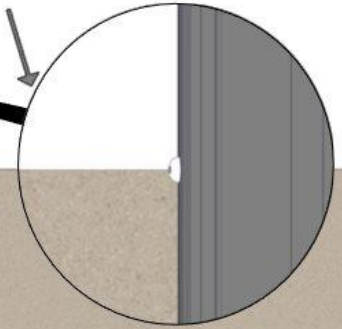



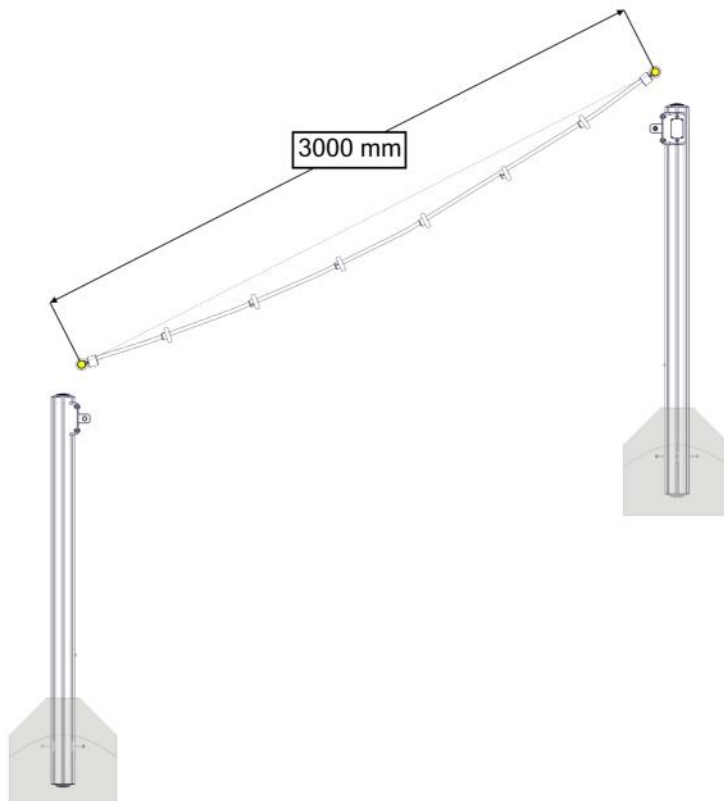

- (N) Komprimert masse Betong
- (EN) Compressed mass Concrete
- (S) Komprimerad massa Betong



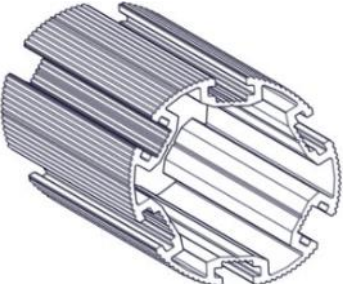

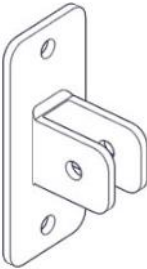



**Boltepakker for / Boltpackage for / Bultpaket för**

Sign. \_\_\_\_\_

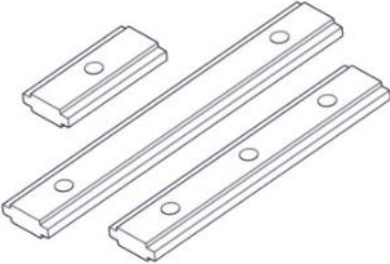
Opptrekstau med 3stolpe L=3000, rød, 30-200-132	Navn	Artnr/ dimensjon	Ant	Lev
	Opptrekstau til 2 stolpe rød L=3000	00-104-536	2	
	Stolpe Ø110 L=1800 (600-1200) Grå	SFA5126/2	3	
	Stolpelokk Ø110	00-400-995	3	
	Produktmerke Med beslag til Ø110 stolpe	07-500-500 (se egen delmontering)	1	
	Beslag Små timble Horizontal	07-200-051	4	
	Beslag 30gr, L=150 4hull, 2 gjenge	07-150-041	4	

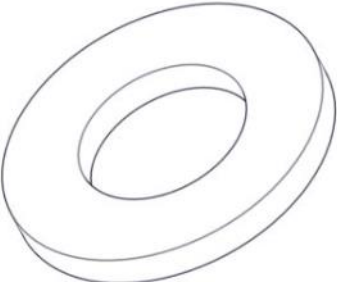
**Boltepakker for / Boltpackage for / Bultpaket för**

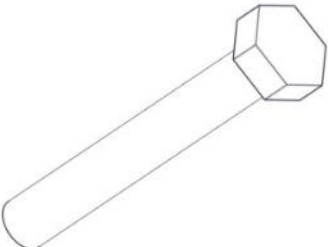
Sign. \_\_\_\_\_

Opptrekstau med 3stolpe L=3000, rød, 30-200-132	Navn	Artnr/ dimensjon	Ant	Lev
	Brikke alu 150x8x23 m/ 2hull	04-060-151	8	
	Torx skrue M8x25	04-000-025	24	
	Skive M8 Skive M10	04-050-008 04-050-010	8 8	
	Låsemutter M10	04-040-010	4	
	Sekskant skrue M10x45	04-010-045	4	
	Fundament Betong 110 lokk_bolter_brik	00-003-111K (se egen delmontering)	3	

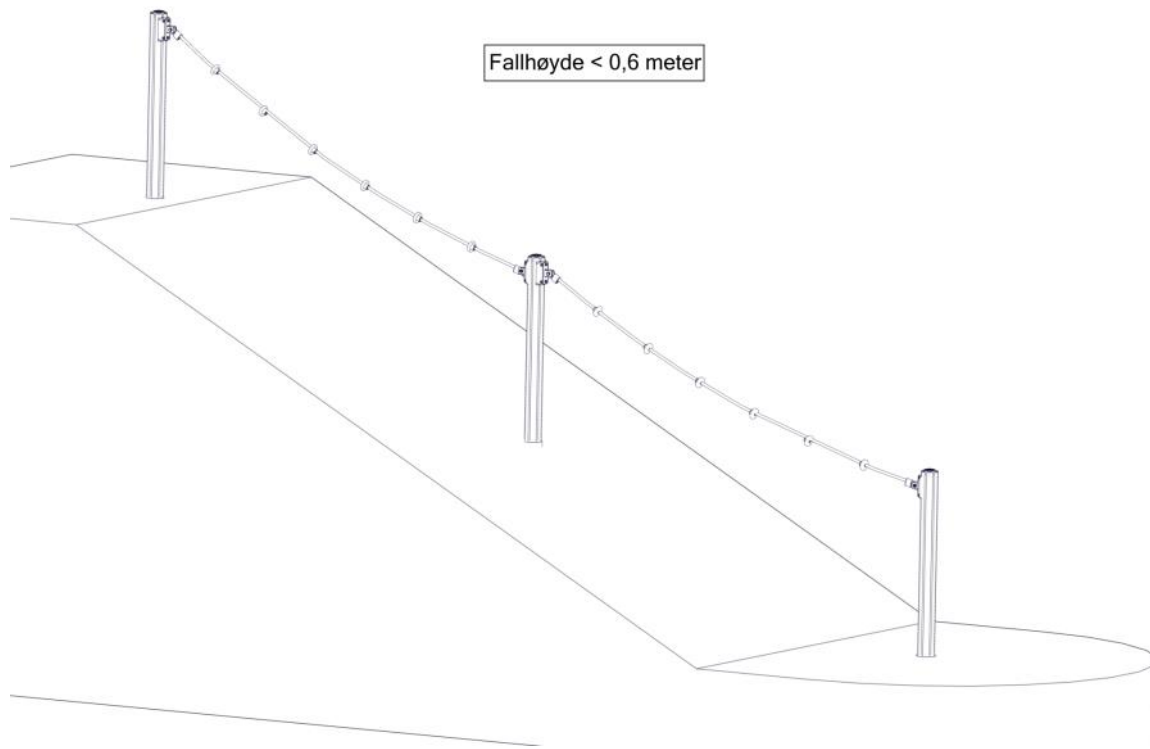
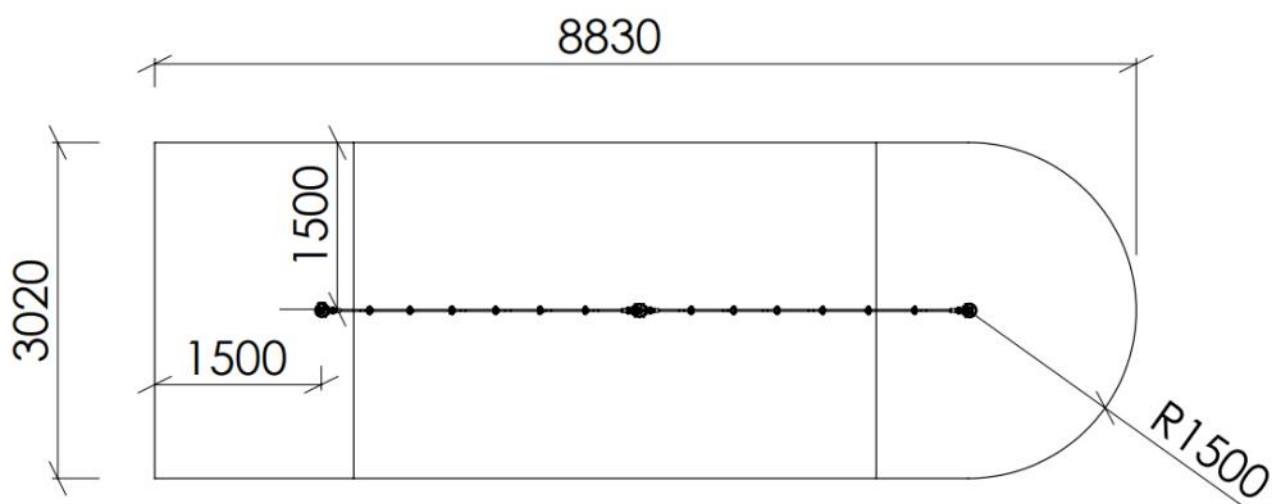

**Fallhøyder / Free height of fall / Fallhöjder****Sikkerhetszone / Safety zone / Säkerhetszon**

## Montering av lekeapparatet / Assembly instructions / Montering av lekredskapet

Se separat delmontering for detaljer  
 See separate assembly for details  
 Se separata delmontering för detaljer

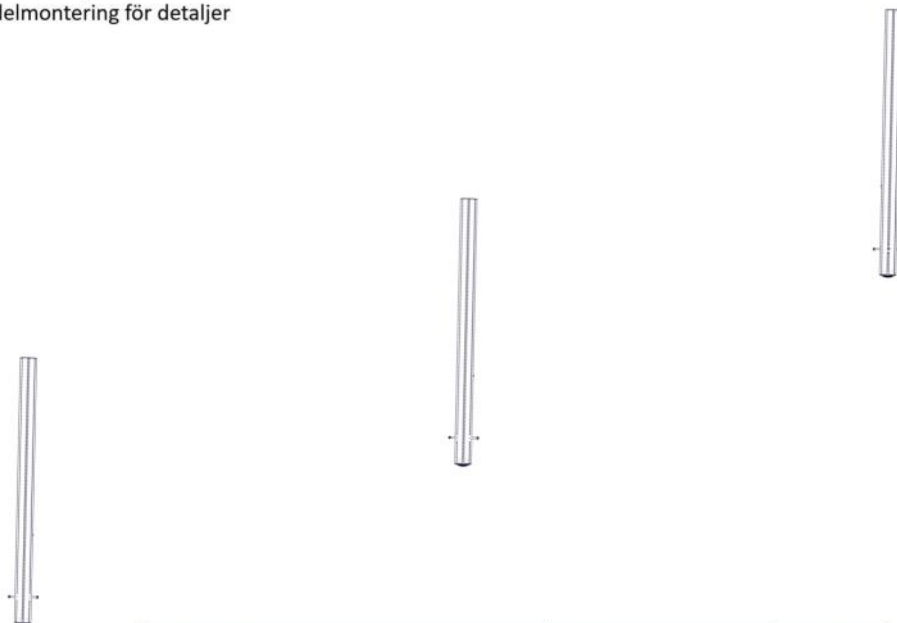

PartName	Artnr	Antall
Stolpe Ø110 L=1200-600	SFA5126/2	3
Støpe fundament Ø 110	00-003-111K	3

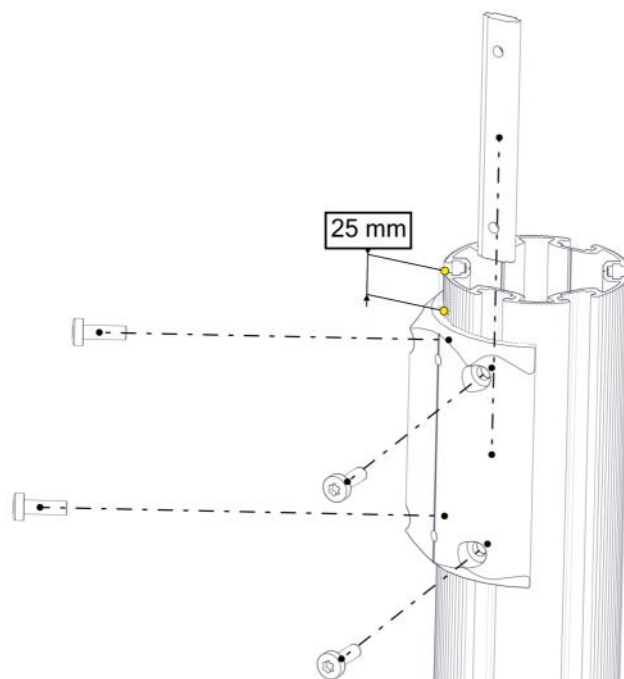

PartName	Artnr	Antall
Beslag 30gr 150 4xhull 2xM8	07-150-041	4
Brikke 150 2xM8	04-060-151	8
Torx M8x25	04-000-025	16

## Montering av lekeapparatet / Assembly instructions / Montering av lekredskapet

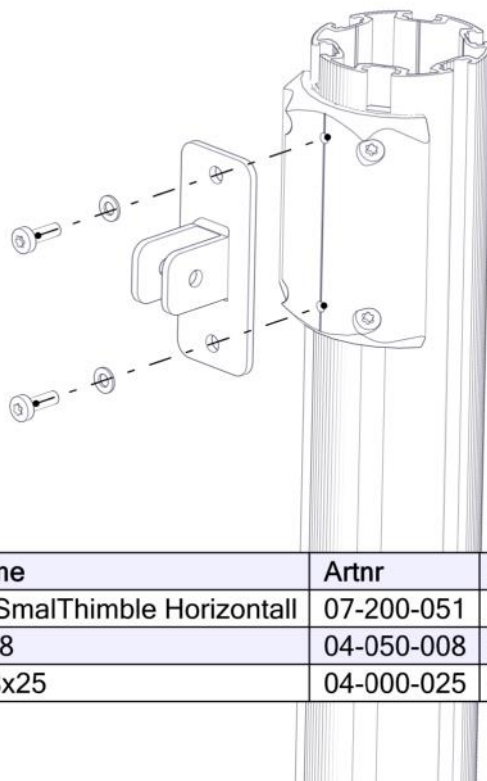

PartName	Artnr	Antall
Besalg SmalThimble Horizontal	07-200-051	4
Skive M8	04-050-008	8
Torx M8x25	04-000-025	8

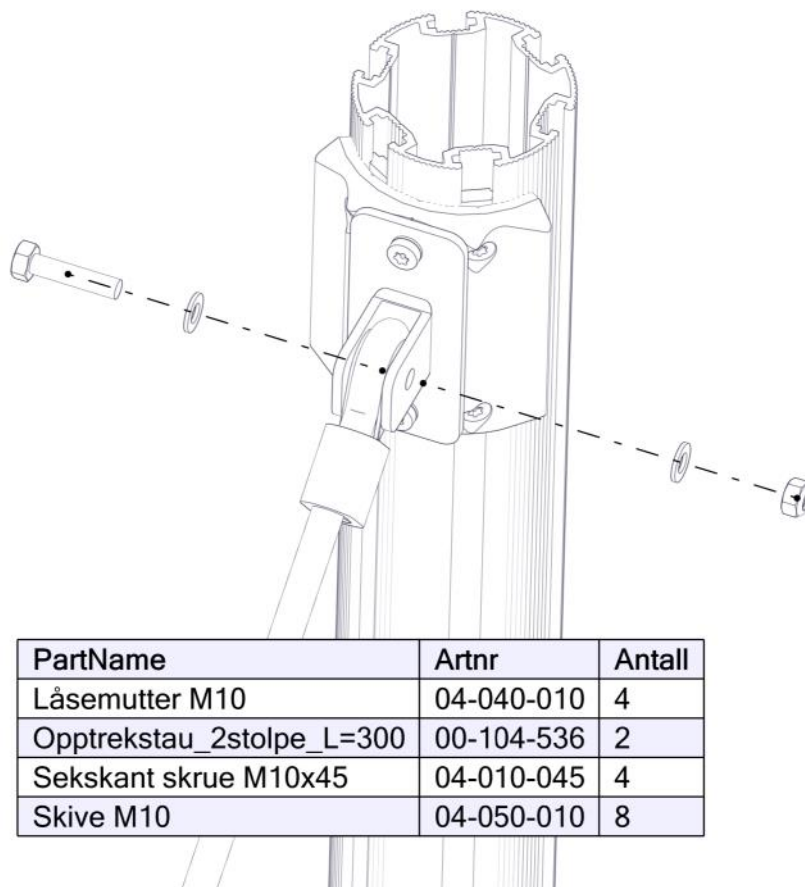

PartName	Artnr	Antall
Låsemutter M10	04-040-010	4
Opptrekstau_2stolpe_L=300	00-104-536	2
Sekskant skrue M10x45	04-010-045	4
Skive M10	04-050-010	8

# Montering av lekeapparatet / Assembly instructions / Montering av lekredskapet

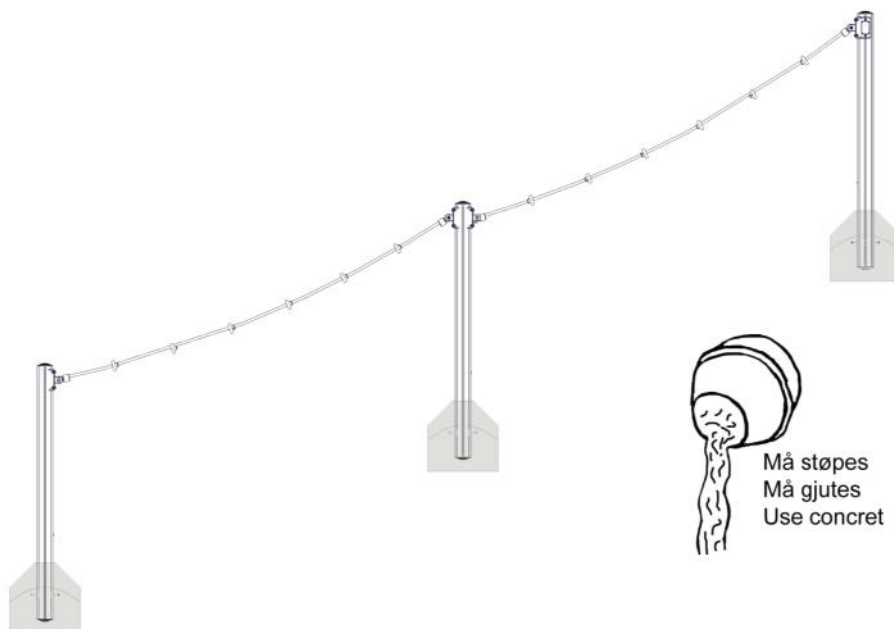
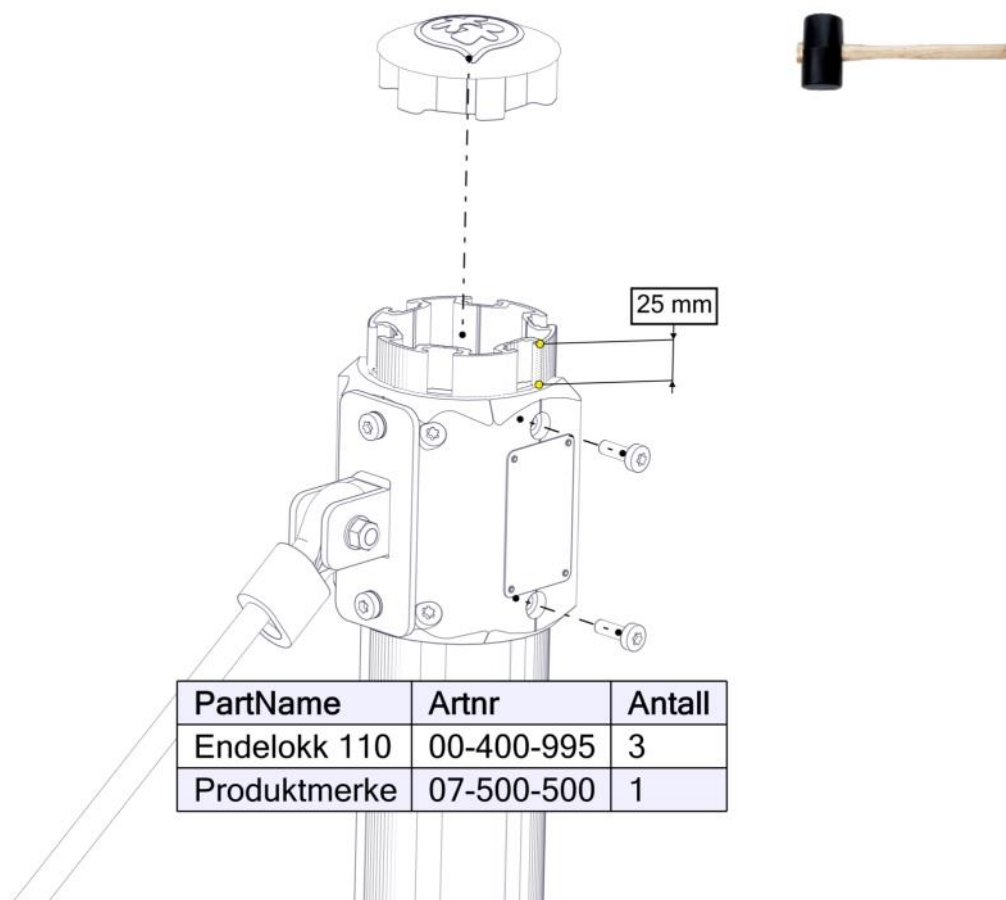





<b>Før utstyret tas i bruk / Before play begins / Innan lekredskapet tas i bruk</b>	
<b>N</b>	<ul style="list-style-type: none"> <li>● Påse at fallunderlag er utlagt i henhold til gjeldende regler eller vår anbefaling</li> <li>● Fjern alle monteringshjelpemidler ( rester av betong, planker, paller, plast, og lignende)</li> <li>● Før utstyret tas i bruk, burde man sjekke at det ikke er fare for at anorakksnorer og lignende som kan hekte seg fast noen steder på lekeapparatet. (Vedlagte snor med dobbe (kneledd) kan brukes til å sjekke at dette er i orden. Se vedlagte veiledning for bruk av denne. Dette gjøres for å oppdage eventuelle feilmonteringer.?)</li> <li>● NB! Bør stå i 2-3 dager før bruk</li> </ul>
<b>EN</b>	<ul style="list-style-type: none"> <li>● Make sure the area and depth of safer surfacing are according to the current standard, or to the manufacturer's recommendation</li> <li>● Make sure all tools and surplus materials are removed before play begins</li> <li>● PS! When complete, allow 2-3 days for the concrete to set before use</li> </ul>
<b>S</b>	<ul style="list-style-type: none"> <li>● Kontrollera att fallunderlag är utlagt enligt gällande regler eller vårt rekommendation</li> <li>● Ta bort alla monteringshjälpmedel (rester av betong, plankor, pallar, plast och liknande)</li> <li>● Innan lekredskapet används, kontrollera att anoracksnoddar eller kläder/delar av kläder eller liknande inte kan fastna i några delar på redskapet. (Den bipackade "knävringen" kan man med fördel användas för denna kontroll.</li> <li>● Detta görs för att upptäcka eventuella felmonteringar.)</li> </ul>



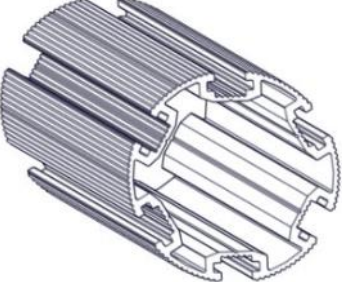

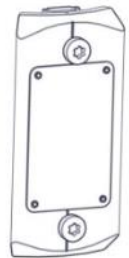
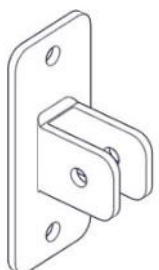



**Boltepakker for / Boltpackage for / Bultpaket för**

Sign. \_\_\_\_\_

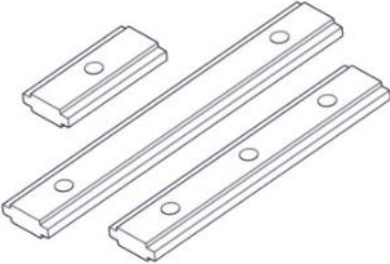
Opptrekstau med 3stolpe L=3000, rød, 30-200-132	Navn	Artnr/ dimensjon	Ant	Lev
	Opptrekstau til 2 stolpe rød L=3000	00-104-536	2	
	Stolpe Ø110 L=1800 (600-1200) Grå	SFA5126/2	3	
	Stolpelokk Ø110	00-400-995	3	
	Produktmerke Med beslag til Ø110 stolpe	07-500-500 (se egen delmontering)	1	
	Beslag Små timble Horizontal	07-200-051	4	
	Beslag 30gr, L=150 4hull, 2 gjenge	07-150-041	4	

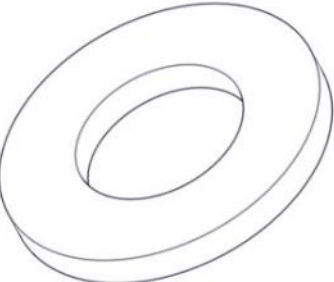
**Boltepakker for / Boltpackage for / Bultpaket för**

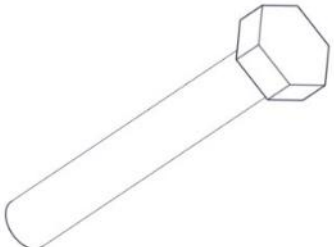
Sign. \_\_\_\_\_

Opptrekstau med 3stolpe L=3000, rød, 30-200-132	Navn	Artnr/ dimensjon	Ant	Lev
	Brikke alu 150x8x23 m/ 2hull	04-060-151	8	
	Torx skrue M8x25	04-000-025	24	
	Skive M8  Skive M10	04-050-008  04-050-010	8  8	
	Låsemutter M10	04-040-010	4	
	Sekskant skrue M10x45	04-010-045	4	
	Fundament Betong 110 lokk_bolter_brik	00-003-111K (se egen delmontering)	3	